

# Amersham ImageQuant 500

## Operating Instructions

Original instructions



# Table of Contents

<b>1</b>	<b>Introduction .....</b>	<b>4</b>
1.1	Important user information .....	5
1.2	About this manual .....	6
1.3	Associated documentation .....	7
<b>2</b>	<b>Safety instructions .....</b>	<b>8</b>
2.1	Safety precautions .....	9
2.2	Labels and symbols .....	16
2.3	Emergency procedures .....	18
<b>3</b>	<b>System description .....</b>	<b>20</b>
3.1	Feature overview .....	21
3.2	Hardware .....	22
3.3	Start screen and capture tab .....	24
3.4	Accessories .....	28
<b>4</b>	<b>Installation .....</b>	<b>29</b>
4.1	Site requirements .....	30
4.2	Unpacking .....	31
4.3	Instrument set up .....	34
4.4	Connection to network or USB flash drive .....	38
4.5	Moving the ImageQuant 500 system .....	42
<b>5</b>	<b>Operation .....</b>	<b>44</b>
5.1	Start the system .....	45
5.2	Operation overview .....	47
5.3	Place the sample on a tray .....	48
5.4	Capture an image .....	51
5.4.1	<i>Chemiluminescence capture</i> .....	52
5.4.2	<i>Fluorescence capture</i> .....	71
5.4.3	<i>Colorimetric capture</i> .....	84
5.4.4	<i>Set the exposure and interval time</i> .....	87
5.5	View the images .....	89
5.6	Save the image .....	94
5.7	File handling .....	97
5.8	Software keypad .....	102
5.9	Shutdown .....	103
<b>6</b>	<b>System settings .....</b>	<b>104</b>
6.1	Introduction to the <b>Settings</b> window .....	105
6.2	<b>Save location</b> .....	107
6.3	Date and time .....	110
6.4	Network .....	111
6.5	Maintenance .....	112

<b>7</b>	<b>Maintenance .....</b>	<b>114</b>
7.1	Safety precautions .....	115
7.2	Cleaning before planned service .....	116
7.3	Cleaning the exterior .....	117
7.4	Cleaning sample trays and filter .....	118
7.5	Regular inspections .....	119
<b>8</b>	<b>Troubleshooting .....</b>	<b>120</b>
8.1	Report an error .....	121
8.2	Problems with the captured image .....	122
8.3	Strange sounds and odors .....	123
8.4	Problems with ImageQuant 500 .....	124
8.5	Problems with ImageQuant 500 Control Software .....	125
<b>9</b>	<b>Reference information .....</b>	<b>126</b>
9.1	Specifications .....	127
9.2	Environmental conditions .....	128
9.3	Recycling information .....	130
9.4	Regulatory information .....	132
9.4.1	<i>Contact information .....</i>	<i>133</i>
9.4.2	<i>European Union and European Economic Area .....</i>	<i>134</i>
9.4.3	<i>Great Britain .....</i>	<i>135</i>
9.4.4	<i>Eurasian Economic Union</i>	
	<i>Евразийский экономический союз .....</i>	<i>136</i>
9.4.5	<i>Regulations for North America .....</i>	<i>138</i>
9.4.6	<i>Regulatory statements .....</i>	<i>139</i>
9.4.7	<i>Declaration of Hazardous Substances (DoHS) .....</i>	<i>140</i>
9.4.8	<i>Other regulations and standards .....</i>	<i>142</i>
9.5	Health and Safety Declaration Form .....	143
	<b>Index .....</b>	<b>145</b>

# 1 Introduction

## About this chapter

This chapter contains information about this manual and associated user documentation, important user information and intended use of the product.

## In this chapter

<b>Section</b>		<b>See page</b>
1.1	Important user information	5
1.2	About this manual	6
1.3	Associated documentation	7



## 1.1 Important user information

### Read this before operating the product



**All users must read the entire *Operating Instructions* before installing, operating or maintaining the product.**

Always keep the *Operating Instructions* at hand when operating the product.

Do not install, operate, or perform maintenance on the product in any other way than described in the user documentation. If you do, you may be exposed or expose others to hazards that can lead to personal injury and you may cause damage to the equipment.

### Intended use of the product

Amersham™ ImageQuant™ 500 is a CCD camera system that produces digital images of chemiluminescent and fluorescent samples or stained gels and membranes. ImageQuant 500 is intended for research use only, and shall not be used in clinical procedures, or for diagnostic purposes.

### Prerequisites

In order to operate ImageQuant 500 in the intended way, the following prerequisites must be fulfilled:

- You have read and understood the safety instructions outlined in this Operating Instruction
- You should be acquainted with the use of general laboratory equipment and with handling of biological materials
- The instrument is installed according to the instructions in this Operating Instruction

## 1.2 About this manual

### Purpose of this manual

The Operating Instructions manual provides information needed to install, operate and maintain the product in a safe way.

### Scope of this manual

This Operating Instruction manual is valid for ImageQuant 500. The illustration below shows the ImageQuant 500 system.



### Typographical conventions

Software items are identified in the text by ***bold italic*** text.

Hardware items are identified in the text by **bold** text.

In electronic format, references in *italics* are clickable hyperlinks.

### Notes and tips

**Note:** *A note is used to indicate information that is important for trouble-free and optimal use of the product.*

**Tip:** *A tip contains useful information that can improve or optimize your procedures.*

## 1.3 Associated documentation

### Introduction

This section describes the user documentation delivered with the product, and how to find related literature that can be downloaded or ordered from Cytiva.

### User documentation for ImageQuant 500

The user documentation is listed in the table below.

Translations of the *Operating Instructions* are provided on the User Documentation CD (or USB flash drive) together with the *Privacy and Security Manual*.

Documentation	Main contents
<i>Amersham ImageQuant 500 Operating Instructions</i> (this document)	Instructions needed to prepare and operate the ImageQuant 500 system in a correct and safe way.  System overview, site requirements, and instructions for moving the system within the same building.  Instructions for basic maintenance and troubleshooting.
<i>Amersham ImageQuant 500 Privacy and Security Manual</i>	Descriptions of the privacy and security aspects of ImageQuant 500 system.
<i>Amersham ImageQuant 500 Site Preparation Guide</i>	Information needed to prepare the site for installation and use of the ImageQuant 500 system.

### User documentation and other literature on the web

User documentation and other literature related to ImageQuant 500 may be downloaded from the web. Follow the steps below to access the documentation.

Step	Action
1	Go to <a href="http://cytiva.com/imagequant">cytiva.com/imagequant</a> .
2	Navigate to <b>RELATED DOCUMENTS</b> .
3	Select the type of document and download the chosen literature.

## 2 Safety instructions

### About this chapter

This chapter describes safety precautions, labels and symbols that are attached to the equipment. In addition, the chapter describes emergency and recovery procedures.

### In this chapter

Section	See page
2.1 Safety precautions	9
2.2 Labels and symbols	16
2.3 Emergency procedures	18

### Important



#### **WARNING**

**Before installing, operating or maintaining the product, all users must read and understand the entire contents of this chapter to become aware of the hazards involved.**

## 2.1 Safety precautions

### Introduction

ImageQuant 500 is powered by mains voltage and handles materials that can be hazardous.

Before installing, operating or maintaining the system, you must be aware of the hazards described in this manual.

**Follow the instructions provided to avoid personal injuries, damage to the product, or to other personnel and equipment in the area.**

The safety precautions in this section are grouped into the following categories:

- General precautions
- Personal protection
- Installing and moving the system
- System operation
- Maintenance

### Definitions

This user documentation contains safety notices (WARNING, CAUTION, and NOTICE) concerning the safe use of the product. See definitions below.



#### **WARNING**

**WARNING** indicates a hazardous situation which, if not avoided, could result in death or serious injury. It is important not to proceed until all stated conditions are met and clearly understood.



#### **CAUTION**

**CAUTION** indicates a hazardous situation which, if not avoided, could result in minor or moderate injury. It is important not to proceed until all stated conditions are met and clearly understood.



#### **NOTICE**

**NOTICE** indicates instructions that must be followed to avoid damage to the product or other equipment.

## General precautions



### WARNING

Do not use the equipment if smoke, strange noises or strange odors can be perceived, or if the equipment becomes unusually hot. This may result in fire or electric shock.

Stop using the equipment immediately, turn off the power switch and unplug the equipment from the power outlet. Contact your local Cytiva representative to request repair.



### WARNING

Do not damage the power supply cord by bending, twisting, heating or allowing them to become pinned under the equipment. Using damaged power cords could result in fire or electric shock.

If the power supply cords are damaged, contact your local Cytiva representative for replacements.



### WARNING

**Access to power switch and power cord with plug.** Do not block access to the power switch and power cord. The power switch must always be easy to access. The power cord with plug must always be easy to disconnect.



### CAUTION

Use of this equipment in other ways than those specified in the user documentation may result in hazardous UV radiation exposure.



### CAUTION

Do not block the vents and ensure that the vents are kept free of dust and dirt. Blockage of the vents can result in overheating of the equipment and malfunction. Place the instrument so that there is at least 20 cm in front of the machine to the walls or other equipment, and 10 cm on all other sides to ensure adequate cooling.

**NOTICE**

This equipment is for laboratory use only.

**Personal protection****CAUTION**

Parts of this equipment may emit UV radiation. Avoid exposure. Wear protective clothing and eyewear. UV radiation can cause severe burns and long-term injury to the skin and eyes.

**CAUTION**

If the door is opened and the interlock has been tampered with, UV and visible light will be emitted.

Do not stare at the light emitted from the light sources. This may impair vision.

**CAUTION**

Always wear gloves, protective glasses and a lab coat or similar when handling samples.

**Installing and moving the instrument****WARNING**

Use a proper power cord that complies with the local laws and regulations, and is delivered by Cytiva. Do not change power cord to inappropriate one.

## 2 Safety instructions

### 2.1 Safety precautions



#### **WARNING**

In USA and Europe (Belgium, Netherlands, Luxembourg, Germany, France, Italy, Denmark, Greece, Spain, Portugal, Austria, Finland, Sweden, Poland, Hungary, Czech, Slovenia, Slovakia, Estonia, Latvia, Lithuania, and Romania), use the proper power cord included in the product package. In other countries, use the proper power cord delivered separately from the product package by Cytiva. Do not change AC power cord to inappropriate one.



#### **WARNING**

Connect the power supply directly to a grounded wall power outlet. The use of extension cords or multiple loads on one electrical outlet could result in fire and electric shock.



#### **CAUTION**

Do not place the equipment on unstable tables or on inclined surfaces, as the equipment could be tipped over or fall, resulting in injury.



#### **CAUTION**

Do not place the equipment or parts in direct sunlight. This may degrade performance.



#### **CAUTION**

Turn off the power switch and remove connecting cables before moving the equipment.



#### **NOTICE**

Do not connect telephone lines to the Ethernet port. Only the EN/IEC 62368-1 standard non-shielded cables are appropriate for connection to this connector.



## System operation

**WARNING**

Do not use the equipment within or near a sink, or in humid or dusty environments. Fire and electric shock could result.

**WARNING**

If thunder can be heard, do not touch the power supply plug, or electric shock could result.

**CAUTION**

Reagents used to prepare the sample should be used in accordance with the manufacturer instructions.

**CAUTION**

Do not lean on the sample door, it might cause breakage to the equipment or the machine to tip over and injure you.

**CAUTION**

When opening or closing the door use the handle. Take care not to catch objects or fingers in the door when closing.

**CAUTION**

Do not place heavy objects on the equipment. These may fall and cause injury.

**CAUTION**

Do not turn the power off during image capture and saving. This may damage the system files.

## 2 Safety instructions

### 2.1 Safety precautions



#### **CAUTION**

Do not leave samples in the equipment after exposure. If left, these may degrade and cause damage.



#### **CAUTION**

Remove all traces of acidic sample solutions to prevent corrosion in the equipment.



#### **NOTICE**

Avoid touching the windows of the light sources and the lens. This may degrade performance.



#### **NOTICE**

Do not scratch or drop the filter. This may degrade performance.



#### **NOTICE**

When using incremental exposure mode, images that are not selected will be deleted at saving.

## Maintenance



#### **WARNING**

Do not attempt to modify the equipment, or fire and electric shock could result.



#### **WARNING**

Do not use excessive amounts of liquids for cleaning the ImageQuant 500, this may result in product malfunction or electric shock.



**CAUTION**

Wear gloves to prevent direct contact with chemical substances.



**CAUTION**

Turn the power switch off before cleaning the inside of the equipment.



**CAUTION**

Unplug the equipment if it will not be used for an extended period.



**CAUTION**

Take care when connecting the power cord. Do not tug at the power cord, and do not handle the connection plugs with wet hands.



**CAUTION**

Do not press too hard onto the surface of the touch screen. This may cause the surface to break and lead to injury.



**NOTICE**

Do not use abrasive cleaning materials, such as a scouring pad, for cleaning. This may scratch the surface.

## 2.2 Labels and symbols

### Introduction



This section describes the product nameplate (label) and other safety and regulatory labels attached to the product.

### System label

The system label is located on the back of the equipment. The system label identifies the equipment and shows electrical data, regulatory compliance, and warning symbols.

### Description of symbols on the system

The following symbols and text may be present on the system:

Symbol / text	Description
	<b>Warning!</b> Read the user documentation before using the system. Do not open any covers or replace parts unless specifically stated in the user documentation.
	This symbol indicates the connection point for the USB flash drive on ImageQuant 500
<b>Frequency</b> <b>Supply Voltage</b> <b>Max. Power</b>	Electrical requirements: <ul style="list-style-type: none"> <li>• Frequency (Hz)</li> <li>• Supply Voltage (VAC ~ )</li> <li>• Max. Power (W)</li> </ul>
~	Alternating current.
<b>Protection Class</b>	Degree of protection provided by the enclosure.
<b>Manufacturing Year and Month</b>	Year (YYYY) and month (MM) of manufacture.

## Position of labels and symbols

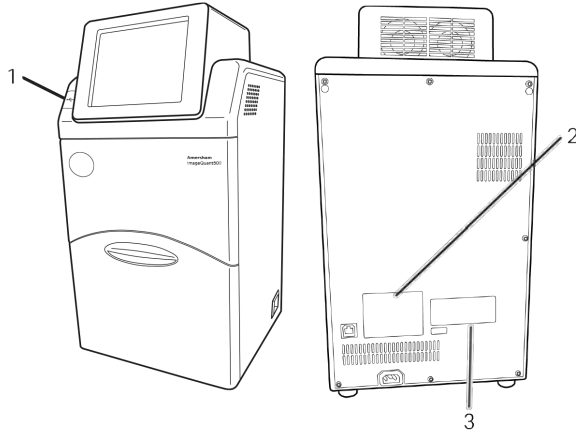

Part	Description
1	USB label
2	System label
3	FCC and ICES-003 label

## 2.3 Emergency procedures

### Introduction

This section describes how to shut down the ImageQuant 500 in an emergency situation, and the procedure for restarting the system.

The section also describes the result in the event of power failure.

### Precautions



#### **WARNING**

**Access to power switch and power cord with plug.** Do not block access to the power switch and power cord. The power switch must always be easy to access. The power cord with plug must always be easy to disconnect.

### Emergency shutdown

In case of emergency:

<b>Step</b>	<b>Action</b>
1	Turn off the power by pushing the <b>Power</b> switch to the <b>O</b> position on the bottom right hand side of the instrument.

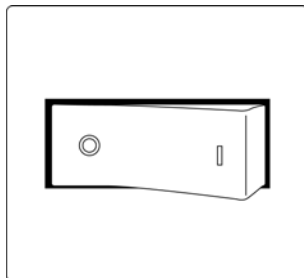

2	Disconnect the power cord from the wall socket.
---	---

### Power failure

The following table describes the consequences of a power failure.

Power failure to...	will result in...
<b>ImageQuant 500 instrument</b>	<ul style="list-style-type: none"><li>• The run is interrupted immediately</li><li>• Any image capture in process will be lost. Only saved data will be available on reboot.</li><li>• The <b>Power</b> indicator switches off.</li></ul>
<b>Computer</b>	<ul style="list-style-type: none"><li>• The <b>Power</b> indicator on the Instrument control panel displays blue.</li><li>• The run is interrupted immediately.</li><li>• If a run was in process, no image data will be saved.</li></ul>

# 3 System description

## About this chapter

This chapter contains information on the ImageQuant 500 hardware components, accessories, start screen, and a feature overview.

## In this chapter

<b>Section</b>		<b>See page</b>
3.1	Feature overview	21
3.2	Hardware	22
3.3	Start screen and capture tab	24
3.4	Accessories	28



## 3.1 Feature overview

The following features are offered by the ImageQuant 500:

- A highly sensitive CCD camera with 8.3 megapixels
- Semi-auto and incremental exposure modes provide the best possible images in areas of interest
- Fast cooling capacity
- Easy to install and ready to use within 5 minutes after start-up
- Touch screen interface
- Chemiluminescence imaging with high sensitivity
- Generation of a combined color image of a chemiluminescence sample image and a white light image of a color marker
- Fluorescence imaging using blue and UV Epi light sources
- Photos of stained gels or membranes obtained by white light illumination
- Intuitive design with easy to use image analyzing tools

## 3.2 Hardware

### ImageQuant 500 exterior

The following illustrations show the main hardware components on the outside of ImageQuant 500.

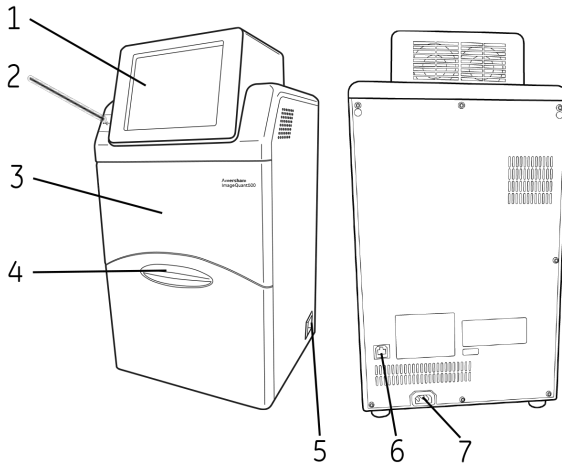

Part	Name	Description
1	Touch screen	User interface
2	USB port	USB 2.0 port for connection of USB flash drive  <b>Note:</b> <i>Password protected USB flash drives are not supported.</i>
3	Body	Instrument dark box
4	Door	Instrument door
5	Power switch	Toggle switch: <b>I</b> Power ON <b>O</b> Power OFF
6	Ethernet port	Connector for network cable (Ethernet)
7	Power connector	Connector for AC power cord

## ImageQuant 500 interior

The following illustrations show the main hardware components on the inside of ImageQuant 500.

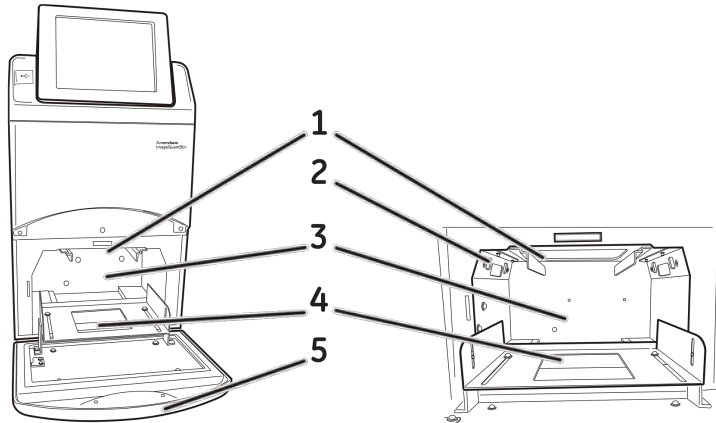

Part	Name	Description
1	Filter loading slot	Slot for orange filter. Used for detection of fluorescence above 560 nm.
2	Epi light sources	Light sources: <ul style="list-style-type: none"> <li>• Combined Blue (460 nm) and UV (365 nm) Epi light</li> <li>• White (470 to 635 nm) Epi light</li> </ul>
3	Sample chamber	Dark compartment where the tray is placed
4	Tray guide	Supports and positions the tray
5	Door	Instrument door

## 3.3 Start screen and capture tab

### Start screen, capture tab (**Auto**)

The **Capture** tab is shown on the start screen when the ImageQuant 500 startup is complete. This screen allows the selection of capture methods and exposure settings. The **Capture** tab has automatic exposure time, **Auto**, as default at startup.

The following illustration and table show the main components of the **Capture** tab when automatic exposure time is selected.

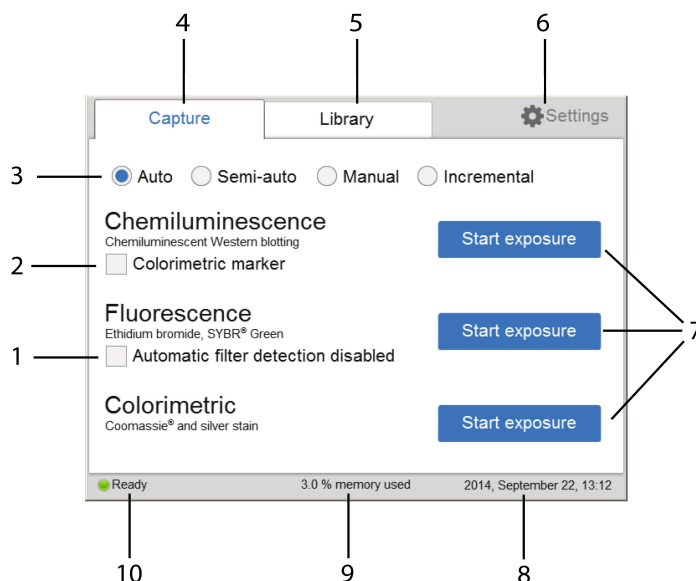

Part	Function
1	Check the <b>Automatic filter detection disabled</b> box if a fluorescence sample is larger than the image area (15×10 cm) or the automatic filter detection fails.
2	Check the <b>Colorimetric marker</b> box when colorimetric markers are used with chemiluminescent samples.
3	Buttons for selecting exposure options: <b>Auto</b> , <b>Semi-auto</b> , <b>Manual</b> , and <b>Incremental</b> . At startup, the automatic exposure time ( <b>Auto</b> ) is set to default.  <b>Note:</b> <i>For more information about the exposure modes, see <a href="#">Section 5.4.1 Chemiluminescence capture, on page 52</a> and <a href="#">Section 5.4.2 Fluorescence capture, on page 71</a>.</i>
4	<b>Capture</b> tab: choose imaging method and start the capture.
5	<b>Library</b> tab: image file handling.

Part	Function
6	<b>Settings</b> icon: adjust system and network related settings.
7	<p><b>Start exposure</b> buttons for one of the following methods:</p> <ul style="list-style-type: none"> <li>• Chemiluminescence (with or without colorimetric marker)</li> <li>• Fluorescence (with or without automatic filter detection)</li> <li>• Colorimetric</li> </ul> <p>Tap on any of the <b>Start exposure</b> buttons to capture an image.</p>
8	Date and time. The date and time can be set in <b>Settings</b> , see <a href="#">Section 6.3 Date and time, on page 110</a> for further instructions.
9	Number of files stored on the device, as % available memory.
10	Status of the ImageQuant 500: <b>Ready, Not Ready</b> or <b>Capture in progress</b> .

### Capture tab (Semi-auto)

The following illustration and table shows the main components of the **Capture** tab when the **Semi-auto** radio button is selected.

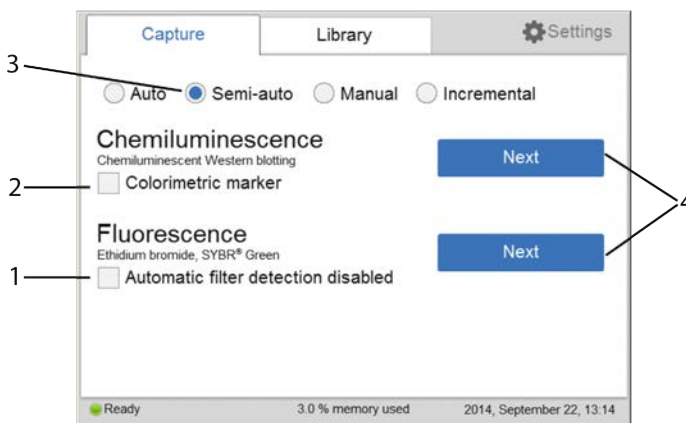

Part	Function
1	Check the <b>Automatic filter detection</b> box when a fluorescence sample is larger than the image area (15×10 cm) or if the automatic filter detection fails.
2	Check the <b>Colorimetric marker</b> box when colorimetric markers are used with chemiluminescent samples.
3	Button for <b>Semi-auto</b> . A short pre-exposure is performed which results in an image. This allows you to select the area of the sample image to focus on. The software automatically calculates the optimal exposure time for the specific area.

### 3 System description

#### 3.3 Start screen and capture tab

Part	Function
4	<b>Next</b> button to set a specific area of interest in the fluorescence or chemiluminescence samples (with or without colorimetric markers) samples.

#### Capture tab (*Manual*)

The following illustration and table show the components of the **Capture** tab when the **Manual** radio button is selected.

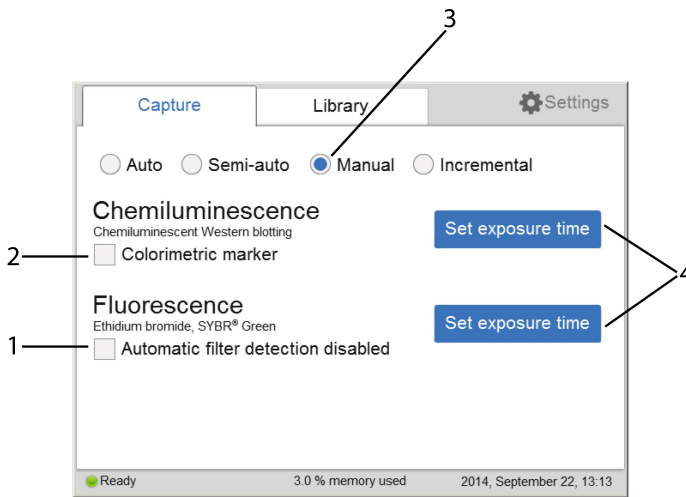

Part	Function
1	Check the <b>Automatic filter detection disabled</b> check box when a fluorescence sample is larger than the image area (15×10 cm) or if the automatic filter detection fails.
2	Check the <b>Colorimetric marker</b> check box when colorimetric markers are used with chemiluminescent samples.
3	Radio button for <b>Manual</b> . The exposure time will be set manually, see <a href="#">Section 5.4.4 Set the exposure and interval time, on page 87</a> for more information on how to set the time.
4	Tap the <b>Set exposure time</b> button for fluorescence or chemiluminescence samples (with or without colorimetric markers) to set the exposure time.

## Capture tab (*Incremental*)

The following illustration and table shows the components of the **Capture** tab when **Incremental** radio button is selected.

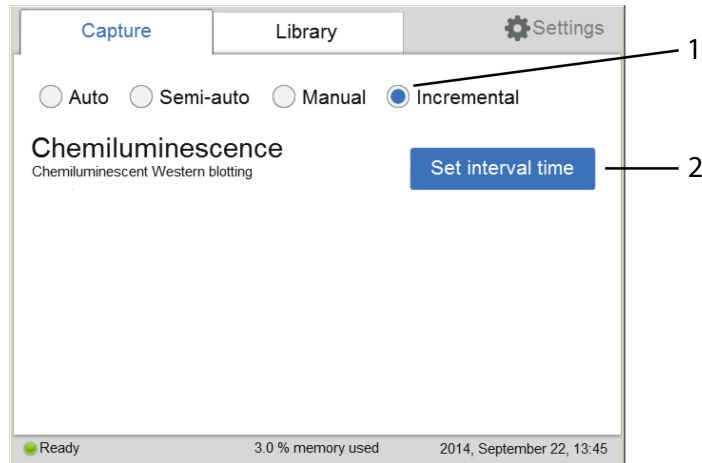





Part	Function
1	The <b>Incremental</b> radio button allows the capture of sequential images.
2	The <b>Set interval time</b> button is used to set the number of repetitions and interval times between exposures to capture sequential images for chemiluminescence samples.

### 3 System description

#### 3.4 Accessories

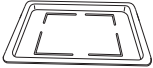
## 3.4 Accessories

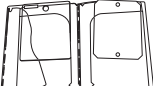
The following table show the accessories included in the ImageQuant 500 system.

Part	Description	Article Number
	Protein tray	29005067
	DNA tray	29005066
	White insert for gels or membranes with colorimetric marker and stains	29005069
	Orange filter (560LP) for detection of fluorescence above 560 nm	29005068
	Accessories case	29005070
	AC power cord (For North America)	80648033
	AC power cord (For Europe)	19244801



# 4 Installation

## About this chapter

This chapter contains information on how to unpack, install, and transport the ImageQuant 500 system.

## In this chapter

<b>Section</b>		<b>See page</b>
4.1	Site requirements	30
4.2	Unpacking	31
4.3	Instrument set up	34
4.4	Connection to network or USB flash drive	38
4.5	Moving the ImageQuant 500 system	42

## 4.1 Site requirements



### WARNING

**Access to power cord.** Do not block access to the power cord. The power cord must always be easy to disconnect.



### WARNING

**Protective ground.** The product must always be connected to a grounded power outlet.

The following table gives a summary of power supply and environmental requirement.

Parameter	Requirement
Supply voltage	100 to 240 V~
Phases	Single phase (with 3P ground pole)
Frequency	50/60 Hz
Maximum power	200 W
Grounding	ImageQuant 500 must be connected to a grounded AC power outlet.  It is necessary to connect the AC power cord of this equipment to a 2P+E type AC outlet for the safety of human bodies, external noise protection and stable operation.
Ambient temperature	Operation: 18°C to 28°C Transportation/Storage: -25°C to 70°C
Placement	The placement of the ImageQuant 500 must fulfill the following requirements: <ul style="list-style-type: none"><li>• A stable laboratory bench, with a load capacity of 490 N (50 kg) or higher, and levelness within 2°</li><li>• At least 20 cm of free space in front of the machine and 10 cm on all other sides</li><li>• Out of direct sunlight</li></ul>
Humidity	Operation: 15% to 70%, non-condensing Transportation/Storage: 5% to 95%, non-condensing

## 4.2 Unpacking

### Visual inspection

- Check that all equipment is in the crate according to the packing list.
- Check the equipment for damage and document it carefully if found, before starting installation.

If any equipment is missing or damage is found, contact your Cytiva representative immediately.

### Unpacking instruction

Follow the instructions, to unpack the ImageQuant 500 system:

Step	Action
------	--------

- |   |                              |
|---|------------------------------|
| 1 | Cut the polypropylene bands. |
|---|------------------------------|

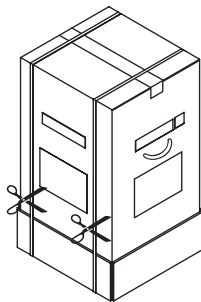

- |   |  |
|---|--|
| 2 | Remove the tape at the top of the box. |
|---|--|

4 Installation  
4.2 Unpacking

**Step**    **Action**

---

- 3        Open the top of the box and remove the *Operating Instructions* and the upper padding.

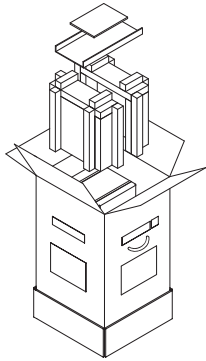

- 4        Remove the upper packaging of the box from the bottom packaging, then lift the inner box out of the bottom padding and packaging.

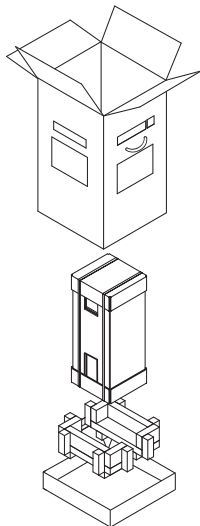

Step	Action
------	--------

- |   |   |
|---|---|
| 5 | Cut the polypropylene bands of the inner box. |
|---|---|

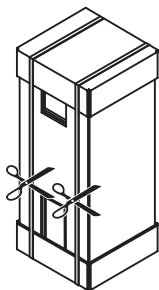

- |   |   |
|---|---|
| 6 | Remove the top packaging of the box, the accessories box, and the packaging surrounding the instrument. |
|---|---|

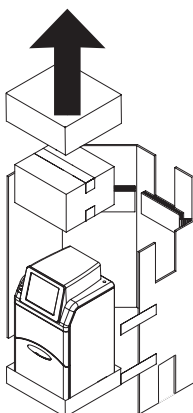

- |   |                             |
|---|-----------------------------|
| 7 | Unpack the accessories box. |
|---|-----------------------------|

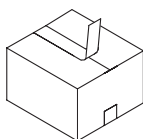

- |   |  |
|---|--|
| 8 | Continue to the next section to set up ImageQuant 500. |
|---|--|

## 4.3 Instrument set up



### CAUTION

Do not place the equipment on unstable tables or on inclined surfaces, as the equipment could be tipped over or fall, resulting in injury.



### CAUTION

Do not place the equipment or parts in direct sunlight. This may degrade performance.



### CAUTION

Do not block the vents and ensure that the vents are kept free of dust and dirt. Blockage of the vents can result in overheating of the equipment and malfunction. Place the instrument at least 20 cm in front and 10 cm on all other sides away from walls or other equipment to ensure adequate cooling.

Follow the instructions, to set up ImageQuant 500.

Step	Action
------	--------

- |   |  |
|---|--|
| 1 | Lift ImageQuant 500 out of the bottom packaging and place it on a workbench. |
|---|--|

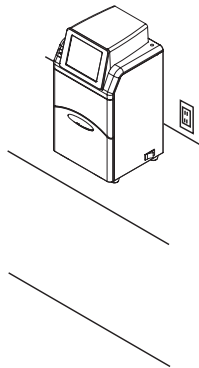

Step	Action
2	Connect the AC power cord.

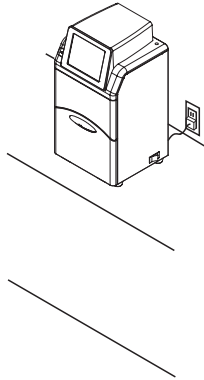

**WARNING**

Use a proper power cord that complies with the local laws and regulations, and is delivered by Cytiva. Do not change power cord to inappropriate one.



**WARNING**

In USA and Europe (Belgium, Netherlands, Luxemburg, Germany, France, Italy, Denmark, Greece, Spain, Portugal, Austria, Finland, Sweden, Poland, Hungary, Czech, Slovenia, Slovakia, Estonia, Latvia, Lithuania, and Romania), use the proper power cord included in the product package. In other countries, use the proper power cord delivered separately from the product package by Cytiva. Do not change AC power cord to an inappropriate one.



**WARNING**

Connect the power supply directly to a grounded wall power outlet. The use of extension cords or multiple loads on one electrical outlet could result in fire and electric shock.

Step	Action
------	--------

- |   |  |
|---|--|
| 3 | Turn on the power to the instrument by pushing the power switch to the I position. |
|---|--|

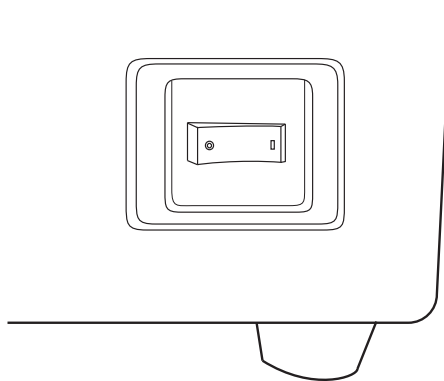

*Result:*

ImageQuant 500 self-diagnostic starts and a screen with the message **500 initializing...** appears.

- |   |   |
|---|---|
| 4 | Wait until the start screen is displayed and the message in the lower left corner reads <b>Ready</b> , see image below. |
|---|---|

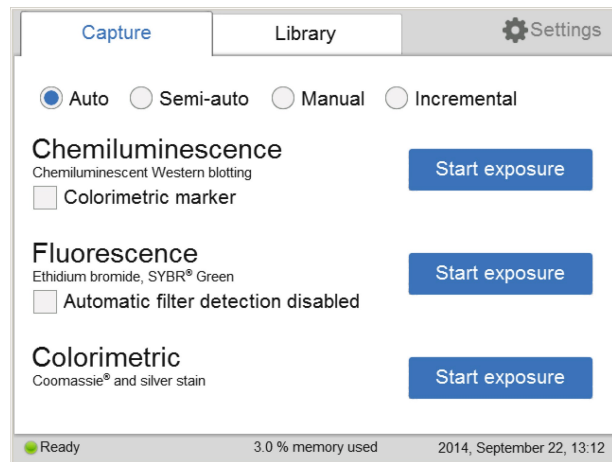

*Result:*

Start-up is now finished.

- |   |  |
|---|--|
| 5 | Set the date and time by tapping on <b>Settings</b> and choosing <b>Date &amp; Time</b> . For detailed information, go to <a href="#">Section 6.3 Date and time, on page 110</a> . |
|---|--|



<b>Step</b>	<b>Action</b>
6	If desired, go to <a href="#">Section 4.4 Connection to network or USB flash drive, on page 38</a> to install a network.

## 4.4 Connection to network or USB flash drive

### Virus protection

The ImageQuant 500 does not have any antivirus software. To avoid disturbances or issues related to computer viruses, the following precautions should be taken:

- Do not connect the ImageQuant 500 directly to the internet. Use an appropriate hardware firewall to protect the instrument from internet related security threats.
- Be careful when connecting USB flash drives to the instrument. If possible, use antivirus software installed on an external PC to scan the USB drives for viruses.
- If you, by any reason, suspect that the instrument has been infected by a computer virus, restart the ImageQuant 500 as soon as possible. This should remove the virus from the instrument.

### Connect a USB flash drive

The USB flash driver is automatically installed when the USB flash drive is connected to ImageQuant 500.

**Note:** *Password protected USB flash drives are not supported.*

### Connect to a network



#### NOTICE

Do not connect telephone lines to the Ethernet port.

Only the EN/IEC 62368-1 standard non-shielded cables are appropriate for connection to this connector.

Connection to a network enables the addition of **Save locations** and the use of the **ImageQuant 500 web tool**, for more information see [Section 6.2 Save location, on page 107](#) and [ImageQuant 500 web tool on page 100](#).

There are two options for network set up:

- DHCP
- Static IP

If a DHCP network is used the IP address will be assigned automatically by the DHCP server. If a Static IP network is used the network details have to be entered manually.

The following subsections give the information necessary to connect to a DHCP network and a Static IP network.

### Open the Network window

Follow the instructions below, to open the **Network** window:

Step	Action
------	--------

- 1 Tap the **Settings** icon in the start screen.

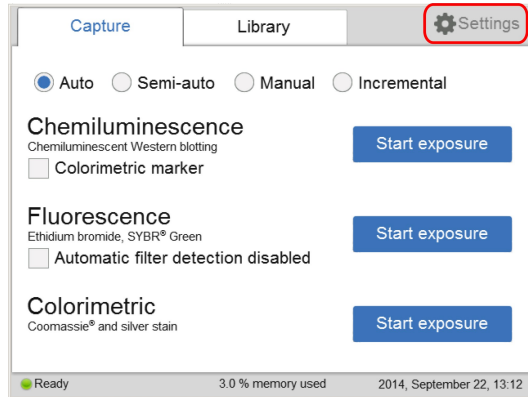

- 2 Tap the **Network** button.

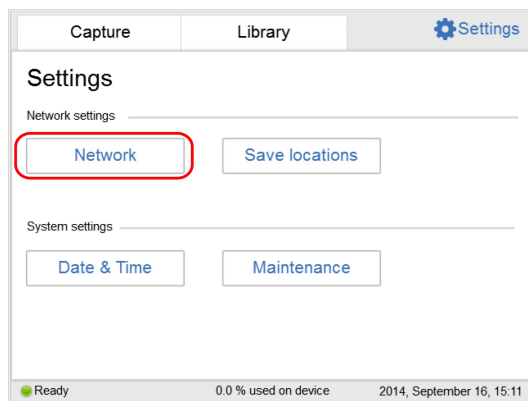

- 3 If a connection to a DHCP network is being established, continue to [Connect to a DHCP network on page 39](#).  
If a connection to a Static IP network is being established, continue to [Connect to a Static IP network on page 40](#).

## Connect to a DHCP network

Follow the instructions below, to connect to a DHCP network:

Step	Action
------	--------

- 1 Connect the network cable to the Ethernet port on ImageQuant 500.

## 4 Installation

### 4.4 Connection to network or USB flash drive

Step	Action
------	--------

- |   |  |
|---|--|
| 2 | Tap the <b>DHCP</b> button in the <b>Network</b> window. |
|---|--|

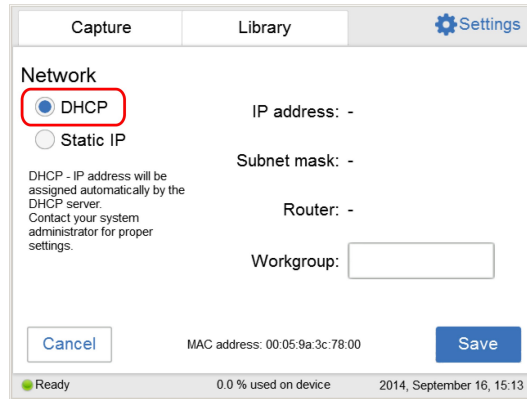

- |   |  |
|---|--|
| 3 | If desired, tap the <b>Workgroup</b> field and use the keypad to type the workgroup. |
|---|--|

**Note:**

For detailed information on how to use the keypad, go to [Keypad on page 102](#).

- |   |                             |
|---|-----------------------------|
| 4 | Tap the <b>Save</b> button. |
|---|-----------------------------|

**Result:**

An automatic connection to the DHCP network is established within a couple of seconds.

## Connect to a Static IP network

Follow the instructions below, to connect to a Static IP network:

Step	Action
------	--------

- |   |   |
|---|---|
| 1 | Connect the network cable to the Ethernet port on ImageQuant 500. |
|---|---|

Step	Action
2	Tap <b>Static IP</b> in the <b>Network</b> window.

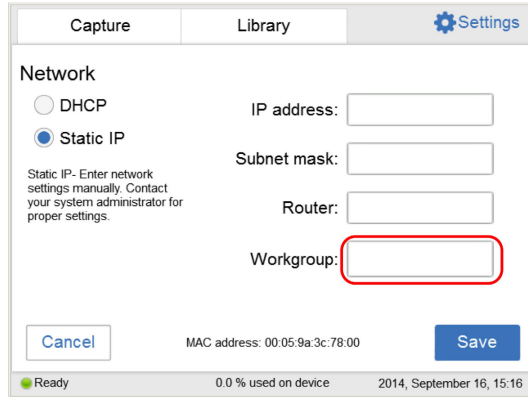

- 3 Tap the:
- **IP address** field and use the keypad to enter the IP address.
  - **Subnet mask** field and use the keypad to enter the subnet mask.

If desired, tap the:

- **Router** field and use the keypad to enter the router.
- **Workgroup** field and use the keypad to enter the workgroup.

**Note:**

*For detailed information on how to fill in the network properties and how to use the keypad, see [Section 6.4 Network, on page 111](#) and [Keypad on page 102](#) respectively.*

- 4 Tap the **Save** button to save the changes.

**Result:**

The connection to the Static IP network is established within a couple of seconds.

## 4.5 Moving the ImageQuant 500 system

### Introduction

This section provides instructions for moving the ImageQuant 500 system within and between sites.

For transport over longer distances, pack the instrument securely in a protective box. Use the original packing material if possible.

Contact Cytiva for information on moving the system over longer distances.

### Safety precautions



#### **WARNING**

When moving the instrument for maintenance or other purposes, disconnect all cables from wall sockets and separate equipment so that the cables do not pull on the instrument or equipment.

### Preparing to move ImageQuant 500 system

The ImageQuant 500 weighs 15 kg.

Follow the instructions below to prepare ImageQuant 500 system for moving.

<b>Step</b>	<b>Action</b>
1	Turn off the instrument.
2	Disconnect the power cord, USB flash drive and network cable, if present.
3	Remove any loose parts (e.g tray, filter and white insert) from the inside of ImageQuant 500.

Move the instrument carefully, using appropriate lifting and moving equipment.

### Re-installing ImageQuant 500 system at a new location

Follow the instructions below to re-install ImageQuant 500 system at the new location.

<b>Step</b>	<b>Action</b>
1	Check that the new location fulfils the site requirements.
2	Use the adjustable feet to compensate for any unevenness in the bench surface.

<b>Step</b>	<b>Action</b>
3	Reconnect the system units.
4	(Recommended) Test the system performance.

### **Performance tests**

Performance tests are recommended after moving and re-installing ImageQuant 500 system to confirm that the system is working correctly. Performance tests are described in the *ImageQuant 500 User Manual*.

# 5 Operation

## About this chapter

This chapter describes how to start and operate the ImageQuant 500 system.

## In this chapter

<b>Section</b>		<b>See page</b>
5.1	Start the system	45
5.2	Operation overview	47
5.3	Place the sample on a tray	48
5.4	Capture an image	51
5.5	View the images	89
5.6	Save the image	94
5.7	File handling	97
5.8	Software keypad	102
5.9	Shutdown	103



## 5.1 Start the system

### Introduction

This section describes how to start the system and connect the ImageQuant 500 instrument to ImageQuant 500 software.

### Start ImageQuant 500

Follow the instructions below to start the ImageQuant 500 instrument.

Step	Action
1	Push the power switch on the right side of the instrument to the <b>I</b> position.

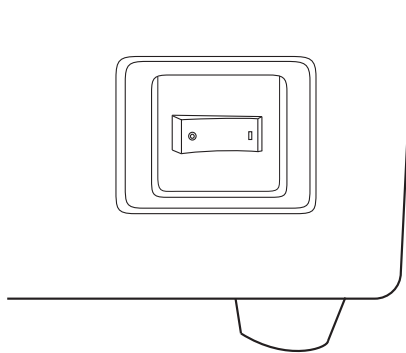

*Result:*

ImageQuant 500 self-diagnostic starts and a screen with the message **500 initializing...** appears.

2	Wait until the start screen is displayed and the message in the lower left corner reads <b>Ready</b> , see image below.
---	---

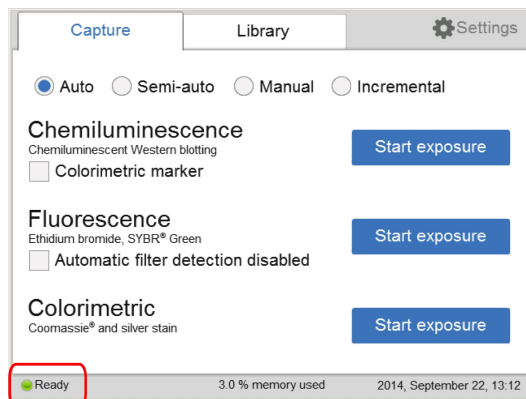

## 5 Operation

### 5.1 Start the system

<b>Step</b>	<b>Action</b>
-------------	---------------

---

*Result:*

Start-up is now finished.

**Note:**

*The self diagnostics will finish within 5 minutes, with the exception of connection to a network environment which may take longer.*

---

## 5.2 Operation overview

### Operation flow chart

The general flow of operation is as follows:

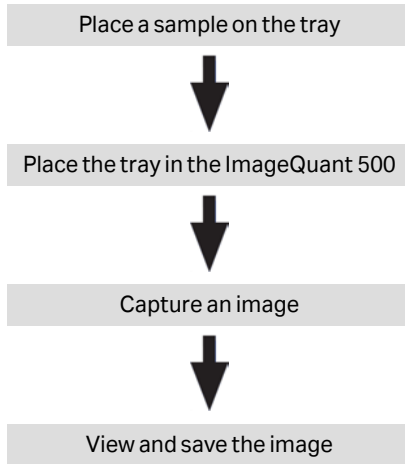

## 5.3 Place the sample on a tray

### Place the sample

This section describes how to choose the appropriate sample tray, how to place the sample on the tray and how to place the tray in ImageQuant 500.

Step	Action
------	--------

- |   |   |
|---|---|
| 1 | Select a suitable sample tray and accessory for the type of capture to be performed from the table below. |
|---|---|

Capture method	Sample Type	Tray	White insert	Orange filter
Chemiluminescence	Membrane	Protein tray	No	No
Chemiluminescence with colorimetric marker	Membrane	Protein tray	Yes	No
Fluorescence	Gel (e.g. Deep Purple)	Protein tray	No	Yes
	Gel (e.g. EtBr/ SYBR™ Green) <sup>1</sup>	DNA tray	No	Yes
	Membrane (e.g. Deep Purple)	Protein tray	No	Yes
Colorimetric	Gel (e.g. Coomassie™ Brilliant Blue and Silver stain)	Protein tray	Yes	No
	Membrane (e.g. Ponceau)	Protein tray	Yes	No

<sup>1</sup> To minimize contamination, we recommend the exclusive use of the DNA tray for DNA stains such as EtBr and SYBR Green.

**Note:**

*With regards to third party patents related to sample preparation etcetera, we recommend that you consult a lawyer or patent attorney for obtaining appropriate licenses.*

Step	Action
2	Place the sample and if applicable, the white insert, on the sample tray in accordance with the relevant instruction below.

#### Place membrane or gel on protein tray

Place the gel or membrane within the outlines on the protein tray. Take care not to cover the surrounding area which is used for automatic filter detection and for setting the auto contrast.

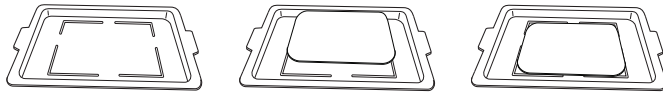

#### Place white insert and membrane or gel on protein tray

Place the white insert on the protein tray. Place the sample on the white insert, try to place the sample so that it fits within the outlines on the protein tray below the white insert. Take care not to cover the holes of the white insert which are used for automatic filter detection and for setting the auto contrast.

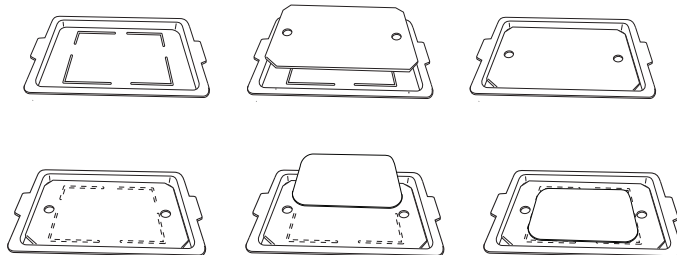

#### Place gel on DNA tray

Place the gel within the outlines on the DNA tray. Take care not to cover the surrounding area which is used for automatic filter detection and for setting the auto contrast.

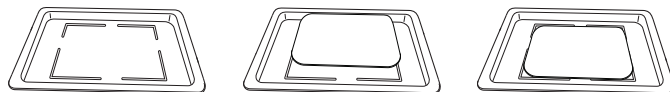

3	Open the door of ImageQuant 500.
---	----------------------------------

## 5 Operation

### 5.3 Place the sample on a tray

Step	Action
------	--------

- |   |  |
|---|--|
| 4 | Place the tray in ImageQuant 500. Use the tray guide to ensure correct placement. The image below shows the protein tray placed in ImageQuant 500. |
|---|--|

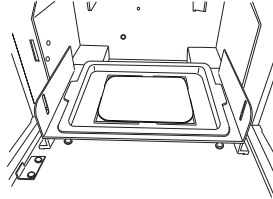

- |   |  |
|---|--|
| 5 | If capturing an image of a fluorescent sample, insert the orange filter. |
|---|--|

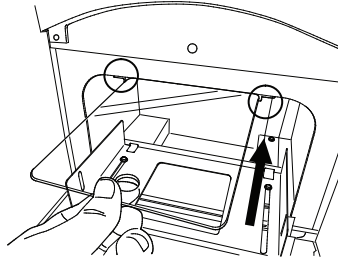

- |   |                                   |
|---|-----------------------------------|
| 6 | Close the door of ImageQuant 500. |
|---|-----------------------------------|

## 5.4 Capture an image

### Introduction

This section contains all the necessary information to capture an image using one of the following methods:

- Chemiluminescence (with or without colorimetric marker)
- Fluorescence
- Colorimetric

### In this section

<b>Section</b>	<b>See page</b>
5.4.1 Chemiluminescence capture	52
5.4.2 Fluorescence capture	71
5.4.3 Colorimetric capture	84
5.4.4 Set the exposure and interval time	87

## 5 Operation

### 5.4 Capture an image

#### 5.4.1 Chemiluminescence capture

## 5.4.1 Chemiluminescence capture

### Introduction

The instrument captures the light that is emitted during the chemical reaction on the membrane. When a colorimetric marker is present in the sample, an additional color image can be captured using a white light source.

### Chemiluminescence exposure options

There are four exposure options for chemiluminescence capture. The table below suggests the options to use in different situations.

When...	Then...
An optimal dynamic range is required:	Select <b>Auto</b> for automatic exposure. A short pre-exposure is performed to determine the signal intensity. The system will use this information to calculate which exposure time will give the highest possible signal below saturation to enable accurate quantification of the sample.
A specific area of a sample is of interest:	Select <b>Semi-auto</b> . A short pre-exposure is performed which results in an image. This allows you to select the area of the sample image to focus on. The software automatically calculates the optimal exposure time for the specified area.
The intensity of the image is inadequate after automatic exposure or a known exposure time is required:	Select <b>Manual</b> exposure and set the exposure time manually.
A sequence of images is required:	Select <b>Incremental</b> exposure and set the number of repetitions and interval time between exposures to capture sequential images.

**Note:** Do not open the door during exposure as this will stop the exposure and the data will not be saved.

### Chemiluminescence with automatic exposure time

Follow the instructions below to perform chemiluminescence capture using automatic exposure time.



**Step Action**

- 1 In the **Capture** tab, select the **Auto** button (set as default).

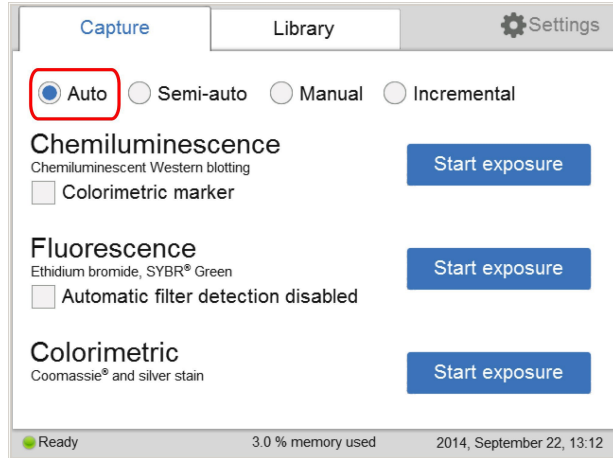

- 2 If your sample contains a colorimetric marker, then check the **Colorimetric marker** box.

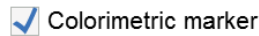

- 3 Tap **Start exposure** for Chemiluminescence.

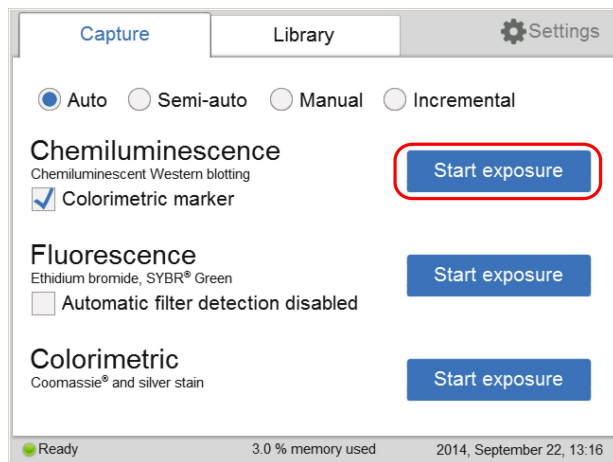

## 5 Operation

### 5.4 Capture an image

#### 5.4.1 Chemiluminescence capture

Step	Action
------	--------

*Result:*

Exposure starts after pre-exposure and a progress bar appears on the screen. This indicates the remaining time for the imaging process, the exposure selected, and the actual exposure time.

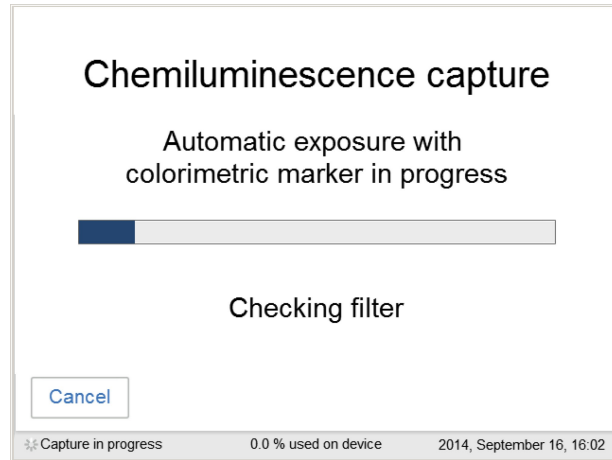

**Note:**

Selecting **Cancel** will cancel the exposure and the **Capture** view will appear.

- 4 When the exposure is finished the image view appears displaying the image. ImageQuant 500 creates a folder containing image files that can be saved. For details see [File formats, on page 95](#).

**Step Action**

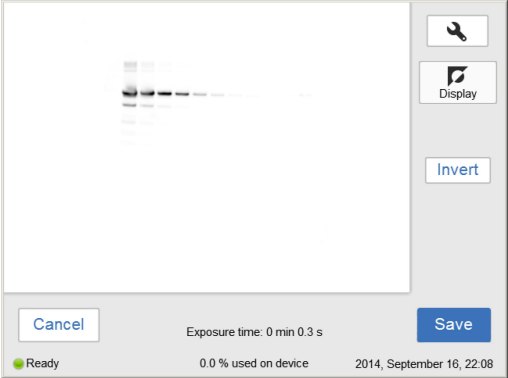
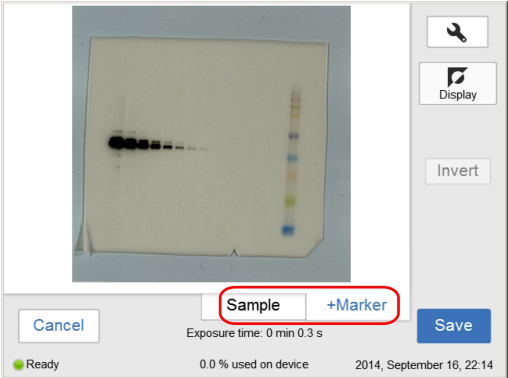
If...	Then...
<p><b>No colorimetric marker was used</b></p>	<p>The resulting image is displayed in gray scale.</p> 
<p><b>Colorimetric marker was used</b></p>	<p>The resulting images are displayed under <b>Sample</b> and <b>+Marker</b> tabs.</p> <ul style="list-style-type: none"> <li>• Select the relevant tab for the image you wish to display. A selected tab is highlighted with blue text and frame.</li> <li>• Select <b>Sample</b> to see the sample without colorimetric marker.</li> <li>• Select <b>+Marker</b> to see a composite color image of the sample and colorimetric marker images.</li> </ul> 

5 Tap **Save** to save the images. For other options see [Options after image capture, on page 70](#).

## 5 Operation

### 5.4 Capture an image

#### 5.4.1 Chemiluminescence capture

## Chemiluminescence with semi-automatic exposure

Follow the instructions below to perform chemiluminescence capture using semi-automatic exposure time.

Step	Action
------	--------

- 1 In the **Capture** tab select the **Semi-auto** button.

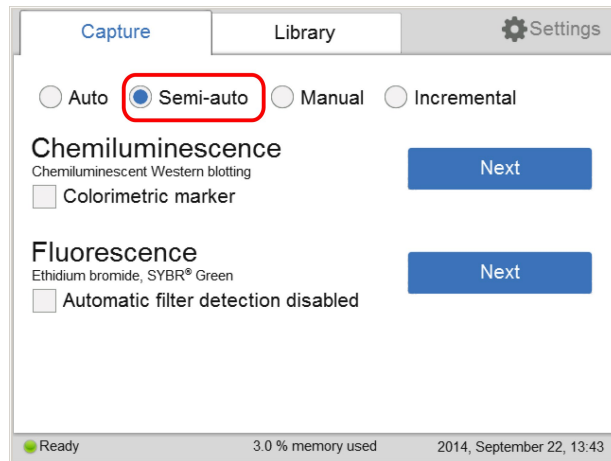

- 2 If your sample contains a colorimetric marker, then check the **Colorimetric marker** box.

Colorimetric marker

- 3 Tap **Next** for Chemiluminescence.

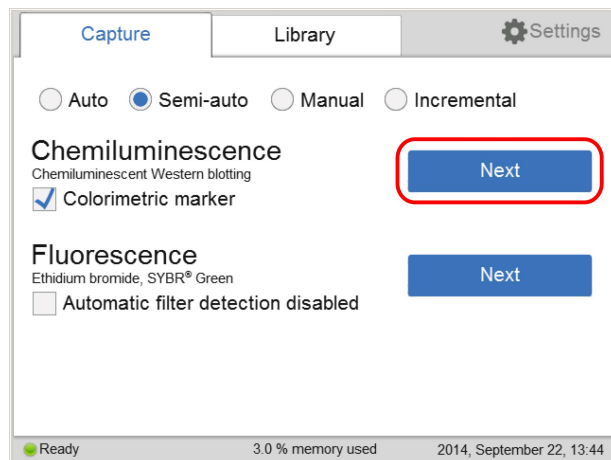

**Step**    **Action**

---

*Result:*

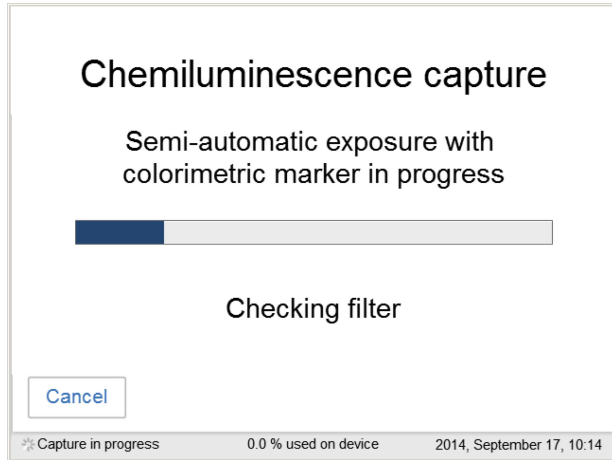

When the pre-exposure is finished a low resolution preview image is displayed.

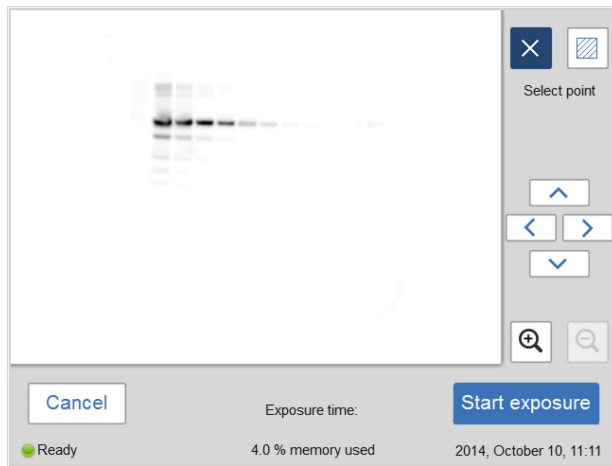

- 4 Use the zoom tools and arrows to get an optimal view of the area of interest.

Choose  to zoom in.

## 5 Operation

### 5.4 Capture an image

#### 5.4.1 Chemiluminescence capture

Step	Action
------	--------

	Choose  to zoom out.
--	---

**Note:**

Selecting **Cancel** cancels the exposure and the **Capture** view appears.

5 Select:

**Option 1:** Choose , and select a point of interest in the image.

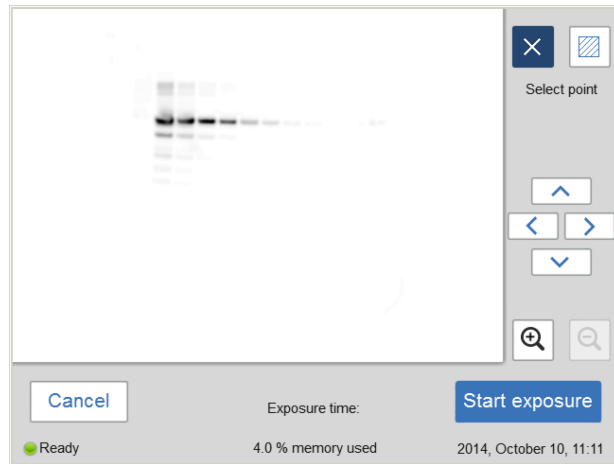

**Result:**

The selected point is highlighted with an X.

**Step**      **Action**

---



**Option 2:** Choose , and then select two diagonal corners of an area of interest in the image.

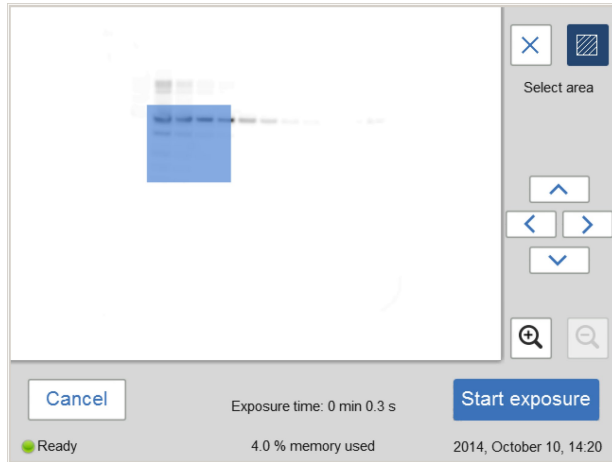

*Result:*

The selected area is highlighted with a square.

Use the right hand side arrow buttons to move the highlighted point or area.

6 Tap **Start exposure** and wait for the exposure to finish.

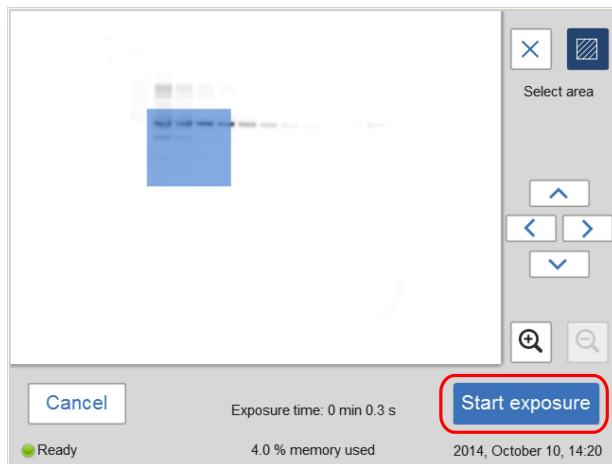

*Result:*

## 5 Operation

### 5.4 Capture an image

#### 5.4.1 Chemiluminescence capture

Step	Action
------	--------

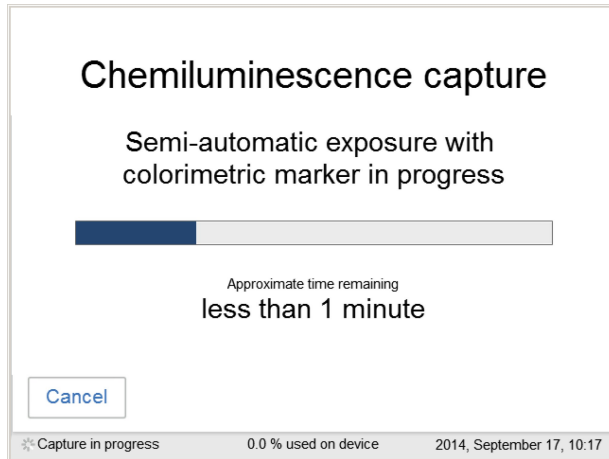

- 7 When the exposure is complete, image view appears and the images are displayed. ImageQuant 500 creates a folder containing the created image files which can be saved. For details see [File formats, on page 95](#).

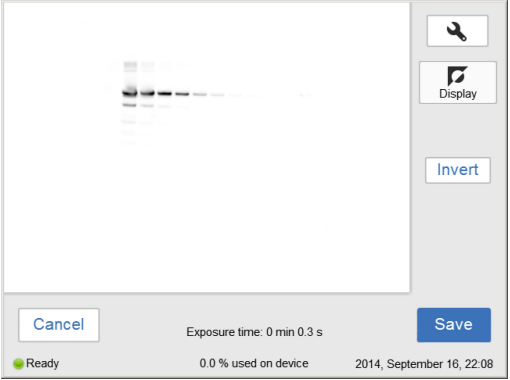
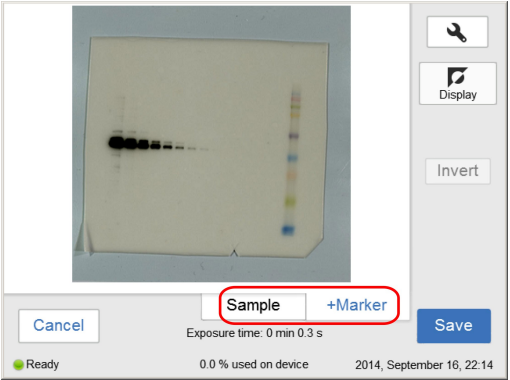

**Step Action**

If...	Then...
<p><b>No colorimetric marker was used</b></p>	<p>The resulting image is displayed in gray scale.</p> 
<p><b>Colorimetric marker was used</b></p>	<p>The resulting images are displayed under <b>Sample</b> and <b>+Marker</b> tabs.</p> <ul style="list-style-type: none"> <li>• Select the relevant tab for the image you wish to display. A selected tab is highlighted with blue text and frame.</li> <li>• Select <b>Sample</b> to see the sample without colorimetric marker.</li> <li>• Select <b>+Marker</b> to see a composite color image of the sample and colorimetric marker images.</li> </ul> 

## 5 Operation

### 5.4 Capture an image

#### 5.4.1 Chemiluminescence capture

Step	Action
8	<p>Tap the <b>Save</b> button to save the images. For other options after capturing see <a href="#">Options after image capture, on page 70</a>.</p> <p>Chemiluminescence capture with colorimetric markers generates three images: one for chemiluminescence capture, one for white light capture (colorimetric marker), and one combined color image of the chemiluminescence and white light capture.</p>

## Chemiluminescence with manual exposure

Follow the instructions below to perform chemiluminescence capture using manually set exposure time.

Step	Action
1	In the <b>Capture</b> tab, select the <b>Manual</b> radio button.

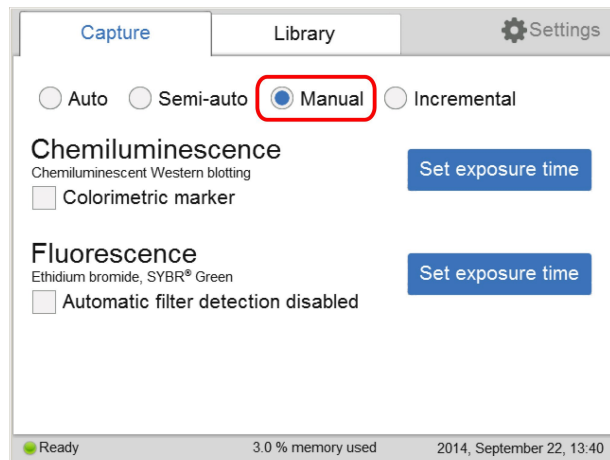

- 2 If your sample contains a colorimetric marker, then check the **Colorimetric marker** check box.

Colorimetric marker

**Step**    **Action**

3    Tap **Set exposure time** for chemiluminescence.

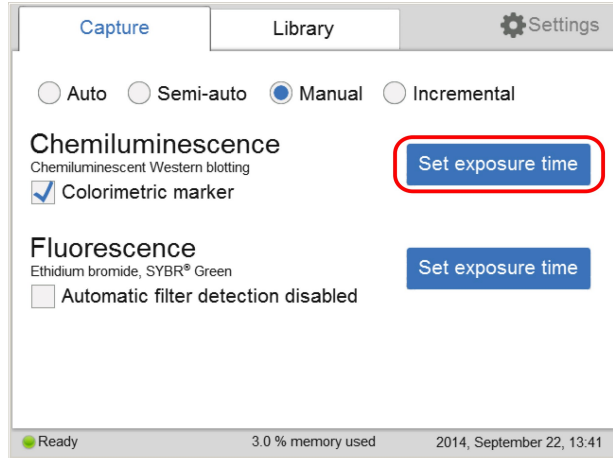

**Result:**

The **Set exposure time** view opens.

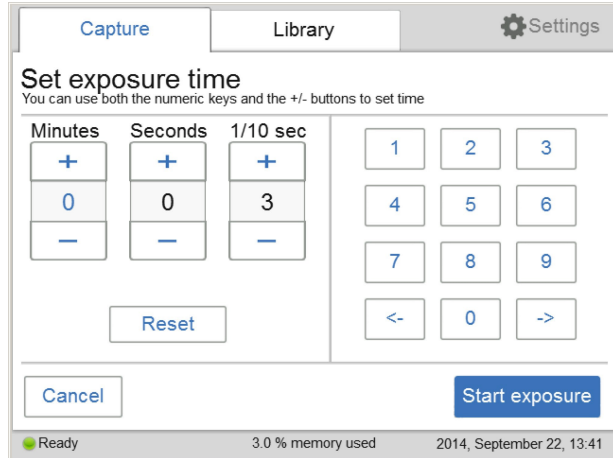

**Note:**

Selecting **Cancel** cancels the exposure and the **Capture** view appears.

4    Enter a new time.

## 5 Operation

### 5.4 Capture an image

#### 5.4.1 Chemiluminescence capture

Step	Action
------	--------

- |   |  |
|---|--|
| 5 | Tap <b>Start exposure</b> and wait for the exposure to finish. |
|---|--|

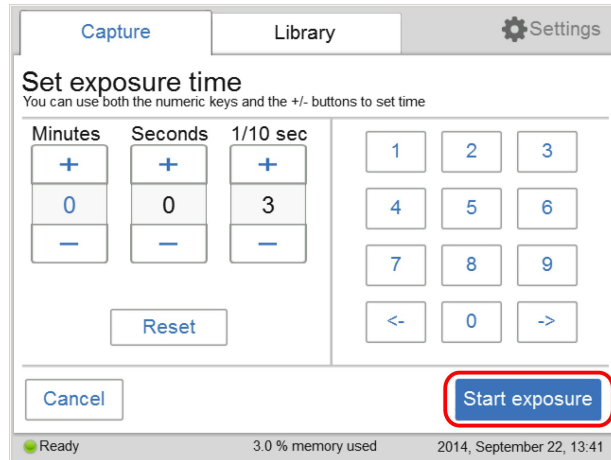

**Result:**

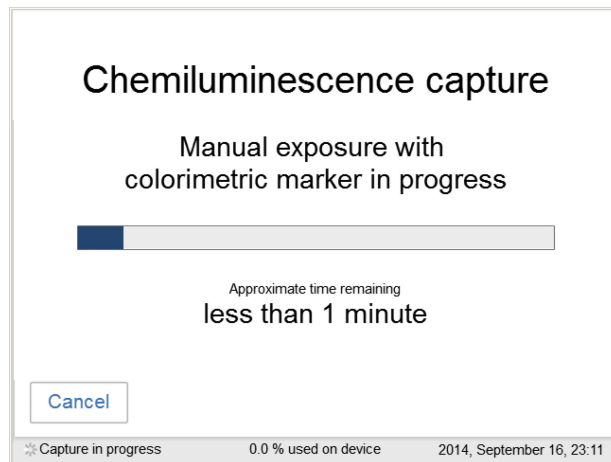

- |   |   |
|---|---|
| 6 | When the exposure is finished the image view appears displaying the image. ImageQuant 500 creates a folder containing image files that can be saved. For details see <a href="#">File formats, on page 95</a> . |
|---|---|

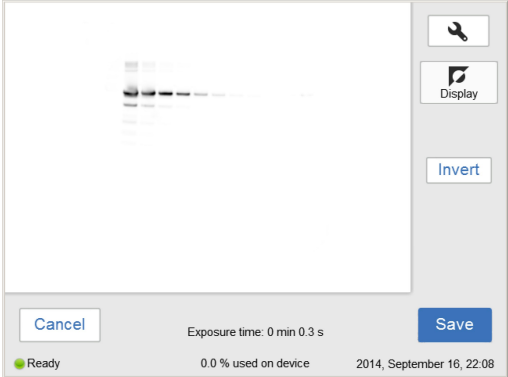
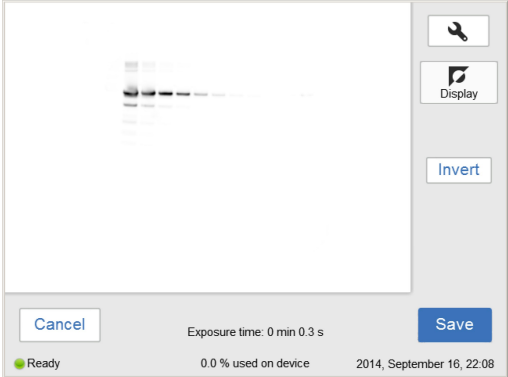
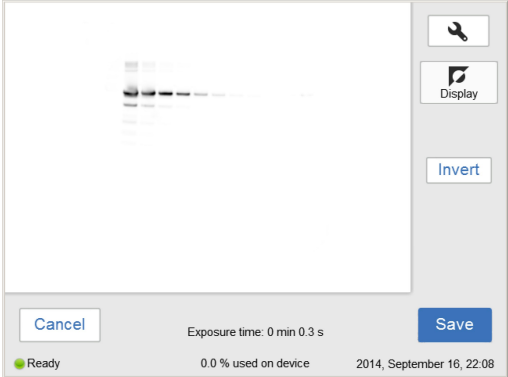
Step	Action						
	<table border="1"> <thead> <tr> <th>If...</th> <th>Then...</th> </tr> </thead> <tbody> <tr> <td> <p><b>No colorimetric marker was used</b></p> </td> <td> <p>The resulting image is displayed in gray scale.</p>  </td> </tr> <tr> <td> <p><b>Colorimetric marker was used</b></p> </td> <td> <p>The resulting images are displayed under <b>Sample</b> and <b>+Marker</b> tabs.</p> <ul style="list-style-type: none"> <li>• Select the relevant tab for the image you wish to display. A selected tab is highlighted with blue text and frame.</li> <li>• Select <b>Sample</b> to see the sample without colorimetric marker.</li> <li>• Select <b>+Marker</b> to see a composite color image of the sample and colorimetric marker images.</li> </ul>  </td> </tr> </tbody> </table>	If...	Then...	<p><b>No colorimetric marker was used</b></p>	<p>The resulting image is displayed in gray scale.</p> 	<p><b>Colorimetric marker was used</b></p>	<p>The resulting images are displayed under <b>Sample</b> and <b>+Marker</b> tabs.</p> <ul style="list-style-type: none"> <li>• Select the relevant tab for the image you wish to display. A selected tab is highlighted with blue text and frame.</li> <li>• Select <b>Sample</b> to see the sample without colorimetric marker.</li> <li>• Select <b>+Marker</b> to see a composite color image of the sample and colorimetric marker images.</li> </ul> 
If...	Then...						
<p><b>No colorimetric marker was used</b></p>	<p>The resulting image is displayed in gray scale.</p> 						
<p><b>Colorimetric marker was used</b></p>	<p>The resulting images are displayed under <b>Sample</b> and <b>+Marker</b> tabs.</p> <ul style="list-style-type: none"> <li>• Select the relevant tab for the image you wish to display. A selected tab is highlighted with blue text and frame.</li> <li>• Select <b>Sample</b> to see the sample without colorimetric marker.</li> <li>• Select <b>+Marker</b> to see a composite color image of the sample and colorimetric marker images.</li> </ul> 						

- Select the relevant tab for the image you wish to display. A selected tab is highlighted with blue text and frame.
- Select **Sample** to see the sample without colorimetric marker.
- Select **+Marker** to see a composite color image of the sample and colorimetric marker images.

## 5 Operation

### 5.4 Capture an image

#### 5.4.1 Chemiluminescence capture

Step	Action
7	<p>Tap the <b>Save</b> button to save the images. For other options after capturing see <a href="#">Options after image capture, on page 70</a>.</p> <p>Chemiluminescence capture with colorimetric markers generates three images: one for chemiluminescence capture, one for white light capture (colorimetric marker), and one combined color image of the chemiluminescence and white light capture.</p>

## Chemiluminescence with incremental exposure

Follow the instructions below to perform chemiluminescence capture using incremental exposure time.

Step	Action
1	In the <b>Capture</b> tab, tap the <b>Incremental</b> button.

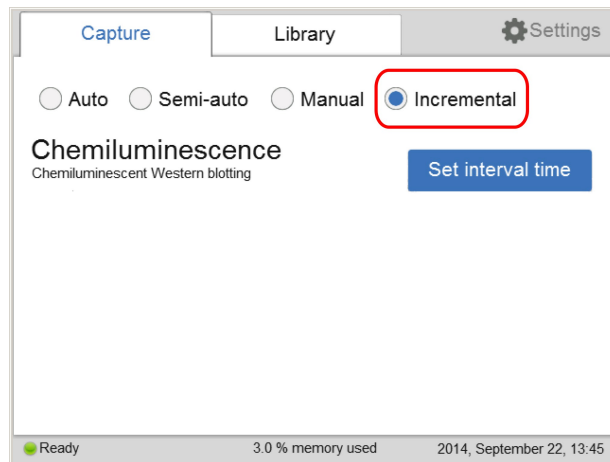

**Step**    **Action**

- 2    Tap the **Set interval time** button for chemiluminescence.

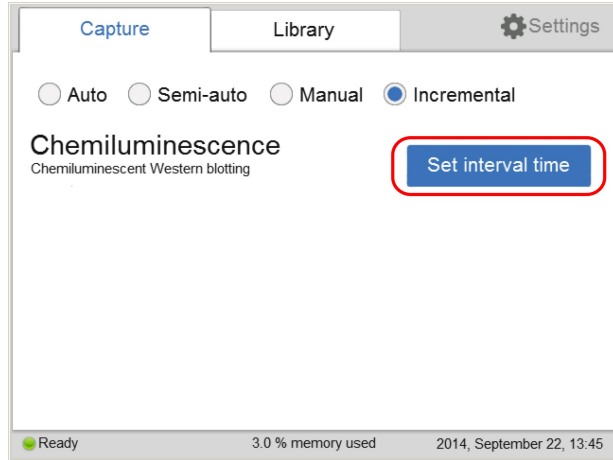

**Result:**

The **Set interval time** view opens.

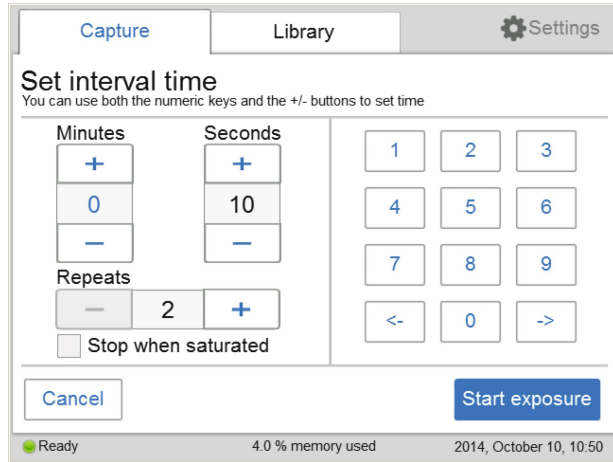

Set the number of repetitive exposures in the **Repeat** field using the plus and minus buttons.

**Repeats**



## 5 Operation

### 5.4 Capture an image

#### 5.4.1 Chemiluminescence capture

Step	Action
3	Check the <b>Stop when saturated</b> box if you wish the exposure to stop when the pixel intensity of the accumulated exposed images reaches saturation.  <b>Note:</b> <i>The <b>Stop when saturated</b> function overrides the set repetitive exposures.</i>
4	Set <b>Interval time</b> by entering a value.
5	Tap <b>Start exposure</b> and images are captured repeatedly for the set time period (or until saturated).

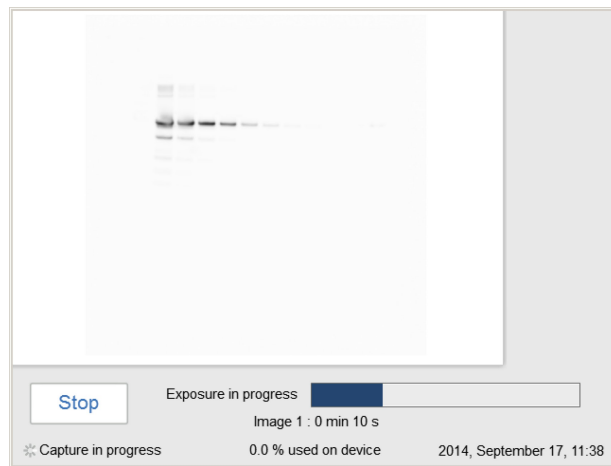

#### **Result:**

The number of images matching the selected repetitions are displayed as they are exposed. A progress bar indicates the time remaining for imaging.



- | Step | Action   |
|------|--|
| 6    | <p>When the exposure is complete, the image view displays the images. Navigate among the images by selecting the left or right arrows. Use the <b>Intensity</b> tool to check pixel intensity and the <b>Contrast</b> tool to change the contrast of the images. When more than one image is taken with the incremental exposure, the new contrast setting will be applied to all the images.</p> <p>ImageQuant 500 creates a folder containing the created image files that can be saved. For details, see <a href="#">File formats on page 95</a>.</p> |

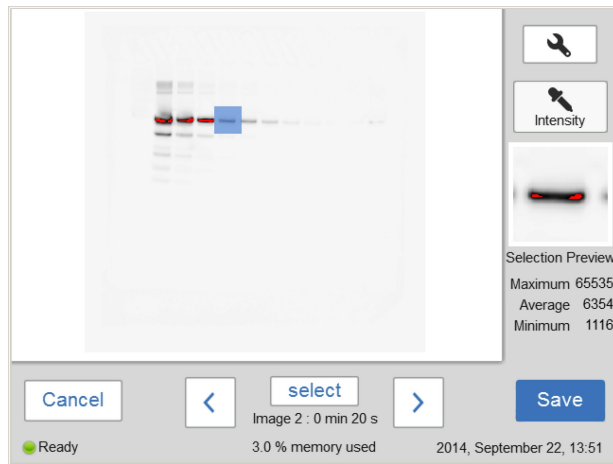

- 7 Use the **Select** button to select the images you wish to save. Then select the **Save** button.

**Note:**

*If more than one image is selected, then the **Library** view will open after saving the images.*

## 5 Operation

### 5.4 Capture an image

#### 5.4.1 Chemiluminescence capture

Step	Action
------	--------



### Options after image capture

Select one or more of the following actions after capturing:

- To save the image, select **Save**. This allows images to be reopened later with the image tools. See [Section 5.6 Save the image, on page 94](#) and [Section 5.7 File handling, on page 97](#) for further instructions.
- To modify the display settings or view details of the image, select the image tools to the right of the image. See [Image tools on page 91](#) for further instructions.
- To discard an image without saving, select **Cancel** and confirm in the following dialog.

## 5.4.2 Fluorescence capture

### Introduction

Fluorescence image capture is performed with Epi-illumination (UV and Blue).

### Fluorescence exposure options

There are three exposure options for fluorescence image capture. The table below suggests which option to use in different situations.

When...	Then...
An optimal dynamic range is required:	Select <b>Auto</b> for automatic exposure. A short pre-exposure is performed to determine the signal intensity. The system will use this information to calculate which exposure time will give the highest possible signal below saturation to enable accurate quantification of the sample.
A specific area of a sample is of interest:	Select <b>Semi-auto</b> . A short pre-exposure is performed which results in an image. This allows you to select the area of the sample image to focus on. The software automatically calculates the optimal exposure time for the specified area.
The intensity of the image is inadequate after automatic exposure or a known exposure time is required:	Select <b>Manual</b> exposure and set the exposure time manually.

### Fluorescence with automatic exposure

Follow the instructions below to perform fluorescence capture using automatic exposure time.

**Step**    **Action**

- 1    In the **Capture** tab, select the **Auto** radio button (set as default).

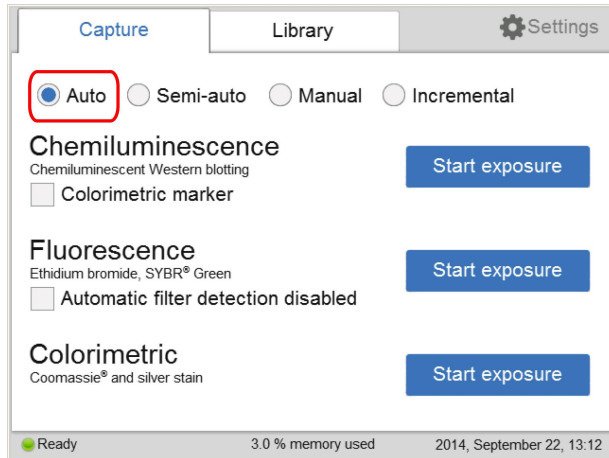

- 2    Check the **Automatic filter detection disabled** box, if the fluorescence sample is larger than the image area (10×15 cm) or if the automatic filter detection fails.

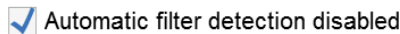

- 3    Tap the **Start exposure** button for fluorescence.

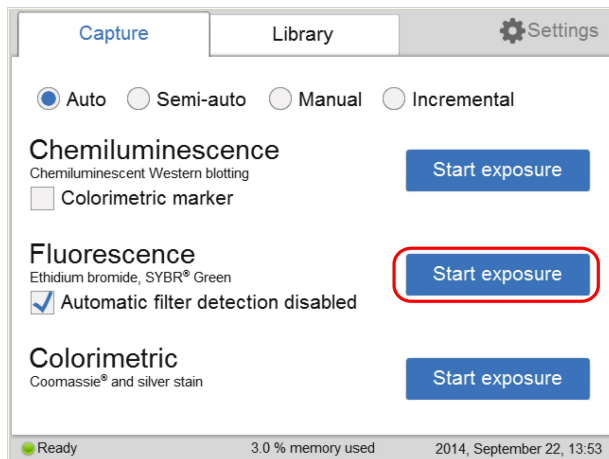

**Step**      **Action**

---

*Result:*

The exposure will begin following a pre-exposure. A progress bar appears on the screen indicating the time remaining of the imaging process, the exposure selected and the actual exposure time.

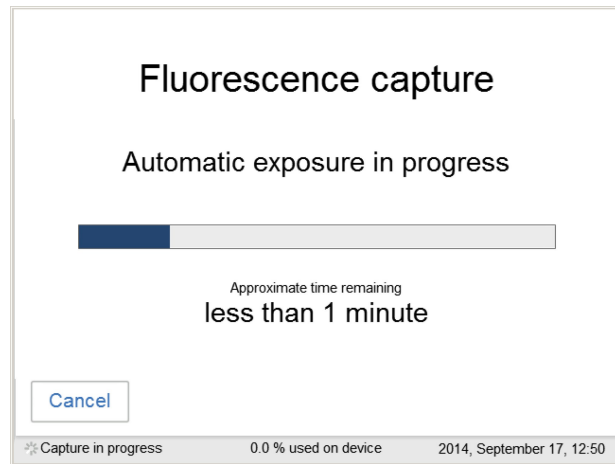

**Note:**

Selecting **Cancel** will cancel the exposure and the **Capture** view will appear.

- 4      When the exposure is complete, image view appears and the image are displayed. ImageQuant 500 creates a folder containing the image files that can be saved. For details, see [File formats on page 95](#).

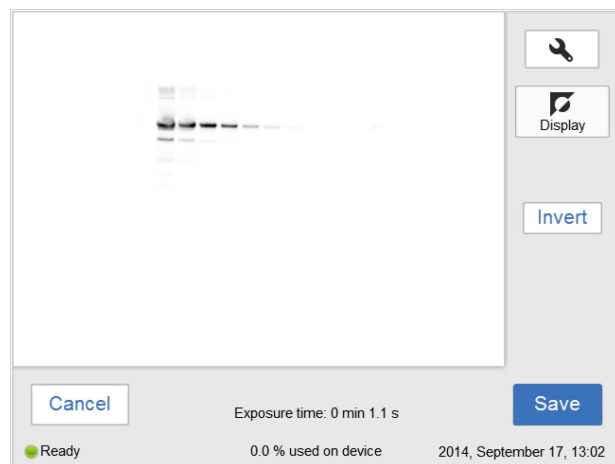

Step	Action
------	--------

*Result:*

The resulting image is displayed in gray scale.

- |   |  |
|---|--|
| 5 | Tap the <b>Save</b> button to save the images. For other options after capturing, see <a href="#">Options after image capture on page 82</a> . |
|---|--|

## Fluorescence with semi-automatic exposure

Follow the instructions below to perform fluorescence capture using semi-automatic set exposure time.

Step	Action
------	--------

- |   |  |
|---|--|
| 1 | In the <b>Capture</b> tab, select the <b>Semi-auto</b> . |
|---|--|

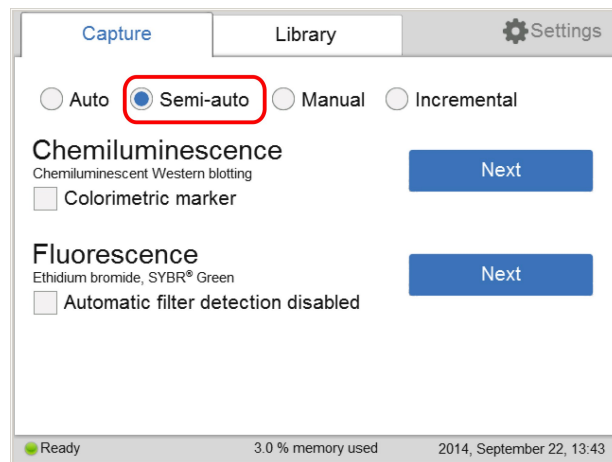

- |   |   |
|---|---|
| 2 | Check the <b>Automatic filter detection disabled</b> box, if the fluorescence sample is larger than the image area (10×15 cm) or if the automatic filter detection fails. |
|---|---|

Automatic filter detection disabled

Step	Action
3	Tap the <b>Next</b> button for fluorescence.

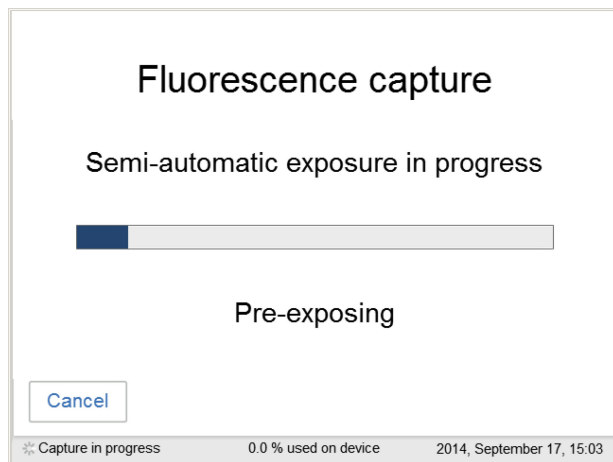
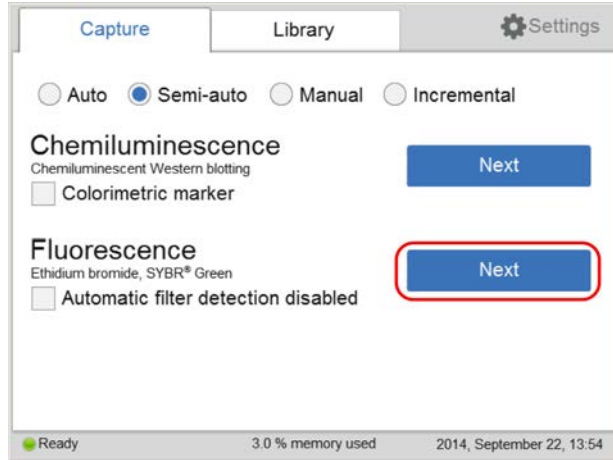

When the pre-exposure is finished, a low-resolution preview image is displayed.

**Step**      **Action**

---

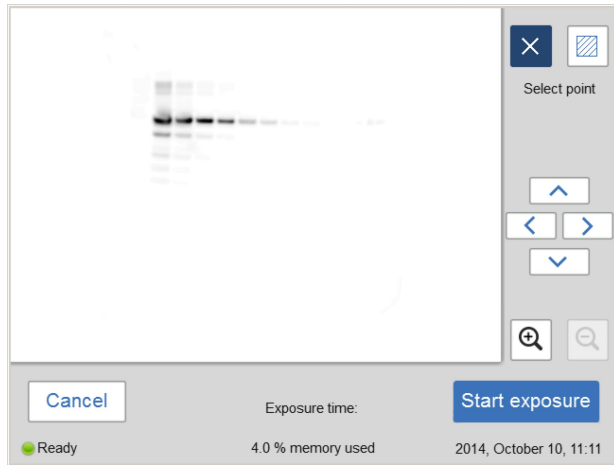

Use the zoom tools and arrows to get an optimal view of the area of interest.

Choose  to zoom in.

Choose  to zoom out.

**Note:**

Selecting **Cancel** will cancel the exposure and the **Capture** view will appear.



Step	Action
4	Choose one of the two options displayed to the right of the image to point out the area of interest:

Choose , and select a point of interest in the image.

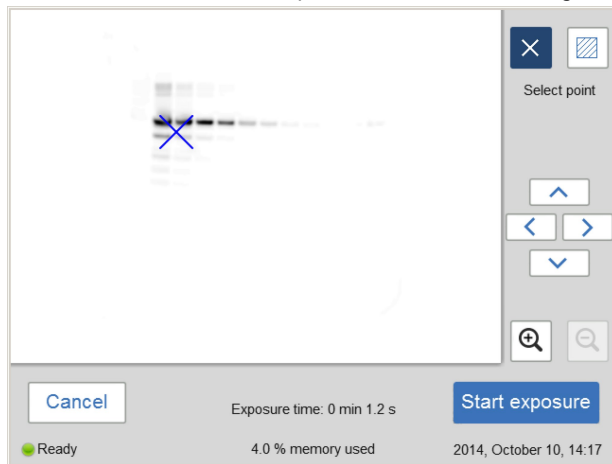

*Result:*

The selected point is highlighted with an X.

Choose , and then select two diagonal corners of an area of interest in the image.

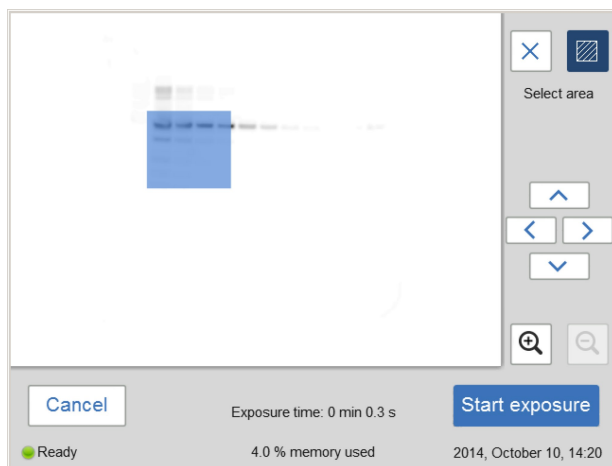

*Result:*

Step	Action
------	--------

The selected area is highlighted with a square.  
Use the right-hand side arrow buttons to move the highlighted point or area.

- 5 Tap **Start exposure** and wait for the exposure to finish.

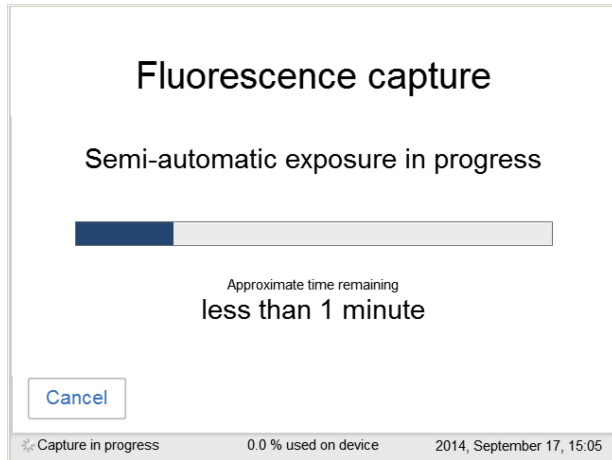
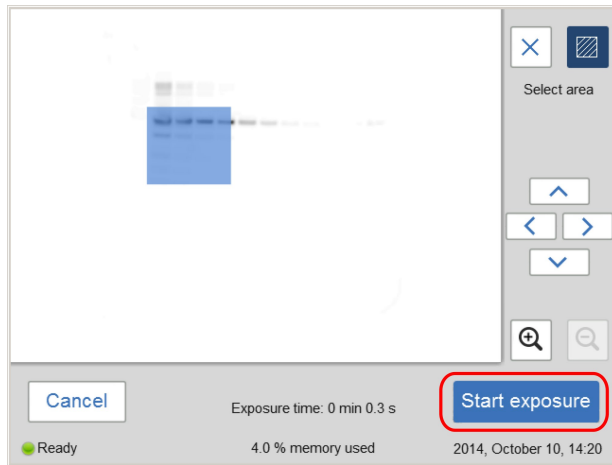

Step	Action
------	--------

- |   |   |
|---|---|
| 6 | When the exposure is complete, image view appears and the image are displayed. ImageQuant 500 creates a folder containing the image files that can be saved. For details, see <a href="#">File formats on page 95</a> . |
|---|---|

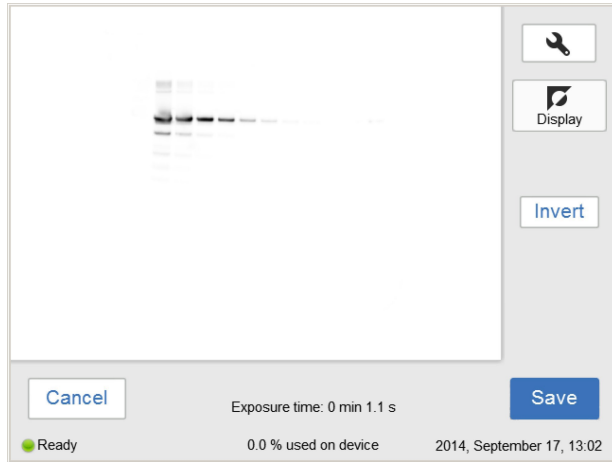

- |   |  |
|---|--|
| 7 | Tap the <b>Save</b> button to save the images. For other options after capturing, see <a href="#">Options after image capture on page 82</a> . |
|---|--|

## Fluorescence with manual exposure

Follow the instructions below to perform fluorescence capture using manually set exposure time.

## 5 Operation

### 5.4 Capture an image

#### 5.4.2 Fluorescence capture

Step	Action
------	--------

- |   |   |
|---|---|
| 1 | In the <b>Capture</b> tab, select the <b>Manual</b> radio button. |
|---|---|

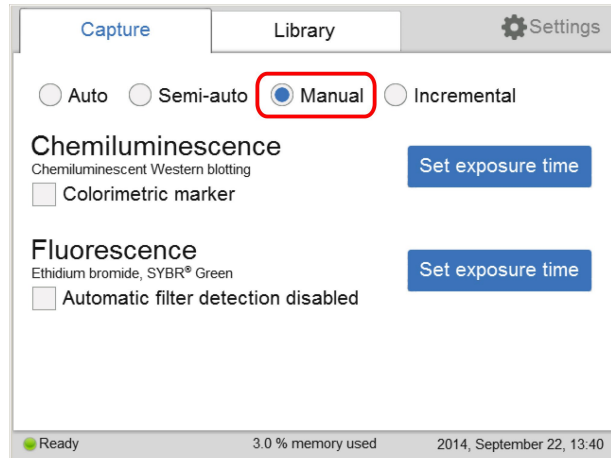

- |   |   |
|---|---|
| 2 | Check the <b>Automatic filter detection disabled</b> box, if the fluorescence sample is larger than the image area (10×15 cm) or if the automatic filter detection fails. |
|---|---|

Automatic filter detection disabled

- |   |  |
|---|--|
| 3 | Tap the <b>Set exposure time</b> for fluorescence. |
|---|--|

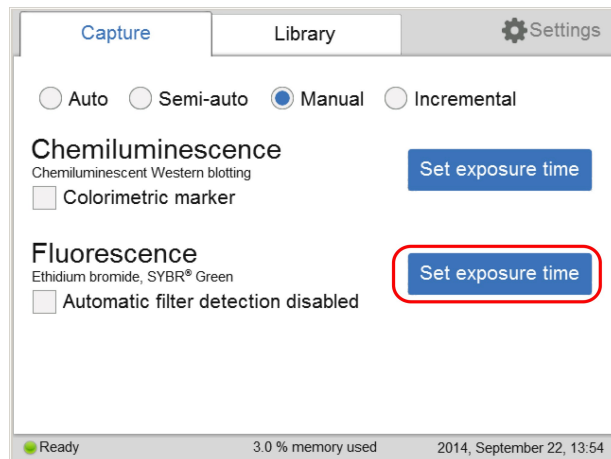

**Step**      **Action**

---

*Result:*

The **Set exposure time** view opens.

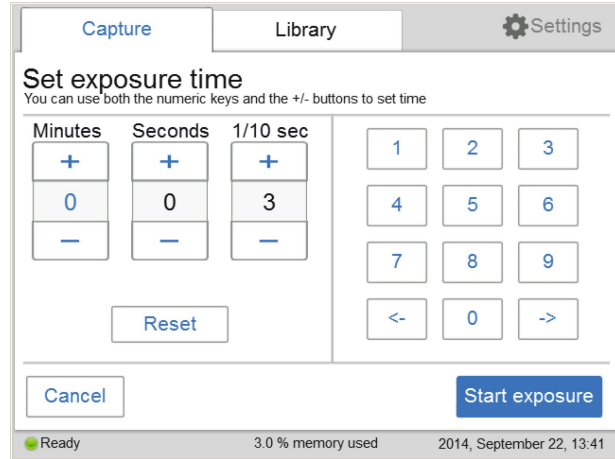

**Note:**

Selecting **Cancel** will cancel the exposure and the **Capture** view will appear.

- 4      Enter the new time.
- 5      Tap **Start exposure** and wait for the exposure to finish.

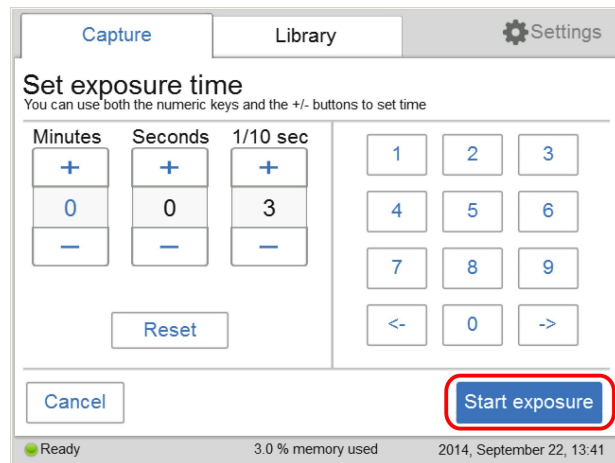

**Step**    **Action**

---

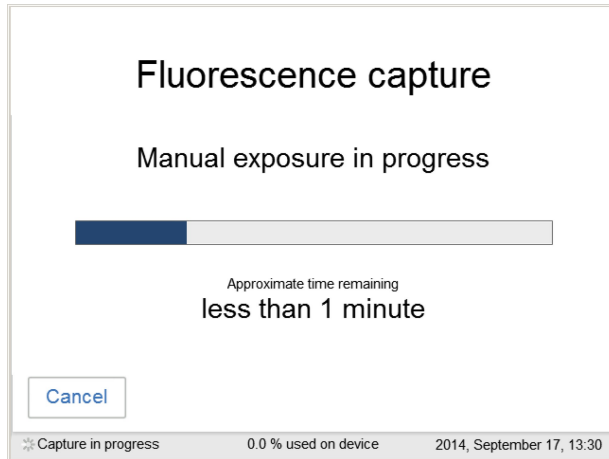

- 6 When the exposure is finished, the image view displays the image. ImageQuant 500 creates a folder containing image files that can be saved. For details, see [File formats on page 95](#).

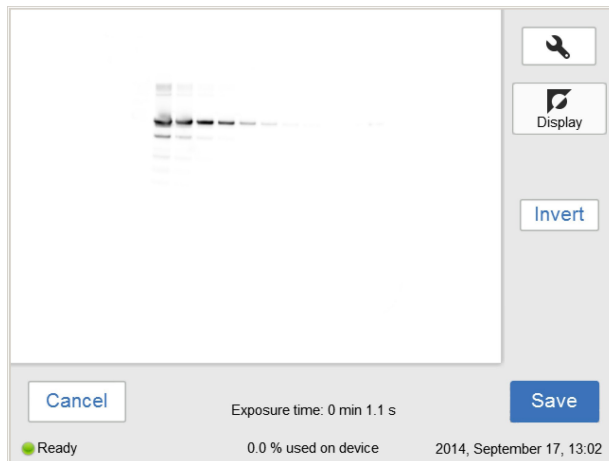

- 7 Tap the **Save** button to save the images. For other options after capturing, see [Options after image capture on page 82](#).
- 

## Options after image capture

Select one or more of the following actions after capturing:

- To save the image, select **Save**. This will allow images to be reopened later with the image tools. See [Section 5.6 Save the image, on page 94](#) and [Section 5.7 File handling, on page 97](#) for further instructions.

- To modify the display settings or view details of the image, select the image tools to the right of the image. See [Image tools on page 91](#), for further instructions.
- To discard the image without saving, select **Cancel** and confirm the following dialog.

## 5.4.3 Colorimetric capture

### Introduction

The colorimetric capture uses an epi-white illumination light source located at the top of the ImageQuant 500 interior.

The images are by default created with automatic exposure time.

### Automatic colorimetric capture

Follow the instructions below to perform colorimetric capture using automatic exposure time.

Step	Action
------	--------

- |   |  |
|---|--|
| 1 | In the <b>Capture</b> tab, select the <b>Auto</b> button (set as default). |
|---|--|

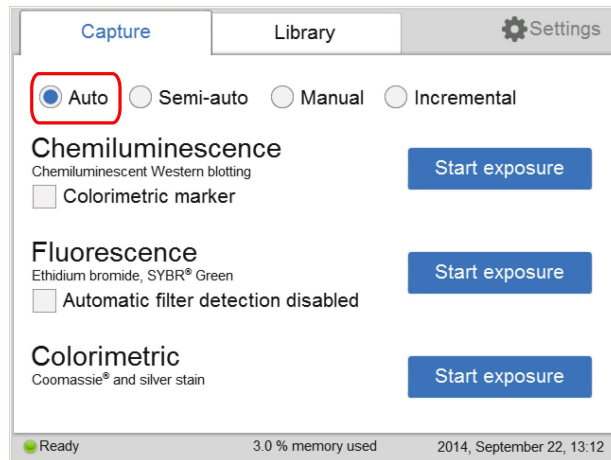



Step	Action
2	Tap the <b>Start exposure</b> for colorimetric.

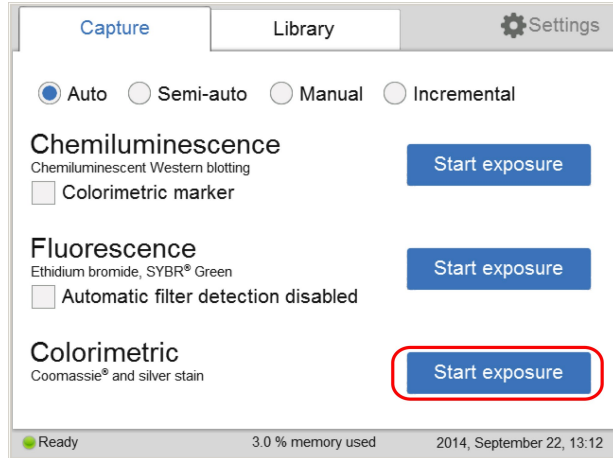

**Result:**

The exposure begins following a pre-exposure. A progress bar appears on the screen indicating the time remaining of the imaging process, the exposure selected, and the actual exposure time.

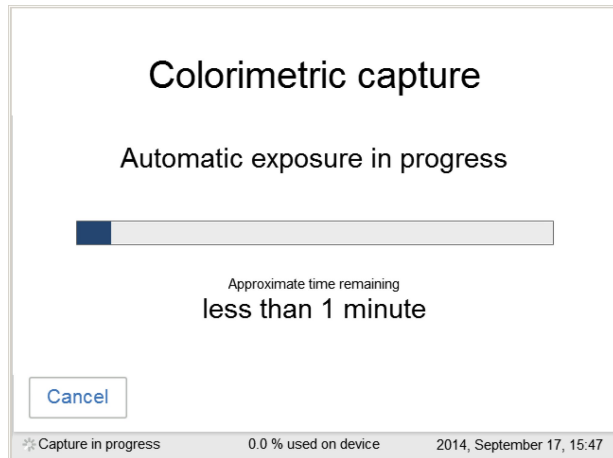

**Note:**

Selecting **Cancel** cancels the exposure and the **Capture** view appears.

## 5 Operation

### 5.4 Capture an image

#### 5.4.3 Colorimetric capture

Step	Action
------	--------

- |   |   |
|---|---|
| 3 | When the exposure is complete, image view appears and the image is displayed. ImageQuant 500 creates a folder containing the image files that can be saved. For details, see <a href="#">File formats, on page 95</a> . |
|---|---|

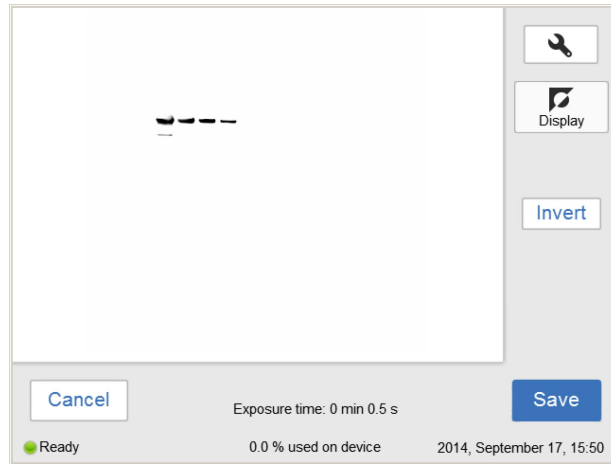

*Result:*

The resulting image is displayed in gray scale.

- |   |   |
|---|---|
| 4 | Tap the <b>Save</b> button to save the images. For other options after capturing, see <a href="#">Options after image capture, on page 86</a> . |
|---|---|

## Options after image capture

Select one or more of the following actions after capturing:





- To save the image select **Save**. This will allow images to be reopened later with the image tools. See [Save window, on page 94](#) and [Section 5.7 File handling, on page 97](#) for further instructions.
- To modify the display settings or view details of the image, select the image tools to the right of the image. See [Image tools, on page 91](#) for further instructions.
- To discard the image without saving select **Cancel** and confirm the following dialog.

## 5.4.4 Set the exposure and interval time

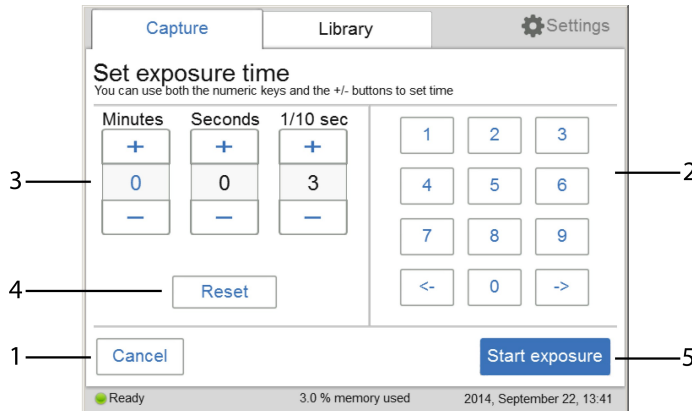
The following information describes the components and function of the **Set exposure time** and **Set interval time** windows.

### Set exposure time



Part	Function
1	Tap <b>Cancel</b> to leave the <b>Set exposure time</b> screen and return to the <b>Capture</b> tab.
2	Use the  and  button to move between the <b>Minutes</b> , <b>Seconds</b> , and <b>1/10 sec</b> fields. Tap the numeric keys to set the time in the selected field.
3	Tap <b>Minutes</b> , <b>Seconds</b> , or <b>1/10 sec</b> to select the unit of time to change. Increase or decrease the exposure time by tapping  or  .
4	Tap <b>Reset</b> to set the exposure time to zero.
5	Tap <b>Start exposure</b> to start image capture.





## 5 Operation

### 5.4 Capture an image

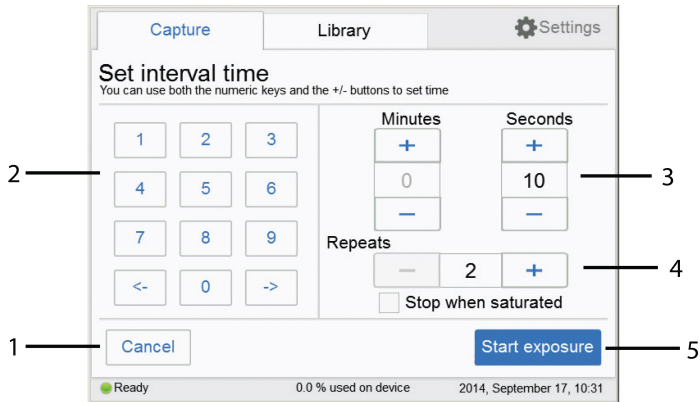
#### 5.4.4 Set the exposure and interval time

## Set interval time



Part	Function
1	Tap <b>Cancel</b> to leave the <b>Set interval time</b> screen and return to the <b>Capture</b> tab.
2	Use the  and  button to move between the <b>Minutes</b> , <b>Seconds</b> , and <b>1/10 sec</b> fields. Tap the numeric keys to set the time in the selected field.
3	Tap <b>Minutes</b> , <b>Seconds</b> , or <b>1/10 sec</b> to select the unit of time to change. Increase or decrease the exposure time by tapping  or  .
4	Tap <b>Reset</b> to set the exposure time to zero.
5	Tap <b>Start exposure</b> to start image capture.

## 5.5 View the images

### Introduction

When the image capture is complete, the images are displayed on the screen. The content shown varies with the capture methods and exposure options.

The following illustration and table describe the image result view.

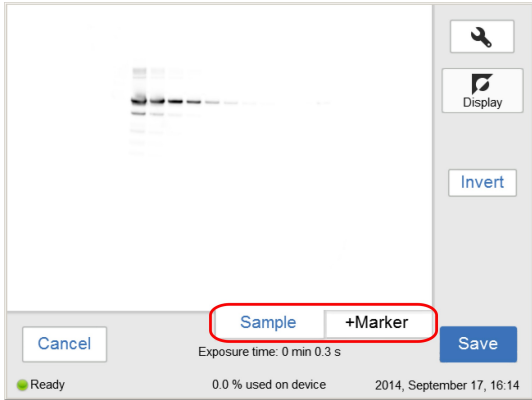
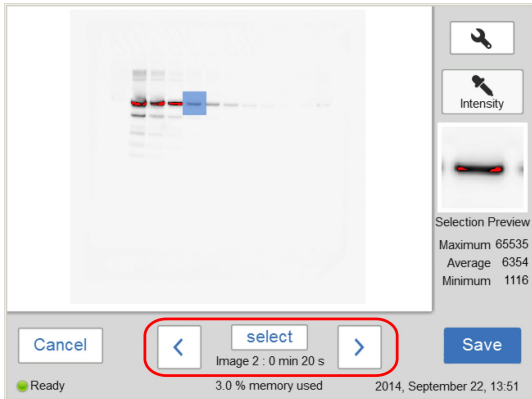

Part	Function
1	Leaves the image view screen without saving the image.

Part	Function
2	<p>Display of the captured image.</p> <p><b>Note:</b>  <i>For chemiluminescence capture with colorimetric markers, the image from the chemiluminescence capture is viewed in the <b>Sample</b> tab, and the chemiluminescence capture and colorimetric marker combined image is viewed in <b>+Marker</b> tab in the image view.</i></p>  <p>Incremental exposure displays a series of images one at a time as they are exposed. Navigate among the images using forward and backward arrows.</p> 
3	<p>Displays the Images tools menu. For detailed information about the <b>Images tools</b> menu, go to the <b>Tools</b> menu, see <a href="#">Image tools on page 91</a>.</p>
4	<p>Shows which image tool is selected. In this example the <b>Display</b> tool is selected.</p>

Part	Function
5	Shows which factor(s) of an image can be visually modified. In this example, the <b>Invert</b> button under the <b>Display</b> tool is shown.
6	Saves the displayed image. For detailed information about how to save an image, see <a href="#">Section 5.6 Save the image, on page 94</a> .

## Image tools

An image can be visually modified and examined with the **Image tools** found on right of the screen. The tools can be used immediately after image capture and on previously saved images. One or several of the tools can be used to modify or to examine the images.

**Note:** *The original image data remains unaltered.*

The tools can be accessed by tapping on the tool button, .

The following image and table shows and describes the components of the tools menu.

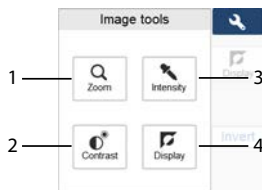



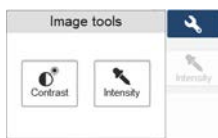

Only **Contrast** and **Intensity** tools are available when taking images of samples in Incremental mode.



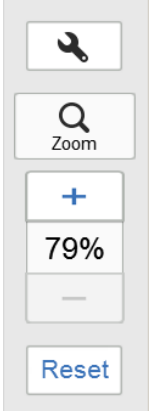

Part	Function
1	<b>Zoom</b> button: tap on this button to select the zoom tool.
2	<b>Contrast</b> button: tap on this button to select the contrast tool.
3	<b>Intensity</b> button: tap on this button to select the intensity tool.
4	<b>Display</b> button: tap on this button to select the display tool.

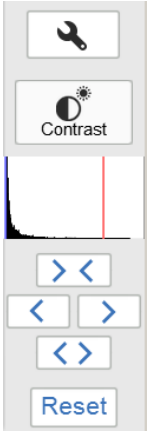
The following table describes each tool in the image tools menu in detail.

Description	Illustration
<p>Open the <b>Zoom</b> tool by selecting the zoom button in the image tools menu.</p> <p>Use the plus or minus buttons to zoom in or out in the image.</p> <p>When zooming in, arrows appear in the image view. Use the arrows, or point to the image and drag, to position the image on the screen. If a different tool is selected when the image is zoomed in, the selected zoom will be kept until saved.</p>  <p>Use the <b>Reset</b> button to return to the original zoom view.</p> <p><b>Note:</b> The <b>Zoom</b> tool is not available for incremental imaging.</p>	
<p>The contrast tool is opened by tapping on the <b>Contrast</b> button in the <b>Image tools</b> menu.</p> <p>Use the  and  buttons to change the brightness of the image.</p> <p>Use the  and  buttons to change the contrast of the image.</p> <p>For samples with colorimetric marker the contrast tool can be used for setting the contrast of the chemiluminescent sample in the combined color image. The chosen contrast is saved with the combined color image.</p> <p><b>Image histogram</b></p> <p>The histogram shows the intensity distribution by plotting the number of pixels for each intensity value in the image. The horizontal axis represents variation of intensity. The vertical axis represents the number of pixels at a given intensity.</p> <p>The blue and red lines indicate the min/max range of the gray scale in the displayed image.</p>	



Description	Illustration
<p>Open the <b>Intensity</b> tool by selecting the intensity button in the image tools menu.</p> <p>Select an area of interest in the image. The selected area will be displayed to the right of the image. The maximum, average, and minimum intensities in the area of interest are displayed under the image.</p>  <p><b>Note:</b> <i>For incremental images, navigate between the images using the forward and backward arrows. Point to a specific area of interest to display the maximum pixel intensity and the average pixel intensity in the area.</i></p> <p><b>Tip:</b> <i>If the intensity is too low or too high, consider capturing the image with a different exposure time. High intensity results in saturation and prevents quantitative analysis. Saturation occurs close to 65 500 intensity levels.</i></p>	
<p>The <b>Display</b> tool is displayed by default after capturing or opening an image.</p> <p>The <b>Invert</b> button inverts the displayed image, that is, it changes a white background with black bands to a black background with white bands.</p> <p><b>Note:</b> <i>The <b>Display</b> tool is not available for incremental imaging.</i></p>	

## 5.6 Save the image

### Save window

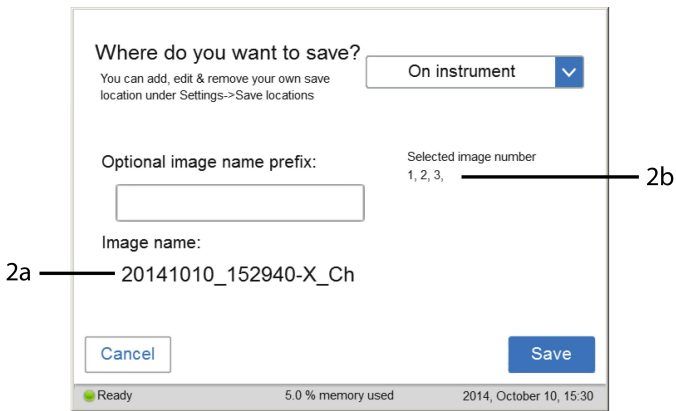
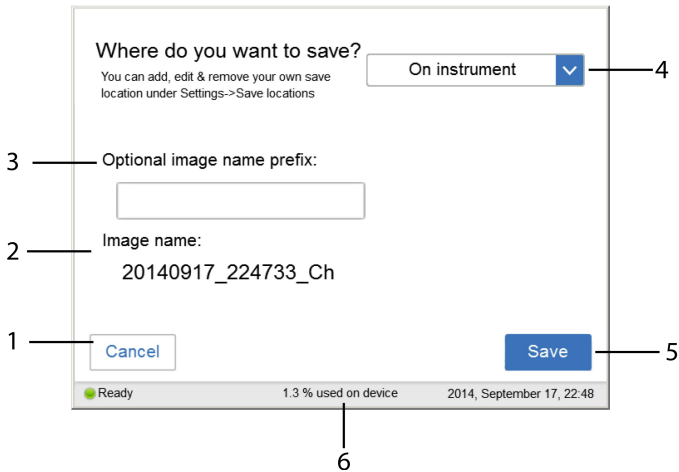

Part	Function
1	<b>Cancel</b> button: Tap on this button to return to the result window without saving.

Part	Function
2	<p><b>Image name</b> field: Area where the automatically created name for the file is displayed.</p> <p><b>Note:</b> <i>The automatic name consists of the date, followed by the time of the reading and the method used indicated by Ch (Chemiluminescence), Co (Colorimetric), or Fl (Fluorescence).</i></p> <p>If several images are selected in Incremental mode, the number of the selected image is shown in X (2a) and the number of selected images is displayed in 2b.</p>
3	<p><b>Optional image name prefix</b> field: Used to enter an optional personalized image name prefix.</p> <p>Tap on the <b>Optional image name prefix</b> field and use the keypad to add a prefix to the image file name. For more information on how to use the keypad, go to <a href="#">Keypad on page 102</a>.</p> <p><b>Note:</b> <i>The prefix will be added to the beginning of the file name.</i></p>
4	<p><b>Where do you want to save?</b> field: Tap on the drop down menu to choose where to save the file.</p> <p><b>Note:</b> <i>Image(s) can be saved on the device. However, it is recommended to use a USB flash drive or a network.</i></p>
5	<p><b>Save</b> button: Tap on this button to save the file.</p>
6	<p>Number of files stored on the device, as percentage of used device memory.</p>

**Note:** *It is also possible to add a network save location, for more information on how to add a save location, go to [Add a new save location on page 107](#).*

## Memory handling

The ImageQuant 500 is equipped with a flash drive that allows for storage of a finite number of images on the instrument. It is recommended that you regularly remove images from the instrument to maintain available storage space. If the instrument flash drive runs full, the oldest images will be removed automatically when a new image is captured.

## File formats

The image files are stored in the formats described in the table below.

## 5 Operation

### 5.6 Save the image

Imaging method	File format of saved image
Chemiluminescence	16-bit tif image
Chemiluminescence with colorimetric marker	Folder containing the following files: <ul style="list-style-type: none"><li>• 16-bit tif image of the chemiluminescent sample</li><li>• 16-bit tif image of the colorimetric marker</li><li>• jpg combined color image of the chemiluminescent sample and the colorimetric marker</li></ul>
Fluorescence	16-bit tif
Colorimetric	16-bit tif

**Tip:** *The combined jpg image with chemiluminescent sample and colorimetric marker can be used for approximate molecular weight determination. The individual tif images (sample image and marker image) can be used for accurate molecular weight calibration using appropriate analysis software, such as ImageQuant TL.*

## 5.7 File handling

### Introduction

In the **Library** tab, image files can be deleted, copied, moved, renamed, or opened. The files can be sorted by method, name, and date. The order of the file list can be inverted. If the ImageQuant 500 is connected to a network, there is a possibility to use the **ImageQuant 500 web tool** to copy and/or delete files from the system.

### Library tab layout

The image and table below shows and describes the components of the **Library** tab.

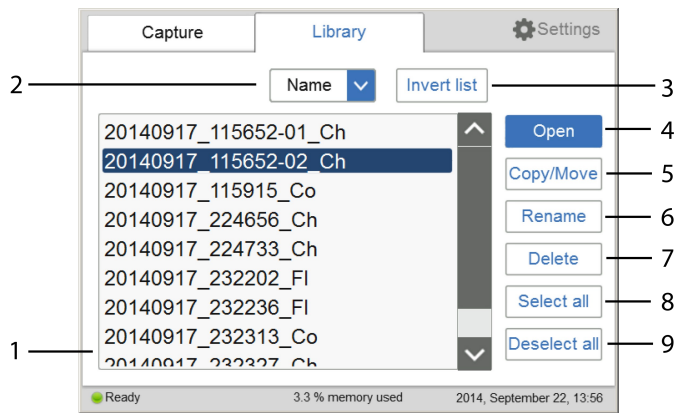

Part	Function
1	List of the stored files
2	Drop down menu to change the parameter that the files are sorted after. The files can be sorted by: <ul style="list-style-type: none"> <li>• Name</li> <li>• Date</li> <li>• Method</li> </ul>
3	<b>Invert list</b> button: tap on this button to invert the list.
4	<b>Open</b> button: tap on this button to open a file.
5	<b>Copy/Move</b> button: tap on this button to copy or move files.
6	<b>Rename</b> button: tap on this button to rename files.
7	<b>Delete</b> button: tap on this button to delete files.
8	<b>Select all</b> button: tap on this button to select all files.

Part	Function
9	<b>Deselect all</b> button: tap on this button to deselect all files.

## Description of *Library* functions

### Select and deselect all

The **Select all** and **Deselect all** buttons are used to select or deselect all of the files in the library.

### Delete files

To delete files from the device:

Step	Action
------	--------

1	Tap <b>Delete</b> .
---	---------------------

*Result:*

The following window opens:

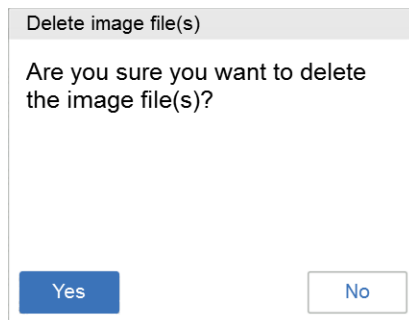

2	Tap <b>Yes</b> to delete the files.
---	-------------------------------------

### Copy or move files

To copy or move files:

Step	Action
------	--------

1	Tap on <b>Copy/Move</b> .
---	---------------------------

Step	Action
------	--------

*Result:*

The following window opens:

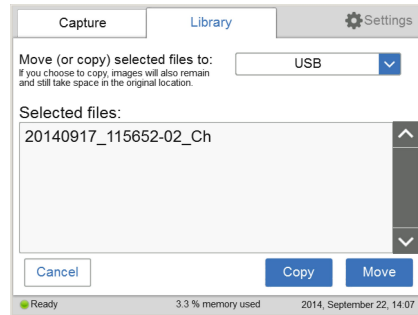

- 2 Select the location to copy or move the files in the **Move (or copy) selected files to:** drop down menu.
- 3 Tap **Copy** to copy files to the desired location.  
Tap **Move** to move files to the desired location.

**Note:**

*When a file is copied the file also remains in the original location.*

## Rename files

Follow the steps below to rename files.

Step	Action
------	--------

- 1 Select the files to rename by tapping them.
- 2 Tap on the **Rename** button.  
*Result:*  
The keypad appears.
- 3 Use the keypad to change the name of the file. Tap on **Done** to save the changes.

## Open files

Follow the steps below to open files.

Step	Action
------	--------

- 1 Tap the file to be opened.

Step	Action
2	Tap <b>Open</b> to open the file.
3	If desired, use the <b>Image tools</b> to adjust the view of the image. For detailed information about <b>Image tools</b> , go to <a href="#">Image tools, on page 91</a> .  <b>Note:</b> <i>When using the Image tools to adjust an image opened from the <b>Library</b> tab, the adjustments cannot be saved.</i>
4	When finished, tap <b>Ok</b> to return to the <b>Library</b> tab.

## ImageQuant 500 web tool

### Introduction

The **ImageQuant 500 web tool** can be used to copy or delete files on the ImageQuant 500 at a remote location.

### Prerequisites

To be able to access **ImageQuant 500 web tool** the following conditions must be fulfilled:

- The ImageQuant 500 and the computer must be connected through a local network.
- The system IP address must be known.

The system's IP address is found in the **Network** window. Access the **Network** window by tapping the **Settings** icon in the start screen and then tapping the **Network** button in the **Settings** window.

**Note:** *DHCP networks has a dynamic IP address assignment, meaning that the IP address may vary between times of connection. When using a DHCP network connection check from time to time that the IP address is still accurate. If the IP address has changed, use the new IP address.*

### Access web tool

Follow the steps below to set up and access web tool.

Step	Action
1	Open a web browser of choice on the computer.
2	Type in the system's IP address in the browser address field and press enter.



Step	Action
------	--------

*Result:*

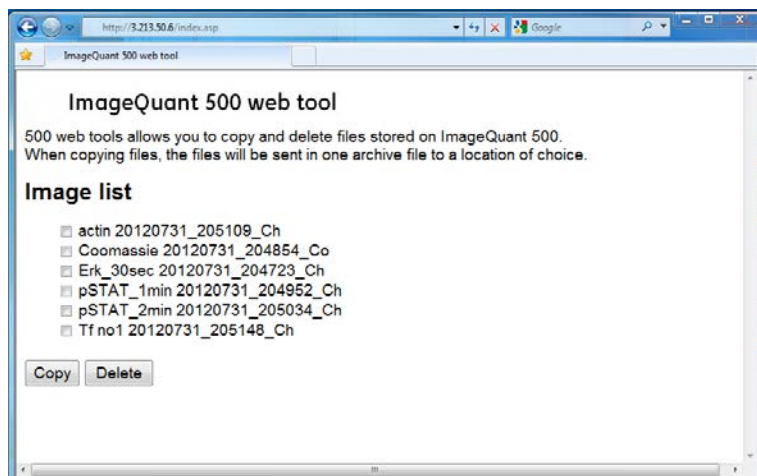

**Note:**

*Depending on the network environment, a reboot of the system may be required for **ImageQuant 500 web tool** to be available. If the web page does not appear after restart, contact your local network administrator.*

- 3 Select the files to be copied or deleted by clicking in the file's check box.

**Note:**

*The maximum number of files that can be copied at one time is 20. If there are more files to be copied, repeat the procedure.*

- 4 Tap **Delete** to delete the files.

Tap **Copy** to copy the files.

**Note:**

*The copied files are downloaded in a zip-file with a name that is automatically generated. The download location and procedure will vary with the chosen web browser's download settings.*

## 5.8 Software keypad

### Keypad

The keypad appears when the user taps on text fields to enter for example save location name or prefix, or to rename a file.

The following illustration and table shows the main components of the keypad. The image to the left shows the alphabetic view of the keypad (with lower case letters) and the image to the right shows the numeric and symbol view of the keypad.

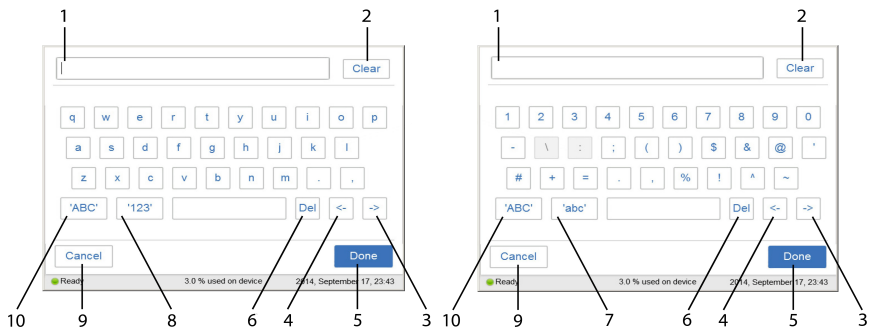

Part	Description	Function
1	Text field	Where the written text is entered.
2	<b>Clear</b> button	Removes all written text in the text field.
3	→ button	Moves forwards in the text.
4	← button	Moves backwards in the text.
5	<b>Done</b> button	Saves the changes.
6	<b>Del</b> button	Deletes one letter at a time.
7	<b>'abc'</b> button	Changes to the lowercase keypad.
8	<b>'123'</b> button	Changes to the numeric and symbol keypad.  <b>Note:</b> <i>Tap on the <b>'abc'</b> or the <b>'ABC'</b> button to return to the alphabetic keypad.</i>
9	<b>Cancel</b> button	Returns to previous window without saving the changes.
10	<b>'ABC'</b> button	Changes to the uppercase keypad.

## 5.9 Shutdown

### **Shut down the ImageQuant 500 system**

To optimize instrument lifetime and to minimize unnecessary power consumption, shut down the instrument when image captures and analyses have been completed for the day. If the ImageQuant 500 instrument is used around the clock, restart the system at least once a day to remove temporary files that may take up unnecessary memory space.

To switch off the instrument, push the power switch to the **0** position.

# 6 System settings

## About this chapter

This chapter contains information on the ImageQuant 500 software function, interface and settings.

## In this chapter

Section		See page
6.1	Introduction to the <b>Settings</b> window	105
6.2	<b>Save location</b>	107
6.3	Date and time	110
6.4	Network	111
6.5	Maintenance	112

## 6.1 Introduction to the **Settings** window

### Description

From the **Settings** window, the settings for save location, date and time, network and maintenance can be set.

### Opening settings window

The following instruction provides the necessary information to open the settings window. In the **Capture** window tap on the **Settings** icon.

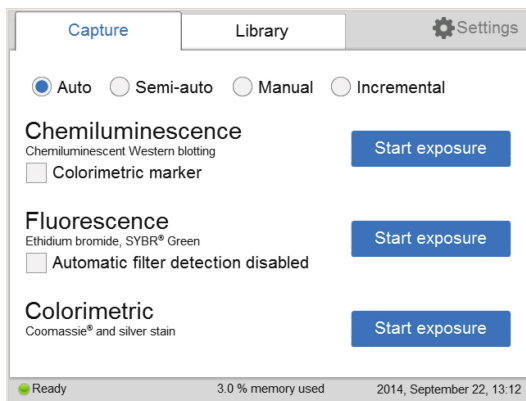

### Settings window

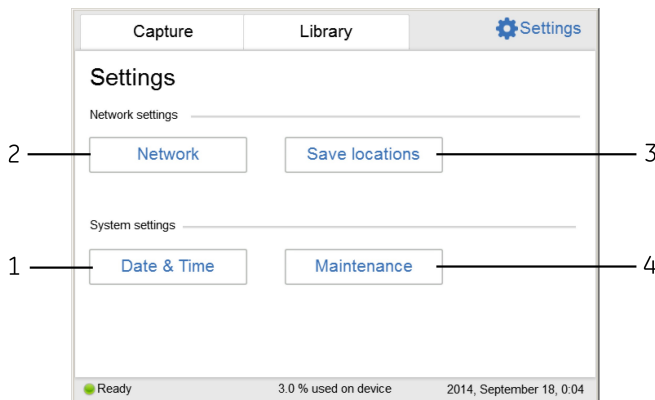

Part	Description	Function
1	<b>Date &amp; Time</b> button	Changes the date and/or time.
2	<b>Network</b> button	Changes the network settings.

## 6 System settings

### 6.1 Introduction to the **Settings** window

Part	Description	Function
3	<b>Save locations</b> button	Adds, removes, or edits locations and saves images.
4	<b>Maintenance</b> button	Updates software or exports a log file.

## 6.2 Save location

### Add a new save location

Follow the steps below to add a save location.

**Note:** To enable access to a save location over the network, the folder needs to be shared and read/write privileges must be added for ImageQuant 500.

Step	Action
------	--------

- |   |  |
|---|--|
| 1 | Tap on <b>Save locations</b> to open the <b>Save locations</b> window. |
|---|--|

*Result:*

The following window appears:

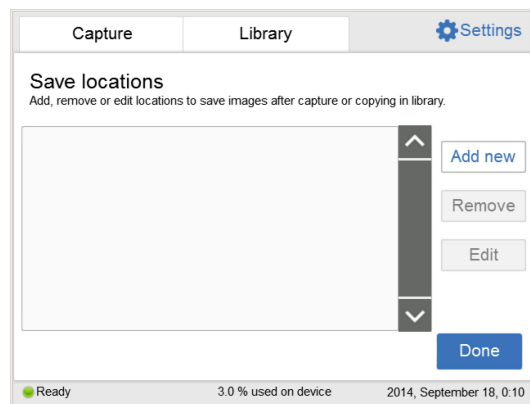

- |   |   |
|---|---|
| 2 | Tap <b>Add new</b> in the <b>Save locations</b> window. |
|---|---|

*Result:*

The following window appears:

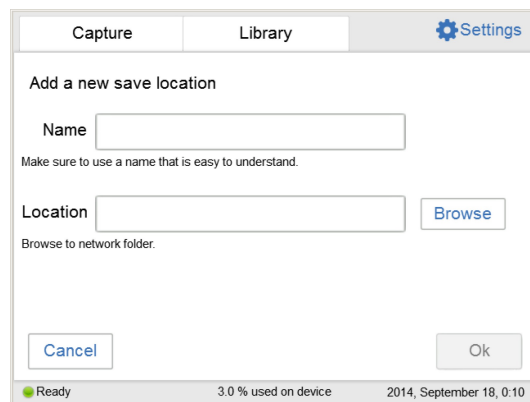

<b>Step</b>	<b>Action</b>
3	Tap <b>Name</b> and use the keypad to enter the desired name for the save location. For detailed information on how to use the keypad, go to <a href="#">Keypad on page 102</a> .
4	Tap <b>Location</b> and use the keypad to enter the network location directly and go to the Step 6 below, or tap <b>Browse</b> next to <b>Location</b> .  <b>Note:</b> <i>The network settings need to be properly configured before a network folder can be added as a save location. For information on how to configure a network, go to <a href="#">Section 4.4 Connection to network or USB flash drive, on page 38</a>.</i>
5	Choose a save location from the list and tap on <b>Use this location</b> .
6	Tap <b>Ok</b> to save the location.

## Remove save location

Follow the steps below to remove a save location.

<b>Step</b>	<b>Action</b>
1	Tap on <b>Save locations</b> to open the <b>Save locations</b> window.
2	Tap on the location that is to be removed.
3	Tap on the <b>Remove</b> button.
4	Tap <b>Yes</b> to remove the location.

## Edit save location

Follow the steps below to edit a save location.

<b>Step</b>	<b>Action</b>
1	Tap on <b>Save locations</b> to open the <b>Save locations</b> window.
2	Tap on <b>Edit</b> .
3	If desired, edit the name for the save location in the <b>Name:</b> field.



<b>Step</b>	<b>Action</b>
4	If desired, edit the folder for the save location by tapping <b>Browse</b> next to the <b>Location</b> field.  <b>Note:</b> <i>The network settings need to be properly configured before a network folder can be added as a save location. For information on how to configure a network, go to <a href="#">Section 4.4 Connection to network or USB flash drive, on page 38</a>.</i>
5	Tap <b>Ok</b> to save the changes.

## 6.3 Date and time

### **Date & time window**

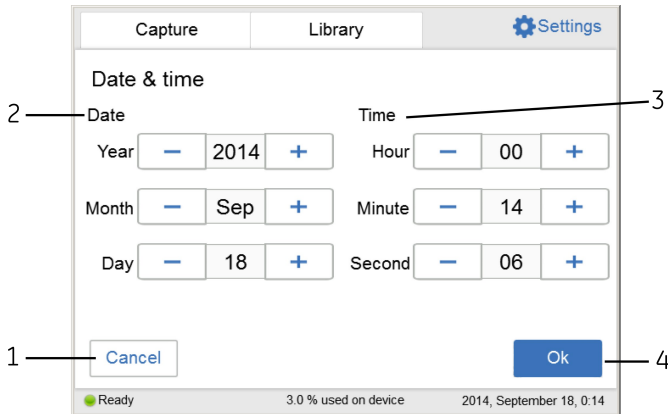

Part	Description	Function
1	<b>Cancel</b> button	Returns to the <b>Settings</b> window without saving the changes.
2	<b>Date</b> field	Sets year, month, and day.
3	<b>Time</b> field	Sets hour, minute, and second.
4	<b>Ok</b> button	Saves the changes to date and time and returns to the <b>Settings</b> window.

### **Change date**

Tap in the **Year**, **Month**, or **Day** field, and use the  and the  buttons to change the value of the selected field.

### **Change time**

Tap in the **Hour**, **Minute**, or **Second** field, and use the  and the  buttons to change the value of the selected field.

### **Save the changes to Date & time**

Tap on the **Ok** button to save the changes to the **Date & time**.

Tap on the **Cancel** button to leave the **Date & time** window without saving the changes.

## 6.4 Network

### DHCP Network

For a DHCP Network the IP address will be automatically set by the DHCP server. For detailed instructions on how to connect to a DHCP network, go to [Connect to a DHCP network on page 39](#). Tap on the **Network** button in the **Settings** window, to see the settings for the IP address, subnet mask, router, and the workgroup for the DHCP network.

### Change the name of a workgroup

Follow the steps below to change the name of a workgroup.

Step	Action
1	Tap in the <b>Workgroup</b> field to change the name of the workgroup. <i>Result:</i> A window with a keypad and a space to enter the name will appear.
2	Use the keypad to enter the desired name.
3	Tap on <b>Done</b> to save the workgroup name and return to the <b>Network</b> window.
4	Tap on <b>Save</b> to save the changes.

### Static IP

For static IP the network details are entered manually. For detailed instructions on how to connect to a Static IP network, go to [Connect to a Static IP network on page 40](#). Tap on the **Network** button in the **Settings** window to see the settings for the IP address, subnet mask, router (optional), and the workgroup for the Static IP network.

### Changes of Static IP settings

Follow the steps below to change the Static IP settings.

Step	Action
1	Change the <b>IP address</b> , the <b>Subnet mask</b> , <b>Router</b> , or <b>Workgroup</b> by tapping the corresponding field.
2	Enter the new address by using the keypad.
3	Tap <b>Done</b> to save the changes, or <b>Cancel</b> to go back to the Network window.

## 6.5 Maintenance

### General information

The following information is available in the top of the **Maintenance** window:

- Software version
- Firmware version
- Instrument serial number

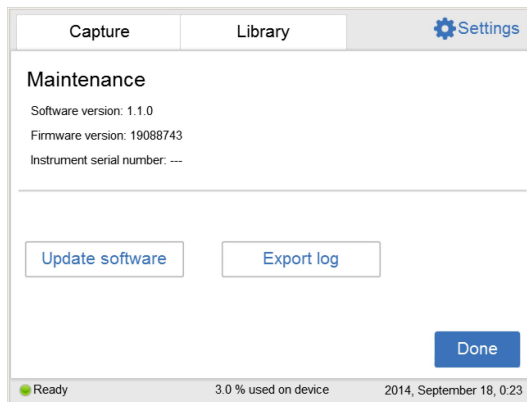

### Update software

Follow the steps below to update the software.

Step	Action
1	Connect the USB flash drive provided by Cytiva containing the update file.
2	Tap the <b>Update software</b> button.

*Result:*

The following window appears:

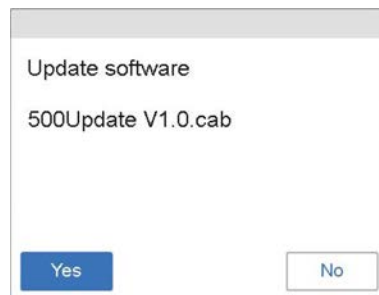

3	Tap <b>Yes</b> to update the software.
---	--

Step	Action
4	Tap <b>Ok</b> to return to the <b>Settings</b> window.

## Export log

Follow the steps below to export a log.

Step	Action
1	Tap <b>Export log</b> . <i>Result:</i> A text file is created containing the export log file.
2	Tap <b>Ok</b> to return to the <b>Settings</b> window.

# 7 Maintenance

## About this chapter

This chapter provides information about maintenance that should be performed by users of ImageQuant 500.

To ensure that the system works according to specifications, planned maintenance should be performed annually by a Cytiva service engineer, or service personnel authorized by Cytiva. A list of planned maintenance actions is presented in this chapter.



### NOTICE

Before performing any maintenance on or inside the ImageQuant 500, be sure to turn off the power switch and remove the power plug from the electrical outlet.

## In this chapter

Section		See page
7.1	Safety precautions	115
7.2	Cleaning before planned service	116
7.3	Cleaning the exterior	117
7.4	Cleaning sample trays and filter	118
7.5	Regular inspections	119

## 7.1 Safety precautions



**WARNING**

**Disconnect power.** Always disconnect power from the instrument before performing any maintenance task.



**WARNING**

For continued protection from fire hazard, replace only with same type and rating of fuse.



**WARNING**

If a fuse requires repeated replacement, do not continue to use the instrument. Contact an authorized service engineer.

## 7.2 Cleaning before planned service

### **Cleaning before planned maintenance/service**

To ensure the protection and safety of service personnel, all equipment and work areas must be clean and free of any hazardous contaminants before a Service Engineer starts maintenance work.

Please complete the checklist in the *On Site Service Health and Safety Declaration Form* or the *Health and Safety Declaration Form for Product Return or Servicing*, depending on whether the instrument is going to be serviced on site or returned for service, respectively.

### **Health and safety declaration forms**

Health and safety declaration forms are available for copying or printing in the *Reference information* chapter of this manual, or on digital media supplied with the user documentation.



## 7.3 Cleaning the exterior



### CAUTION

Wear gloves while cleaning. There may be residues of hazardous chemicals.



### CAUTION

When the touch screen is cleaned do not press too hard onto the surface. This may cause the surface to break and lead to injury.



### NOTICE

Do not use organic solvents. These may damage the surface.

Use a soft dry cloth to clean the exterior of ImageQuant 500. For marks that are hard to remove, wipe with a soft cloth slightly dampened with a neutral detergent, then wipe with a new clean, dry cloth.

To clean the interior of the instrument, use a non-fluorescent cleaning agent for biochemical use. If using a neutral domestic detergent, the detergent residue may fluoresce when an image is captured.

## 7.4 Cleaning sample trays and filter



### CAUTION

Wear gloves while cleaning. There may be residues of hazardous chemicals.



### NOTICE

Do not use organic solvents. These may damage the surface.



### NOTICE

Do not use abrasive cleaning materials, such as a scouring pad, for cleaning. This may scratch the surface.

After using a sample tray, wash it in water using a soft sponge soaked in a cleaning agent. It is recommended to use a neutral domestic detergent for cleaning the trays. The cleaning agent should be non-fluorescent to avoid that residues fluoresce when images are captured.

The trays can also be washed using one of the following:

- 70% ethanol
- Mild detergent
- Isopropanol
- 6% H<sub>2</sub>O<sub>2</sub>

After cleaning, rinse the tray in water and allow to air dry.

To clean the filter use a soft sponge soaked in a non-fluorescent neutral detergent.

## 7.5 Regular inspections

Regularly inspect the ImageQuant 500 to ensure the following:

- The power supply plug is firmly secured in the power outlet.
- The power cord and supply plug do not become overheated.
- The power cord is not damaged in any way.
- The ventilation holes in the equipment are free from dust and dirt.

# 8 Troubleshooting

## About this chapter

This chapter describes various problems that could occur with the ImageQuant 500 system. Suggestions of possible solutions are provided.

## In this chapter

<b>Section</b>		<b>See page</b>
8.1	Report an error	121
8.2	Problems with the captured image	122
8.3	Strange sounds and odors	123
8.4	Problems with ImageQuant 500	124
8.5	Problems with ImageQuant 500 Control Software	125

## 8.1 Report an error

Follow this procedure, if an error occurs:

1. Take note of the error code and error message on the monitor.
2. Turn off the power to ImageQuant 500 and turn it back on again after about ten seconds.
3. If the error persists and cannot be resolved with this troubleshooting guide, contact your Cytiva representative.

## 8.2 Problems with the captured image

Problem	Cause	Action
An appropriate image does not appear	Image is overexposed	Shorten the exposure time
	Image is underexposed	Make the exposure time longer
	The tray or filter are dirty	Clean the tray and filter, as instructed in <a href="#">Chapter 7 Maintenance, on page 114</a>
	The size of the object to be exposed does not coincide with the exposed area	Place the membrane or the gel correctly on the tray and place the tray at the correct tray position, as instructed in <a href="#">Section 5.3 Place the sample on a tray, on page 48</a>
Light leaks on the image	Exposure to direct sunlight	Avoid placing ImageQuant 500 in direct sunlight
The image appears misty	Dew condensation in the optical system	Wait until the operation environment meets the required specifications
Unevenness is seen on the image	One of the UV LEDs is broken.	Turn the power off and contact your Cytiva representative
	The sample tray is not correctly positioned	Place the tray correctly at the appropriate tray position

## 8.3 Strange sounds and odors

Problem	Cause	Action
The camera generates a strange noise	Camera failure	Turn off the ImageQuant 500 power switch immediately and contact your Cytiva representative
The camera generates a strange odor		
The camera emits smoke		
ImageQuant 500 generates a strange odor	ImageQuant 500 failure	Turn off the ImageQuant 500 power switch immediately and contact your Cytiva representative
ImageQuant 500 emits smoke		

## 8.4 Problems with ImageQuant 500

If the error persists even after the following actions have been taken, contact your Cytiva representative.

Problem	Cause	Action
ImageQuant 500 do not start	Power cord not connected	Connect the power cord correctly
ImageQuant 500 door cannot be opened and closed.	Foreign object is present in the door hinges	Remove the foreign object
	The hinges are damaged.	Contact your Cytiva representative
The light source is lit even when the ImageQuant 500 door is opened	Interlock failure	Turn off the power immediately and contact your Cytiva representative



## 8.5 Problems with ImageQuant 500 Control Software

If the error persists even after the following actions have been taken, contact your Cytiva representative.

Problem	Cause	Action
After exposure, no image is displayed on the monitor	The light source does not function properly	Contact your Cytiva representative
	The sample is not in position	Check the sample position
The machine instructs to insert the filter even though it is inserted	The white insert holes may be covered	Move or change the sample size so that the white insert holes are not covered
	The tray may have residues of fluorescent substances	Clean the tray
	The sample may cover parts of the tray that is needed for filter detection	Move or change the sample size so it does not cover relevant parts

# 9 Reference information

## About this chapter

This chapter lists the technical specifications of ImageQuant 500. The chapter also includes ordering information, and Health and Safety Declaration form for service.

## In this chapter

<b>Section</b>		<b>See page</b>
9.1	Specifications	127
9.2	Environmental conditions	128
9.3	Recycling information	130
9.4	Regulatory information	132
9.5	Health and Safety Declaration Form	143

## 9.1 Specifications

Parameter	Data
Input voltage	100 to 240 V~
Voltage variation	±10% from nominal voltage
Frequency	50/60 Hz
Max power	200 W
Dimensions (W x D x H)	300 x 280 x 570 mm
Weight	15 kg
Image sensor	Peltier cooled, 8.3 megapixel CCD
Image sensor temperature	-25%
Cooling down time	<5 minutes
Lens	F1.4/30 mm
Light source	Blue Epi light: 460nm
	UV Epi light: 365nm
	White Epi light: 470 to 635 nm
Operation	Fully automated (auto exposure, no focus or other adjustment or calibrations needed)
Maximum sample size	105 X 105 mm
Greyscale	65 536 levels (16 bit)
Exposure time	1/10 seconds to 1 hour
Dynamic range	4.8 orders of magnitude
Image output	Grey scale 16 bit (tif)
	Color image (jpg)

## 9.2 Environmental conditions

Parameter	Condition
Free space required around ImageQuant 500.	Operation panel side: 20 cm
	Right: 10 cm
	Left: 10 cm
	Side opposite to operation panel: 10 cm
	Top: 10 cm
Placement	A stable laboratory bench with a load capacity of 490 N (50 kg) or higher
	Levelness tolerance: 2°
Other conditions	<ol style="list-style-type: none"> <li>1. Take into consideration the work flow and ancillary facilities when planning the installation.</li> <li>2. Required construction and electricity/air conditioning work must be completed prior to installation.</li> <li>3. It is not desirable, to have a heat source near the ImageQuant 500 air intakes, even if the other environmental requirements have been met.</li> <li>4. Do not install the equipment near a window to avoid direct sunlight. Attach a blind to nearby windows.</li> <li>5. Do not place objects near the power outlet to maintain easy access to the power cord for disconnection in case of emergency.</li> </ol>
Floor vibration conditions	<p>(1) Operating time Oscillation: 0.03G (5 to 60 Hz) Impact :1G</p> <p>(2) Non-operating time Oscillation: 0.4G (5 to 60 Hz) Impact :2G</p>
Operating temperature/ humidity conditions	<p>Temperature: 18°C to 28°C (with temperature fluctuation below 10°C per hour or lower)</p> <p>Humidity: 15% to 70% RH (no dew condensation)</p> <p><b>Note:</b> <i>When the above conditions cannot be satisfied, take appropriate action.</i></p>

Parameter	Condition
Transportation/storage conditions	Temperature: -25°C to 70°C Humidity: 5% to 95% RH (no dew condensation)  <b>Note:</b> <i>When the above conditions cannot be satisfied, take appropriate action.</i>
Installation location conditions	<ol style="list-style-type: none"> <li>1. Do not install the equipment where the temperature can vary widely</li> <li>2. Do not install the equipment near a heat source, such as a radiator</li> <li>3. Do not install the equipment where it may get wet or flooded.</li> <li>4. Do not install the equipment where it may be exposed to corrosive gas</li> <li>5. Do not install the equipment in a dusty environment</li> <li>6. Do not install the equipment in a place constantly or excessively exposed to vibration or impacts</li> <li>7. Do not install the equipment in a place exposed to direct sunlight</li> </ol>
Operation site	Indoor use
Maximum operating altitude	2000 m or lower
Overvoltage category	Transient overvoltage category II
Rated pollution applied	Pollution Degree 2
Noise	70 dB(A) or lower Fast Lmax ≤60dB(A), and average Leq ≤ 54dB(A)
Degrees of protection provided by enclosure	IP21

## 9.3 Recycling information

### Introduction

This section contains information about the decommissioning of the product.



#### **CAUTION**

Always use appropriate personal protective equipment when decommissioning the equipment.

### Decontamination

The product must be decontaminated before decommissioning. All local regulations must be followed with regard to scrapping of the equipment.

### Disposal of the product

When taking the product out of service, the different materials must be separated and recycled according to national and local environmental regulations.

### Disposal of electrical components



Waste electrical and electronic equipment must not be disposed of as unsorted municipal waste and must be collected separately. Please contact an authorized representative of the manufacturer for information concerning the decommissioning of the equipment.

### Instructions for disposal

Follow the instructions below for disposal of the ImageQuant 500

<b>Step</b>	<b>Action</b>
1	Separate all electronic components (terminal strips, power supplies, transmitters, pumps, probes / sensors, etc.) from the system cabinet.
2	Decontaminate the ImageQuant 500 Cabinet and system cabinet following appropriate procedures depending on what type of environment the unit was located in. Follow local and/or national/federal requirements for disposal of the ImageQuant 500 Cabinet and the system cabinet.

<b>Step</b>	<b>Action</b>
3	Dispose of electronic components as specified by local regulations depending on material used in the construction of the components. Follow local and/or national/federal requirements for disposal of the electronic components.

## 9.4 Regulatory information

### Introduction

This section lists the regulations and standards that apply to the product.

### In this section

<b>Section</b>	<b>See page</b>
9.4.1 Contact information	133
9.4.2 European Union and European Economic Area	134
9.4.3 Great Britain	135
9.4.4 Eurasian Economic Union Евразийский экономический союз	136
9.4.5 Regulations for North America	138
9.4.6 Regulatory statements	139
9.4.7 Declaration of Hazardous Substances (DoHS)	140
9.4.8 Other regulations and standards	142



## 9.4.1 Contact information

### Contact information for support

To find local contact information for support and sending troubleshooting reports, visit [cytiva.com/contact](https://cytiva.com/contact).

### Manufacturing information

The table below summarizes the required manufacturing information.

Requirement	Information
Name and address of manufacturer	Cytiva Sweden AB Björkgatan 30 SE 751 84 Uppsala Sweden
Telephone number of manufacturer	+ 46 771 400 600

## 9 Reference information

### 9.4 Regulatory information

#### 9.4.2 European Union and European Economic Area

## 9.4.2 European Union and European Economic Area

### Introduction

This section describes regulatory information for the European Union and European Economic Area that applies to the equipment.

### Conformity with EU Directives

See the EU Declaration of Conformity for the directives and regulations that apply for the CE marking.

If not included with the product, a copy of the EU Declaration of Conformity is available on request.

### CE marking



The CE marking and the corresponding EU Declaration of Conformity is valid for the instrument when it is:

- used according to the *Operating Instructions* or user manuals, and
- used in the same state as it was delivered, except for alterations described in the *Operating Instructions* or user manuals.

## 9.4.3 Great Britain

### Introduction

This section describes regulatory information for Great Britain that applies to the equipment.

### Conformity with UK Regulations

See the UK Declaration of Conformity for the regulations that apply for the UKCA marking.

If not included with the product, a copy of the UK Declaration of Conformity is available on request.

### UKCA marking



The UKCA marking and the corresponding UK Declaration of Conformity is valid for the instrument when it is:

- Used according to the *Operating Instructions* or user manuals, and
- Used in the same state as it was delivered, except for alterations described in the *Operating Instructions* or user manuals.

## 9 Reference information

### 9.4 Regulatory information

#### 9.4.4 Eurasian Economic Union

Евразийский экономический союз

## 9.4.4 Eurasian Economic Union Евразийский экономический союз

This section describes the information that applies to the product in the Eurasian Economic Union (the Russian Federation, the Republic of Armenia, the Republic of Belarus, the Republic of Kazakhstan, and the Kyrgyz Republic).

### Introduction

This section provides information in accordance with the requirements of the Technical Regulations of the Customs Union and (or) the Eurasian Economic Union.

### Введение

В данном разделе приведена информация согласно требованиям Технических регламентов Таможенного союза и (или) Евразийского экономического союза.

### Manufacturer and importer information

The following table provides summary information about the manufacturer and importer, in accordance with the requirements of the Technical Regulations of the Customs Union and (or) the Eurasian Economic Union.

Requirement	Information
Name, address and telephone number of manufacturer	See <i>Manufacturing information</i>
Importer and/or company for obtaining information about importer	Cytiva RUS LLC 109004, Moscow internal city area Tagansky municipal district Stanislavsky str., 21, building 3, premises I, office 57 Russian Federation Telephone: +7 499 609 15 50 E-mail: <a href="mailto:rucis@cytiva.com">rucis@cytiva.com</a>

### Информация о производителе и импортере

В следующей таблице приводится сводная информация о производителе и импортере, согласно требованиям Технических регламентов Таможенного союза и (или) Евразийского экономического союза.

Требование	Информация
Наименование, адрес и номер телефона производителя	См. Информацию об изготовлении
Импортер и/или лицо для получения информации об импортере	<p>ООО "Цитива РУС"</p> <p>109004, город Москва</p> <p>вн.тер.г. муниципальный округ Таганский</p> <p>улица Станиславского, дом 21, строение 3, помещение I, комната 57</p> <p>Российская Федерация</p> <p>Телефон: +7 499 609 15 50</p> <p>Адрес электронной почты: <a href="mailto:rucis@cytiva.com">rucis@cytiva.com</a></p>

## Description of symbol on the system label

### Описание обозначения на этикетке системы



This Eurasian compliance mark indicates that the product is approved for use on the markets of the Member States of the Customs Union of the Eurasian Economic Union

Данный знак о Евразийском соответствии указывает, что изделие одобрено для использования на рынках государств-членов Таможенного союза Евразийского экономического союза

## 9.4.5 Regulations for North America

### Introduction

This section describes the information that applies to the product in the USA and Canada.

### NRTL certification



This symbol indicates that the ImageQuant 500 has been certified by a Nationally Recognized Testing Laboratory (NRTL).

NRTL means an organization, which is recognized by the US Occupational Safety and Health Administration (OSHA) as meeting the legal requirements of Title 29 of the Code of Federal Regulations (29 CFR), Part 1910.7.

### FCC compliance

This device complies with part 15 of the FCC Rules. Operation is subject to the following two conditions: (1) This device may not cause harmful interference, and (2) this device must accept any interference received, including interference that may cause undesired operation.

**Note:** *The user is cautioned that any changes or modifications not expressly approved by Cytiva could void the user's authority to operate the equipment.*

This equipment has been tested and found to comply with the limits for a Class A digital device, pursuant to part 15 of the FCC Rules. These limits are designed to provide reasonable protection against harmful interference when the equipment is operated in a commercial environment. This equipment generates, uses, and can radiate radio frequency energy and, if not installed and used in accordance with the instruction manual, may cause harmful interference to radio communications. Operation of this equipment in a residential area is likely to cause harmful interference in which case the user will be required to correct the interference at his own expense.

### CAN ICES/NMB compliance

This product complies with the Canadian standard ICES-003/NMB-003 concerning electromagnetic compatibility.

## 9.4.6 Regulatory statements

### Introduction

This section shows regulatory statements that apply to regional requirements.

### EMC emission, CISPR 11: Group 1, Class A statement



#### NOTICE

This equipment is not intended for use in residential environments and may not provide adequate protection to radio reception in such environments.

### South Korea

Regulatory information to comply with the Korean technical regulations.



#### NOTICE

Class A equipment (equipment for business use).

This equipment has been evaluated for its suitability for use in a business environment.

When used in a residential environment, there is a concern of radio interference.



#### 유의사항

A급 기기(업무용 방송통신기자재)

이 기기는 업무용 환경에서 사용할 목적으로 적합성평가를 받은 기기

로서 가정용 환경에서 사용하는 경우 전파간섭의 우려가 있습니다.

## 9.4.7 Declaration of Hazardous Substances (DoHS)

This section describes the information that applies to the product in China.

根据 SJ/T11364-2014 《电子电气产品有害物质限制使用标识要求》特提供如下有关污染控制方面的信息。

The following product pollution control information is provided according to SJ/T11364-2014 Marking for Restriction of Hazardous Substances caused by electrical and electronic products.

### 电子信息产品污染控制标志说明 Explanation of Pollution Control Label



该标志表明本产品含有超过中国标准 GB/T 26572 《电子电气产品中限用物质的限量要求》中限量的有害物质。标志中的数字为本产品的环保使用期，表明本产品在正常使用的条件下，有毒有害物质不会发生外泄或突变，用户使用本产品不会对环境造成严重污染或对其人身、财产造成严重损害的期限。单位为年。

为保证所声明的环保使用期限，应按产品手册中所规定的环境条件和方法进行正常使用，并严格遵守产品维修手册中规定的定期维修和保养要求。

产品中的消耗件和某些零部件可能有其单独的环保使用期限标志，并且其环保使用期限有可能比整个产品本身的环保使用期限短。应到期按产品维修程序更换那些消耗件和零部件，以保证所声明的整个产品的环保使用期限。

本产品在使用寿命结束时不可作为普通生活垃圾处理，应被单独收集妥善处理。

This symbol indicates the product contains hazardous materials in excess of the limits established by the Chinese standard GB/T 26572 Requirements of concentration limits for certain restricted substances in electrical and electronic products. The number in the symbol is the Environment-friendly Use Period (EFUP), which indicates the period during which the hazardous substances contained in electrical and electronic products will not leak or mutate under normal operating conditions so that the use of such electrical and electronic products will not result in any severe environmental pollution, any bodily injury or damage to any assets. The unit of the period is "Year".

In order to maintain the declared EFUP, the product shall be operated normally according to the instructions and environmental conditions as defined in the product manual, and periodic maintenance schedules specified in Product Maintenance Procedures shall be followed strictly.

Consumables or certain parts may have their own label with an EFUP value less than the product. Periodic replacement of those consumables or parts to maintain the declared EFUP shall be done in accordance with the Product Maintenance Procedures.

This product must not be disposed of as unsorted municipal waste, and must be collected separately and handled properly after decommissioning.

### 有害物质的名称及含量 Name and Concentration of Hazardous Substances

产品中有害物质的名称及含量

Table of Hazardous Substances' Name and Concentration



部件名称 Component name	有害物质 Hazardous substance					
	铅 (Pb)	汞 (Hg)	镉 (Cd)	六价铬 (Cr(VI))	多溴联苯 (PBB)	多溴二苯醚 (PBDE)
29655893	X	O	O	O	O	O

- O:** 表示该有害物质在该部件所有均质材料中的含量均在 GB/T 26572 规定的限量要求以下。
- X:** 表示该有害物质至少在该部件的某一均质材料中的含量超出 GB/T 26572 规定的限量要求。
- 此表所列数据为发布时所能获得的最佳信息。
- O:** Indicates that this hazardous substance contained in all of the homogeneous materials for this part is below the limit requirement in GB/T 26572.
- X:** Indicates that this hazardous substance contained in at least one of the homogeneous materials used for this part is above the limit requirement in GB/T 26572
- Data listed in the table represents best information available at the time of publication.

## 9 Reference information

### 9.4 Regulatory information

#### 9.4.8 Other regulations and standards

## 9.4.8 Other regulations and standards

### Introduction

This section describes the standards that apply to the product.

### Light sources

The safety of the LED light sources in this equipment has been assessed by risk analysis in accordance with EN 61010-1.

ImageQuant 500 is equipped with three LED light sources:

LED	Wavelength
Blue Epi light	460 nm
UV Epi light	365 nm
White Epi light	470 to 635 nm

## 9.5 Health and Safety Declaration Form

### On site service



### On Site Service Health & Safety Declaration Form

<b>Service Ticket #:</b>	
--------------------------	--

To make the mutual protection and safety of Cytiva service personnel and our customers, all equipment and work areas must be clean and free of any hazardous contaminants before a Service Engineer starts a repair. To avoid delays in the servicing of your equipment, complete this checklist and present it to the Service Engineer upon arrival. Equipment and/or work areas not sufficiently cleaned, accessible and safe for an engineer may lead to delays in servicing the equipment and could be subject to additional charges.

Yes	No	Review the actions below and answer "Yes" or "No". Provide explanation for any "No" answers in box below.
<input type="radio"/>	<input type="radio"/>	<b>Instrument has been cleaned of hazardous substances.</b> Rinse tubing or piping, wipe down scanner surfaces, or otherwise make sure removal of any dangerous residue. Make sure the area around the instrument is clean. If radioactivity has been used, perform a wipe test or other suitable survey.
<input type="radio"/>	<input type="radio"/>	<b>Adequate space and clearance is provided to allow safe access</b> for instrument service, repair or installation. In some cases this may require customer to move equipment from normal operating location prior to Cytiva arrival.
<input type="radio"/>	<input type="radio"/>	<b>Consumables, such as columns or gels, have been removed or isolated from the instrument and from any area that may impede access to the instrument.</b>
<input type="radio"/>	<input type="radio"/>	<b>All buffer / waste vessels are labeled.</b> <b>Excess containers have been removed from the area to provide access.</b>
<b>Provide explanation for any "No" answers here:</b>		
<b>Equipment type / Product No:</b>		<b>Serial No:</b>
I hereby confirm that the equipment specified above has been cleaned to remove any hazardous substances and that the area has been made safe and accessible.		
<b>Name:</b>		<b>Company or institution:</b>
<b>Position or job title:</b>		<b>Date (YYYY/MM/DD):</b>
<b>Signed:</b>		

Cytiva and the Drop logo are trademarks of Global Life Sciences IP Holdco LLC or an affiliate.

© 2020 Cytiva.  
All goods and services are sold subject to the terms and conditions of sale of the supplying company operating within the Cytiva business. A copy of those terms and conditions is available on request. Contact your local Cytiva representative for the most current information.

For local office contact information, visit [cytiva.com/contact](http://cytiva.com/contact).  
28980026 AD 04/2020

## Product return or servicing



## Health & Safety Declaration Form for Product Return or Servicing

<b>Return authorization number:</b>		<i>and/or</i> <b>Service Ticket/Request:</b>	
-------------------------------------	--	---	--

To make sure the mutual protection and safety of Cytiva personnel, our customers, transportation personnel and our environment, all equipment must be clean and free of any hazardous contaminants before shipping to Cytiva. To avoid delays in the processing of your equipment, complete this checklist and include it with your return.

- Note that items will NOT be accepted for servicing or return without this form
- Equipment which is not sufficiently cleaned prior to return to Cytiva may lead to delays in servicing the equipment and could be subject to additional charges
- Visible contamination will be assumed hazardous and additional cleaning and decontamination charges will be applied

Yes	No	Specify if the equipment has been in contact with any of the following:	
<input type="radio"/>	<input type="radio"/>	Radioactivity (specify)	
<input type="radio"/>	<input type="radio"/>	Infectious or hazardous biological substances (specify)	
<input type="radio"/>	<input type="radio"/>	Other Hazardous Chemicals (specify)	

**Equipment must be decontaminated prior to service / return. Provide a telephone number where Cytiva can contact you for additional information concerning the system / equipment.**

<b>Telephone No:</b>			
<b>Liquid and/or gas in equipment is:</b>	<input type="checkbox"/>	Water	
	<input type="checkbox"/>	Ethanol	
	<input type="checkbox"/>	None, empty	
	<input type="checkbox"/>	Argon, Helium, Nitrogen	
	<input type="checkbox"/>	Liquid Nitrogen	
	<input type="checkbox"/>	Other, specify	

<b>Equipment type / Product No:</b>		<b>Serial No:</b>	
-------------------------------------	--	-------------------	--

**I hereby confirm that the equipment specified above has been cleaned to remove any hazardous substances and that the area has been made safe and accessible.**

<b>Name:</b>		<b>Company or institution:</b>	
<b>Position or job title:</b>		<b>Date (YYYY/MM/DD)</b>	
<b>Signed:</b>			

Cytiva and the Drop logo are trademarks of Global Life Sciences IP Holdco LLC or an affiliate.

© 2020 Cytiva.  
 All goods and services are sold subject to the terms and conditions of sale of the supplying company operating within the Cytiva business. A copy of those terms and conditions is available on request. Contact your local Cytiva representative for the most current information.

For local office contact information, visit [cytiva.com/contact](http://cytiva.com/contact).  
 28980027 AD 04/2020

**To receive a return authorization number or service number, call local technical support or customer service.**

# Index

## A

Accessories, 28

## C

Capture an image, 51

CE, 134

conformity, 134

marking, 134

Chemiluminescence, 52, 56, 62, 66

automatic exposure, 52

incremental exposure, 66

manual exposure, 62

semi-automatic exposure, 56

Colormetric, 84

automatic exposure, 84

Connect to a network, 38–40

DHCP network, 39

Static IP network, 40

## D

Date and time, 110

Disposal, 130

instructions, 130

## E

Electrical Cabinet, 130

disposal, 130

Emergency, 18

procedures, 18

Emergency procedure, 18

Emergency procedures, 18

power failure, 18

## F

FCC compliance, 138

File formats, 95

File name, 95

Filter, 28

Fluorescence, 71, 74, 79

automatic exposure, 71

manual exposure, 79

semi-automatic exposure, 74

## I

ImageQuant 500, 21, 28, 104

Accessories, 28

Feature overview, 21

Software, 104

Important user information, 5

Installation, 29–31, 34, 42

Instrument set up, 34

Site requirements, 30

Transport, 42

Unpacking, 31

## K

Keypad, 102

## M

Maintenance, 112, 117, 118

ImageQuant 500, 117

Sample trays and filter, 118

Manufacturing information, 133

## N

Network, 111

Notes and tips, 6

## O

On site service, 143

Operation, 47, 48, 103

Flow chart, 47

Place the sample, 48

Sample and tray

combinations, 48

Shut down the instrument,

103

Orange filter, 28

## P

Place the sample, 48

Product return or servicing, 144

Purpose of this manual, 6

## R

- Recycling information, *130*
  - decontamination, *130*
  - disposal of electrical components, *130*
- Regulatory information, *132*

## S

- Safety notices, *9*
- Safety precautions, *9*
  - introduction, *9*
- Sample and tray combinations, *48*
- Save location, *107*
- Save window, *94*
- Settings, *107, 110–112*
  - Date and time, *110*
  - Maintenance, *112*
  - Network, *111*
  - Save location, *107*
- Settings window, *105*
- Site requirements, *30*
- Software, *94, 95, 102, 104*
  - File formats, *95*
  - Keypad, *102*
  - Save window, *94*
- Specifications, *127*

## T

- Tray, *28*
  - DNA tray, *28*
  - Protein tray, *28*
- Typographical conventions, *6*

## U

- UK, *135*
  - conformity, *135*
- UKCA, *135*
  - marking, *135*
- Unpacking, *31*

## W

- Web tool, *100*
- White insert, *28*

Page intentionally left blank



## [cytiva.com/products](https://www.cytiva.com/products)

Cytiva and the Drop logo are trademarks of Global Life Sciences IP Holdco LLC or an affiliate.

Amersham and ImageQuant are trademarks of Global Life Sciences Solutions USA LLC or an affiliate doing business as Cytiva.

Coomassie and SYBR are trademarks of Thermo Fisher Scientific.

All other third-party trademarks are the property of their respective owners.

© 2021 Cytiva

Any use of ImageQuant 500 is subject to Cytiva Standard Software End-User License Agreement for Life Sciences Software Products. A copy of this Standard Software End-User License Agreement is available on request.

All goods and services are sold subject to the terms and conditions of sale of the supplying company operating within the Cytiva business. A copy of those terms and conditions is available on request. Contact your local Cytiva representative for the most current information.

For local office contact information, visit [cytiva.com/contact](https://www.cytiva.com/contact)

29655392 AA V:1 05/2021