

405™ LS

Operator's Manual



**405™ Microplate Washer LS
Operator's Manual**

**BioTek Instruments, Inc.
January 2013
© January 2013
Part Number 1171030
Revision B**

Notices

BioTek[®] Instruments, Inc.

Highland Park, P.O. Box 998

Winooski, Vermont 05404-0998 USA

All Rights Reserved

© 2013, BioTek[®] Instruments, Incorporated. No part of this publication may be reproduced, transcribed, or transmitted in any form, or by any means electronic or mechanical, including photocopying and recording, for any purpose other than the purchaser's use without written permission of BioTek Instruments, Inc.

Trademarks

BioTek[®] is a registered trademark and 405[™] Microplate Washer LS is a trademark of BioTek Instruments, Inc.

Microsoft[®], Internet Explorer[®], Windows[®], Windows 7, Windows Vista[®], Windows XP, and Excel[®] are either registered trademarks or trademarks of Microsoft Corporation in the United States and/or other countries.

All other trademarks are the property of their respective holders.

Restrictions and Liabilities

Information in this document is subject to change and does not represent a commitment by BioTek Instruments, Inc. Changes made to the information in this document will be incorporated in new editions of the publication. No responsibility is assumed by BioTek for the use or reliability of software or equipment that is not supplied by BioTek or its affiliated dealers.

Contents

Notices	ii
All Rights Reserved	ii
Trademarks	ii
Restrictions and Liabilities	ii
Contact Information	viii
Customer Service and Sales	viii
Service/TAC	viii
European Coordination Center/Authorized European Representative	viii
Document Conventions	ix
Document Revision History	ix
Intended Use Statement	ix
Quality Control	x
Warranty and Product Registration	x
Repackaging and Shipping	x
Warnings	x
Hazards and Precautions	xi
Hazards	xi
Precautions	xii
CE Mark	xiv
Directive 2004/108/EC: Electromagnetic Compatibility	xiv
Directive 2006/95/EC Low Voltage (Safety)	xv
Directive 2002/96/EC: Waste Electrical and Electronic Equipment	xv
Directive 98/79/EC: In Vitro Diagnostics (if labeled for this use)	xv
Electromagnetic Interference and Susceptibility	xv
USA FCC CLASS A	xv
Canadian Department of Communications Class A	xvi
User Safety	xvi
Safety Symbols	xvii
Introduction	1
Introducing the 405™ Microplate Washer LS	2
Instrument Models	3
BioStack Compatibility	3
Package Contents	5
Waste and Dispense System Accessories	6
Optional Accessories	7
Physical Specifications	9
Performance Specifications	10
BioTek's Customer Resource Center	12
Installation	13
Unpack and Inspect the Instrument	14
Remove the Shipping Hardware	14
Setting Up the 405 LS	18
Install the Microplate Carrier	18
Connect the Vacuum Pump, Tubes, and Bottles	18
Waste System	19

Install the Vacuum Line Filter	21
Install the Fluid Supply System	22
Final Check	24
Attach the Mist Shield	24
Install Software/Connect to Computer	25
Connect to Host Computer	25
Connect to Power	26
Define Instrument Settings	26
LHC Users Only	26
Standard Vacuum Pump Users	27
Define Startup Preferences (LHC users only)	27
Verify Performance	29
Verify the Washer	30
Run the Verify Test ("Q" Models Only)	30
Repacking the 405 Washer	32
Operation	37
Basic Operation	38
About the 405 LS Wash Step	38
Optimize Performance	39
405 Recommendations for Priming the Washer	39
Optimize protocols to improve evacuation	40
Running Predefined Protocols	41
Creating Protocols: Washing, Aspirating and Dispensing Fluid	41
LHC Users Only: Customize the Predefined Protocols	41
Predefined Protocols Listing	43
Predefined Sample Protocols	44
Introducing the 405 LS Keypad	46
Quick Wash (Keypad only)	47
Quick Prime (Keypad only)	48
Create or Edit a Protocol (Keypad Only)	48
How to name a protocol (Keypad only)	49
Define the Plate Type and Plate Map (or Partial Plate)	50
How to shake the plate	51
How to enter negative numbers (Keypad only)	52
How to copy a protocol	52
How to delete a protocol	52
Using LHC to Control the 405™ Washer	54
Introducing the LHC Workspace	54
Communications Port	55
405 Steps	55
LHC Protocols	56
LHC Protocols Explained	57
Target Instrument Settings	58
How to define a Protocol (LHC only)	59
How to use the Adjust Utility- LHC	60
Upload-Download Protocols (LHC Only)	62
Wash Step Parameters Table	62

Shake/Soak Step Parameters	66
Pre-Dispense	67
Washer Flow Rates	68
How to define a Final Aspiration step	69
Add a secondary aspiration to a wash cycle	70
Bottom Wash	70
Verify Performance	72
Handling the Verify Test Plate	73
Verify™ Technology Flowchart Diagram	75
Verify Test Corrective Action	75
About Verify™ Technology	76
Sensitivity: Verify Sensor vs. Absorbance Reader	78
Configure Verify™ Technology Utilities	79
Operating with the BioStack	81
BioStack Alignment Utility	82
Cell Wash	84
Cell Wash Strategies	85
Biomagnetic Separation - Magnetic Bead Assays	89
Perform Magnetic Bead Assays	90
Optimize Magnetic Bead Protocols	90
Flat Magnets	91
Ring Magnets	92
Magnet Height Offset	93
Determine Magnet Height Offset	93
Manifold Stop Screw Adjustment Kit	94
Vacuum Filtration for Filter Plate Assays	97
Install the side bracket	98
Set up the Vacuum Filtration module	99
Enable Vacuum Filtration	101
Create a Vacuum Filtration Protocol	101
Install Vacuum Filtration Plate Carrier	103
Control the Vacuum Level	104
Washer Settings	105
Change the Washer Manifold Setting (Keypad)	107
Change the Plate Carrier Setting (Keypad)	107
Change the Plate Clearance Setting (Keypad)	108
Adjust Utility	108
Run the Adjust Utility (Using the Keypad)	109
Plate Types and Processing Patterns	110
Plate Types Table	111
About Wash Processing Patterns	111
Maintenance	115
Overview	117
Recommended Maintenance Schedule	119
Daily Maintenance	121
Overnight/Multi-Day Maintenance	121
AutoPrime	122

AutoPrime for Overnight-Weekend Maintenance	123
Turn on AutoPrime for the Washer	123
Removing Protein Residuals and Fungi Growth	124
AutoClean the Washer	125
Quick Clean (Keypad Only)	126
Create an AutoClean protocol	127
Periodic Maintenance	128
Clean the Bottles	128
Clean the Plate Carrier	129
Clean the Vacuum Filtration Carrier	129
Clean the exterior surfaces and mist shield	130
Clean the Buffer Bottle Filter	130
Remove and clean the washer manifold	131
Maintaining the Vacuum Filtration System	133
Clean the Vacuum Filtration Carrier	133
Maintain the Verify™ Technology Components	133
Clean the Verify™ Level Sensor	133
Replacement Procedure for Verify Test Plate	134
Volume coefficients - Slope and Offset	137
Decontamination	138
Tools and Supplies	138
Decontaminate Exterior Surfaces	139
Decontaminate Tubing and Manifold	140
Alternate Decontamination Procedure for Tubing and Manifold	141
Decontaminate the Vacuum Filtration System	142
Long Shutdown Procedure (Prepare for Storage or Shipment)	143
Storing the Instrument	144
Replace Components	144
Remove/Change Wash Manifold	145
Replace the Vacuum Pump Fuse	145
Vacuum Filtration Carrier: Replace the Gasket	146
Qualification	147
Qualification Overview	148
Qualification Schedule	149
System Self-Test, Verify Information	149
Record Basecode	150
Sensor Test: Fluid, Waste, Plate Detection	150
Ultrasonic Cleaner Test	151
Liquid Testing the 405™ Microplate Washer LS	152
Which Tests to Perform?	152
Important Recommendations for All Liquid Tests	153
Washer Liquid Tests	154
Dispense Precision Test	154
Evacuation Efficiency Test	154
Predefined Test Protocols	154
Washer Qualification Test Materials	155
Dispense Precision Test (96)	157

Evacuation Efficiency Test (96)	158
Evacuation Diagnostic Test	159
Buffer Switching Dispense Test	160
Dispense Precision Test (192)	161
Evacuation Efficiency Test (192)	162
Evacuation Diagnostic Test (192)	163
Vacuum Filtration Evacuation Efficiency Test	165
Qualify the Verify™ Technology Sensor	167
Troubleshooting	179
Troubleshooting	180
General Operation Troubleshooting	182
Washer Problems	183
Communication Errors	188
Error Codes	191
System Error Codes	192
405 LS-LHC Software Error Codes	200
Index	205

Contact Information

BioTek® Instruments, Inc.

Highland Park, P.O. Box 998

Winooski, Vermont 05404-0998 USA

Customer Service and Sales

Internet: www.biotek.com
Phone: 888-451-5171 (toll free in the U.S.)
802-655-4740 (outside the U.S.)
Fax: 802-655-7941
E-Mail: customercare@biotek.com

Service/TAC

Phone: 800-242-4685 (toll free in the U.S.)
802-655-4740 (outside the U.S.)
Fax: 802-654-0638
E-Mail: tac@biotek.com

European Coordination Center/Authorized European Representative

BioTek® Instruments GmbH

Kocherwaldstrasse 34

D-74177 Bad Friedrichshall

Germany

Internet: www.biotek.de
Phone: +49 (0) 7136 9680
Fax: +49 (0) 7136 968 111
E-Mail: info@biotek.de

Document Conventions

This manual uses the following typographic conventions:

- This note format calls attention to important information.

 Warnings are presented in this style to call attention to potential hazards and other safety concerns.



This icon calls attention to important safety information.

 Tips and suggestions for improving performance are formatted this way.

Navigation instructions: how to get to the function being described

- **Water:** Daily maintenance is the key to keeping the liquid handler performing to specifications. In the maintenance procedures provided in this manual, the requirement to use distilled (dH₂O) or deionized (DI) water can be met by numerous water purification methods, including MilliQ™. A minimum water purity of 2mOhm is expected.

Document Revision History

Rev	Date	Changes
A	5/2012	First issue
B	1/2013	Added content about BioTek's Verify™ Technology, including the Plate Detection sensor and new shipping hardware. Added instructions for running the Verify test, analyzing its test results, maintaining the device, replacing the test plate and qualifying the device. Note: the vacuum filtration plate carrier was modified to accommodate the Verify device. Pinch hazard warning label updated. Packing materials modified for all models.

Intended Use Statement

- The 405™ Microplate Washer LS provides microplate priming, washing, and dispensing for ELISA™, fluorescence and chemiluminescence immunoassays, cellular and

agglutination assays.

- If the instrument has an "IVD" label it may be used for clinical and non-clinical purposes, including research and development. If there is no such label the instrument may only be used for research and development and non-clinical purposes.

Quality Control

It is considered good laboratory practice to run laboratory samples according to instructions and specific recommendations included in the assay package insert for the test to be conducted. Failure to conduct Quality Control checks could result in erroneous test data.

Warranty and Product Registration

Please take a moment to review the Warranty information that shipped with your product. Please also register your product with BioTek to ensure that you receive important information and updates about the product(s) you have purchased.

You can register online through BioTek's Customer Resource Center (CRC) at www.biotek.com or by calling 888/451-5171 or 802/655-4740.

Repackaging and Shipping

If you need to ship the instrument to BioTek for service or repair, contact BioTek for a Return Materials Authorization (RMA) number and use the original packing materials. Other forms of commercially available packaging are not recommended and can void the warranty. If the original packing materials have been damaged or lost, contact BioTek for replacement packing.

Warnings



Operate the instrument on a level, stable surface away from excessive humidity.

When operated in a safe environment, according to the instructions in this document, there are no known hazards associated with the 405 LS. However, the operator should be aware of certain situations that could result in serious injury; these vary depending on the instrument type. See **Hazards** and **Precautions**.

Strict adherence to instrument maintenance and qualification procedures is required to ensure accurate dispense volumes and risk-free operation.

Hazards and Precautions

Hazards

The following hazards are provided to help avoid injury:



Warning! Power Rating. The instrument's power supply or power cord must be connected to a power receptacle that provides voltage and current within the specified rating for the system. Use of an incompatible power receptacle may produce electrical shock and fire hazards.

Warning! Electrical Grounding. Never use a two-prong plug adapter to connect primary power to the external power supply. Use of a two-prong adapter disconnects the utility ground, creating a severe shock hazard. Always connect the power cord directly to an appropriate receptacle with a functional ground.

Warning! Service. Only qualified technical personnel should perform service procedures on internal components.

Warning! Accessories. Only accessories which meet the manufacturer's specifications shall be used with the instrument.

Warning! Lubricants. Do not apply lubricants to the microplate carrier or carrier track. Lubricant on the carrier mechanism will attract dust and other particles, which may obstruct the carrier path and cause the instrument to produce an error.

Warning! Liquids. Avoid spilling liquids on the instrument; fluid seepage into internal components creates a potential for shock hazard or instrument damage. If a spill occurs while a program is running, abort the program and turn the instrument off. Wipe up all spills immediately. Do not operate the instrument if internal components have been exposed to fluid.

Warning! Unspecified Use. Failure to operate this equipment according to the guidelines and safeguards specified in this manual could result in a hazardous condition.

Warning! Direct Drain Waste. If installed, the direct drain waste system pumps waste fluids from the washer directly into a sink or tank, and, potentially into public waste water systems. Because the waste may be a biohazard, you must ensure that you are in compliance with your local or national government's laws regarding safe disposal of the waste.

Warning! Ultrasonic Energy. Ultrasonic energy is present in the ultrasonic cleaner reservoir (if equipped) when AUTOCLEAN/Quick Clean programs are running. Avoid putting your fingers in the bath. Ultrasonic energy can be destructive to human tissue.

Warning! Software Quality Control. The operator must follow the

manufacturer's assay package insert when modifying software parameters and establishing washing or dispensing methods. **Failure to conduct quality control checks could result in erroneous test data.**



Warning! Internal Voltage. Always turn off the power switch and unplug the power supply before cleaning the outer surface of the instrument.



Warning! Potential Biohazards. Some assays or specimens may pose a biohazard. Adequate safety precautions should be taken as outlined in the assay's package insert. This hazard is noted by the symbol shown here. Always wear safety glasses and appropriate protective equipment, such as chemically resistant rubber gloves and apron.



Warning! Pinch Hazard. Some areas of the instrument or its components can present pinch hazards when the instrument is operating. Depending on the instrument or component, these areas are marked with the symbol shown here. Keep hands/fingers clear of these areas when the instrument is operating.

Precautions

The following precautions are provided to help avoid damage to the instrument:



Caution: Service. The instrument should be serviced by BioTek authorized service personnel. Only qualified technical personnel should perform troubleshooting and service procedures on internal components.

Caution: Spare Parts. Only approved spare parts should be used for maintenance. The use of unapproved spare parts and accessories may result in a loss of warranty and potentially impair instrument performance or cause damage to the instrument.

Caution: Environmental Conditions. Do not expose the instrument to temperature extremes. For proper operation, ambient temperatures should remain within the range listed in the **Specifications** section. Performance may be adversely affected if temperatures fluctuate above or below this range. Storage temperature limits are broader.

Caution: Sodium Hypochlorite. Do not expose any part of the instrument to the recommended diluted sodium hypochlorite solution (bleach) for more than 20 minutes. Prolonged contact may damage the instrument surfaces. Be certain to rinse and thoroughly wipe all surfaces.

Caution: Buffer Solution. Although many precautions have been taken to ensure that the instrument is as corrosion-proof as possible, the instrument is not sealed and liquids can seep into sensitive components. Make sure that any spilled buffer solution is wiped off the instrument. Prolonged exposure to salt solution may corrode parts of the microplate carrier, movement rail, springs,

and other hardware.

Caution: Chemical Compatibility. Some chemicals may cause irreparable damage to the instrument. The following chemicals have been deemed safe for use in the instrument: buffer solutions (such as PBS), saline, surfactants, deionized water, 70% ethyl, isopropyl, or methyl alcohol, 40% formaldehyde, and 20% sodium hydroxide. Never use acetic acid, DMSO, or other organic solvents. These chemicals may cause severe damage to the instrument. Contact BioTek for more information and prior to using other questionable chemicals.

Caution: Bovine Serum Albumin. Solutions containing proteins, such as bovine serum albumin (BSA), will compromise the instrument's performance over time unless a strict maintenance protocol is adhered to. See **Maintenance** procedures regarding BSA.

Caution: Power Supply. Only use the power supply shipped with the instrument. Operate this power supply within the range of line voltages listed on it.

Caution: Disposal. This instrument contains printed circuit boards and wiring with lead solder. Dispose of the instrument according to Directive 2002/96/EC, "on waste electrical and electronic equipment (WEEE)," or local ordinances.

Caution: Warranty. Failure to follow preventive maintenance protocols may void the warranty.

Caution: Shipping Hardware. All shipping hardware (e.g., shipping bracket etc.) must be removed before operating the instrument and reinstalled before repackaging the instrument for shipment.

Caution: High Flow Pump Installation. DO NOT plug the High Flow vacuum pump cable into a wall outlet! Use the adapter provided with the pump to connect the pump to the accessory outlet on the back of the washer. See the **Installation** instructions.

Caution: Waste Sensor Port on 405 LS. (For customers who have purchased the BioStack Microplate Stacker.) Although the waste sensor port on the back of the 405 LS is the same type as the 24-VDC power connector on the back of the BioStack, if an external 24-VDC power supply is plugged into the 405 LS's port, **it will permanently damage internal components.**

Caution: Electromagnetic Environment. Per IEC 61326-2-6 it is the user's responsibility to ensure that a compatible electromagnetic environment for this instrument is provided and maintained in order that the device will perform as intended.

Caution: Electromagnetic Compatibility. Do not use this device in close proximity to sources of strong electromagnetic radiation (e.g., unshielded intentional RF sources), because these may interfere with the proper operation.

CE Mark

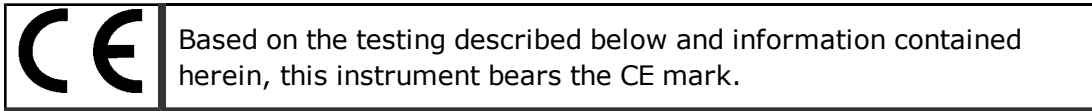

■ **Note:** See the Declaration of Conformity for specific information.

Directive 2004/108/EC: Electromagnetic Compatibility

Emissions—Class A

The system has been type-tested by an independent, accredited testing laboratory and found to meet the requirements of EN 61326-1: Class A for Radiated Emissions and Line Conducted Emissions.

Verification of compliance was conducted to the limits and methods of EN 55011 (CISPR 11) Class A. In a domestic environment it may cause radio interference, in which case, you may need to mitigate the interference.

Immunity

The system has been type-tested by an independent, accredited testing laboratory and found to meet the requirements of EN 61326-1 and EN 61326-2-6 for Immunity. Verification of compliance was conducted to the limits and methods of the following:

EN 61000-4-2, Electrostatic Discharge

EN 61000-4-3, Radiated EM Fields

EN 61000-4-4, Electrical Fast Transient/Burst

EN 61000-4-5, Surge Immunity

EN 61000-4-6, Conducted Disturbances from RFI

EN 61000-4-8 Power Frequency Magnetic Field Immunity Test

EN 61000-4-11, Voltage Dips, Short Interruptions and Variations

Directive 2006/95/EC Low Voltage (Safety)

The system has been type-tested by an independent testing laboratory and was found to meet the requirements of this Directive. Verification of compliance was conducted to the limits and methods of the following:

EN 61010-1, "Safety requirement for electrical equipment for measurement, control and laboratory use. Part 1, General requirements."

Directive 2002/96/EC: Waste Electrical and Electronic Equipment

Disposal Notice: This instrument contains printed circuit boards and wiring with lead solder. Dispose of the instrument according to Directive 2002/96/EC, "on waste electrical and electronic equipment (WEEE)" or local ordinances.

Directive 98/79/EC: In Vitro Diagnostics (if labeled for this use)

- Product registration with competent authorities.
- Traceability to the U.S. National Institute of Standards and Technology (NIST).

EN 61010-2-101 Particular requirements for in vitro diagnostic (IVD) medical equipment.

Electromagnetic Interference and Susceptibility

USA FCC CLASS A

RADIO AND TELEVISION INTERFERENCE

NOTE: This equipment has been tested and found to comply with the limits for a Class A digital device, pursuant to Part 15 of the FCC Rules. These limits are designed to provide reasonable protection against harmful interference when the equipment is operated in a commercial environment. This equipment generates, uses, and can radiate radio frequency energy and, if not installed and used in accordance with the instruction manual, may cause harmful interference to radio communications. Operation of this equipment in a residential area is likely to cause harmful interference, in which case the user will be required to correct the interference at their own expense.

In order to maintain compliance with FCC regulations shielded cables must be used with this equipment. Operation with non-approved equipment or

unshielded cables is likely to result in interference to radio and television reception.

Canadian Department of Communications Class A

This digital apparatus does not exceed Class A limits for radio emissions from digital apparatus set out in the Radio Interference Regulations of the Canadian Department of Communications.

Le present appareil numerique n'émet pas de bruits radioelectriques dépassant les limites applicables aux appareils numerique de la Class A prescrites dans le Reglement sur le brouillage radioelectrique edicte par le ministere des Communications du Canada.















User Safety

This device has been type-tested by an independent laboratory and found to meet the requirements of the following:

- **Underwriters Laboratories UL 61010-1** "Safety requirements for electrical equipment for measurement, control and laboratory use; Part 1: general requirements."
- **Canadian Standards Association CAN/CSA C22.2 No. 61010-1** "Safety requirements for electrical equipment for measurement, control and laboratory use; Part 1: general requirements."
- EN 61010 Standards, see CE Mark on page xiv.

Safety Symbols

Some of these symbols appear on the instrument or accessories:

	Alternating current Courant alternatif Wechselstrom Corrientealterna Correntealternata		Both direct and alternating current Courant continu et courant alternatif Gleich - und Wechselstrom Corriente continua y corrientealterna Corrente continua e correntealternata
	Direct current Courant continu Gleichstrom Corriente continua Corrente continua		Earth ground terminal Borne de terre Erde (Betriebserde) Borne de tierra Terra (difunzionamento)
	On (Supply) Marche (alimentation) Ein (VerbindungmitdemNetz) Conectado Chiuso		Protective conductor terminal Borne de terre de protection Schutzleiteranschluss Borne de tierra de protección Terra diprotezione
	Off (Supply) Arrêt (alimentation) Aus (TrennungvomNetz) Desconectado Aperto (scon- nessionedallaretedialimentazione)		Caution (refer to accompanying documents) Attention (voir documents d'accompagnement) AchtungsieheBegleitpapiere Atención (vease los documentosincluidos) Attenzione, consultare la doc annessa
	Warning, risk of electric shock Attention, risque de choc électrique Gefährlicheelektrischeschlag Precaución, riesgo de sacudidaeléctrica Attenzione, rischiodiscossaelettrica	 	Warning, risk of crushing or pinching Attention, risqued'écrasement et pincement Warnen, Gefahr des Zerquetschens und Klemmen Precaución, riesgo del machacamiento y sección Attenzione, rischiodischiacciareedintrappolarsi
	Warning, hot surface Attention, surface chaude Warnen, heiÙeOberfläche Precaución, superficiecaliente Attenzione, superficiecalda		Warning, potential biohazards Attention, risquesbiologiquespotentiels Warnung! MoeglichebiologischeGiftstoffe Atención, riesgosbiológicos Attenzione, rischiobiologico
	In vitro diagnostic medical device Dispositif médical de diagnostic in vitro Medizinisches In-Vitro-Diagnostikum Dispositivo médico de diagnóstico in vitro Dispositivo medico diagnostico in		Separate collection for electrical and electronic equipment Les équipements électriques et électroniques font l'objet d'une collecte sélective Getrennte Sammlung von Elektro- und Elektronikgeräten

	vitro		Recogida selectiva de aparatos eléctricos y electrónicos Raccolta separata delle apparecchiature elettriche ed elettroniche
	Consult instructions for use Consulter la notice d'emploi Gebrauchsanweisung beachten Consultar las instrucciones de uso Consultare le istruzioni per uso		

Introduction

Thank you for purchasing the 405™ Microplate Washer LS. This chapter describes the instrument's features and specifications and includes important contact information.

Introducing the 405™ Microplate Washer LS	2
BioStack Compatibility	3
Package Contents	5
Optional Accessories	7
Physical Specifications	9
Performance Specifications	10
BioTek's Customer Resource Center	12

Introducing the 405™ Microplate Washer LS

Let's get started by identifying the main components of the 405 LS microplate washer:



	Component	Description
1	Washer manifold	96- or 192-tube devices to aspirate and dispense fluid.
2	Priming trough and ultrasonic bath, when equipped.	Certain models support BioTek's patent-pending Ultrasonic Advantage™ ultrasonic cleaning of the wash manifold.
3	Microplate (Plate) Carrier	Holds standard microplates for processing and accommodates a magnet for biomagnetic-separation assays.*
4	Keypad	One of two ways to control the instrument; the other way is LHC.

*The special vacuum filtration carrier must be installed to perform filtration assays.

Instrument Models

A label on the side of the 405 LS identifies its model. BioTek distinguishes the variations between instrument models using this letter scheme:

R	"Standard" model to wash 96-well microplates. It has one manifold with 96 sets of dispense and aspirate tubes.
U	Dual-Action™ or "Select" models to wash 96- and 384-well plates. It has two sets of 96 dispense and aspirate tubes arranged in two manifolds that move independently of each other and support overflow wash and overfill protection for the most demanding assays.
HT	384-well microplate washer that is ideal for high throughput washing. It includes BioTek's patented Dual-Action manifold fitted with 192 aspirate and dispense tubes and allows overflow wash and overfill protection for the most demanding assays.
V	"V" models are equipped with Buffer Switching valves that support up to four separate reagents for complex assay requirements and to automate maintenance routines.
S	"S" models are equipped with BioTek's patent-pending Ultrasonic Advantage™ feature—a built-in ultrasonic cleaner (or sonicator) for enhanced maintenance of the manifold tubes. A stainless steel cleaning reservoir with an ultrasonic transducer bonded to its bottom is mounted on the washer.
Q	"Q" models are equipped with BioTek's Verify™ Clog Detection Technology that uses a liquid-level sensor to quickly detect clogs in the wash manifold's aspirate and dispense tubes. Requires BioTek's Liquid Handling Control™ (LHC) software.

BioStack Compatibility

The 405 LS is compatible with BioTek's BioStack Microplate Stacker. The BioStack can rapidly transfer microplates one-at-a-time to and from the instrument, and includes:

- Removable stacks (one input and one output).
- Optional restacking of plates to maintain correct sequencing.
- The ability to continue processing plates following the aborting/failure of one plate.
- The ability to pause processing to allow the user to add more plates to the input stack or to remove some from the output stack.

If you have purchased the BioStack to operate with the 405 LS, refer to the BioStack Operator's Manual for instructions on configuring the 405 LS to run with the BioStack. To help you get started: **[See Operating with the BioStack on page 81.](#)**

If you are interested in purchasing the BioStack, contact your local BioTek dealer for more information or visit our website at www.biotek.com.



Package Contents

- Part numbers and package contents are subject to change and vary according to instrument model. Please contact BioTek Customer Care if you have any questions.

Description	PN
Power cord (part numbers vary by country of use)	Varies
USB cable (USB Virtual COM Port Driver Software & instructions)	75108
Microplate carrier	Varies
Mist shield	1172017
Accessory kit	1170012
Stylus: for cleaning washer manifold aspirate tubes	7102108
Stylus: for cleaning washer manifold tubes	2872304
Stylus: for cleaning 192-tube dispense manifold	7102139
Shipping bracket - model dependent	7102138 1242018 or 1242021 1242032 and 1242019
Hex wrench: 9/64"	48434
Spare fuses (5)	46055
Verify Test Plate for "Q" models only	01588
Manifold Stop Screw Kit (Required for Vacuum Filtration, 384-Well PCR processing and magnetic bead assays.)	1170011
405™ LS Getting Started Guide (and Operator's Manual on CD - PN 11710015)	1171014

- Some components are model specific, they ship only with certain instrument models.

Waste and Dispense System Accessories

Part Number	Description	
Standard Vacuum Pump Systems:		
1170530	Complete Dispense/Waste System 115V/230V, 4L Bottles, including:	
	7100746	Waste: 4L bottles (2, one with sensor)
	1170529	Dispense: 4L bottles with filters (2)
7100746	Complete Waste System 115V/230V, 4L Bottles, including:	
	7100543	Waste: 4L bottles (2, one with sensor)
	7103024	Vacuum pump 115V/230V
1170535	Complete Dispense/Waste System 115V/230V, 10L Bottles, including:	
	1170534	Waste: 10L bottle (1), 4L bottle with sensor (1)
	1170528	Dispense: 10L bottles (2)
1170534	Complete Waste System 115V/230V, 10L Bottles, including:	
	7100582	Waste: 10L bottle (1), 4L bottle with sensor
	7103024	Vacuum pump 115V/230V
High Flow Vacuum Pump Systems:		
1170532	Complete Dispense/High Flow Waste System 115V/230V, 4L Bottles, including:	
	7100753	Waste: 4L bottles (2, one with sensor)
	1170529	Dispense: 4L bottles with filters (2)
7100753	Complete High Flow Waste System 115V/230V, 4L Bottles, including:	
	7100543	Waste: 4L bottles (2, one with sensor)
	7100754	High-flow vacuum pump 115V/230V
1170533	Complete Dispense/High Flow Waste System 115V/230V, 10L Bottles, including:	
	1170531	Waste: 10L bottle (1), 4L bottle with sensor
	1170528	Dispense: 10L bottles (2)
1170531	Complete High Flow Waste System 115V/230V, 10L Bottles, including:	

Part Number	Description	
	7100754	High-flow vacuum pump 115V/230V
	7100582	Waste: 10L bottle (1), 4L bottle with sensor (1)
Direct Drain Vacuum Pump Systems:		
1170536	Complete Dispense/Direct Drain Waste System 115V/230V, 4L Bottles, including:	
	1170529	Dispense: 4L bottles with filters (2)
		Direct drain vacuum pump & tubing
1170537	Complete Dispense/Direct Drain Waste System 115V/230V, 10L Bottles, including:	
	1170528	Dispense: 10L bottles with filters (2)
		Direct drain vacuum pump & tubing
Notes:		
1) Models with Buffer Switching receive a dispense system. Only a waste system must be ordered separately.		
2) High-flow waste system may be necessary for 384-well washing with buffers not containing surfactant.		
3) Direct Drain Waste System: use restricted to 96-tube single manifold models (i.e. 405 LS).		

Optional Accessories

- Part numbers and package contents are subject to change and vary according to instrument model. Please contact BioTek Customer Care if you have any questions.

General Instrument Accessories

Description		PN
BioTek liquid testing solutions for instrument qualification tests	Wetting Agent	7773002
	Blue Test Dye	7773001

Description	PN
Liquid Handling Control™ Software	LHC2
BioStack™ Microplate Stacker and integration kit	Biostack
Installation-Operational-Performance Qualification (IQ-OQ-PQ) package	1170543

Magnetic Bead Assay Accessories

Accessory	PN
Magnets:	
384-well Flat Magnet	7103017
384-well Ring Magnet	7102215
96-well Flat Magnet	7103016
96-well Ring Magnet	7102216

Vacuum Filtration Kit

Description	PN
-- 96-well Only	1170008
-- 96- and 384-well	1170009

Verify™ Technology Accessories

Description	PN
Verify Test Plate Replacement Kit	1240001

Miscellaneous Accessories

Description	PN
96-tube Manifold Kit - Replacement kit for 405 Select to support 384-well non-surfactant buffer washing (Tube-in-Tube).	1172046S
96-Tube 7-Degree Dual Manifold Upgrade Kit - Additional manifold for 405 HT for 96-well washing. (Tube-in-Tube)	1170010
4L Dispense Bottle w/filter	1173031
Cap for 4L Dispense Bottle w/filter	1173003

Description	PN
10L Dispense Bottle w/filter	1173000
Cap for 10L Dispense Bottle w/filter	1173002
Dispense Tubing Set - 1 Buffer	7100538
Dispense Tubing Set - 4 Buffers (For Buffer Switching models.)	7100537
4L Waste Bottle	7100534
Cap for Waste Bottle, 4L (Also fits 10L and 20L bottles.)	7100531
Waste Bottle with Level Sensing, 4L	7100542
Cap for Waste Bottle with Level Sensing, 4L	7100544
10L Waste Bottle and Tubing	7100557
20L Waste Bottle and Tubing	7100556
Waste Tubing Set	7100533
Vacuum Line Filter for Waste Tubing	48294
Vacuum Gauge/Regulator (For use with house vacuum.)	4030551
Silencing Muffler for Vacuum Pump (For use with P/N 7103024 pump.)	01113
Fluid filter for dispense bottles (does not include stainless steel adaptor 1172031)	01310

Physical Specifications

Labware	
Microplates	96-well, 384-well that comply with SBS microplate standards 1-2004, 2-2004, 3-2004, and 4-2004.
Microstrips	1 x 8, 1 x 12
Microwells	Flat, round, "V" bottom

Hardware & Environmental	
User Interface	2-line x 24 character LCD screen, 26 alphanumeric soft keys
Power Supply	The instrument uses two internal power supplies: 24-volt 60 watt and 48-volt 60 watt. These supplies are compatible with 100-240 V~; 50-

Hardware & Environmental	
	60 Hz.
Accessory Outlet	≤ 5.0 A, used for vacuum pump
Dimensions (W x D x H)	14 x 17 x 10 inches (36 cm x 43 cm x 25 cm)
Weight (≤)	32 lb (14.5 kg)/36 lb with Buffer Switching (16.3 kg)
Operating Conditions	10° - 40°C (50° - 104°F)
Relative Humidity	The instrument should be operated in a non-condensing humid environment having a maximum relative humidity of 80% at temperatures up to 31°C decreasing linearly to 50% relative humidity at 40°C.

Manifold Type	
96-tube	Single or Dual manifold with 96 sets of aspirate and dispense tubes arranged in an 8x12 array. Single manifolds can only process 96-well microplates; dual manifolds can process 96- and 384-well plates.
192-tube	Dual manifold with 192 sets of aspirate and dispense tubes arranged in a 16 x 12 array can only process 384-well plates.

Waste bottle volume	4, 10, or 20 liters, depending on the accessory package, (2 bottles, one with sensor)
Supply bottle volume	2 4L or 10L bottles (4 bottles w/ Buffer Switching)

Performance Specifications

Average Residual Volume (Evacuation Efficiency)	
96-Tube Manifold (Single and Dual)	Average residual volume in the microwells is ≤ 2 µL per well after a 3-cycle wash, when 300 µL of deionized water with 0.1% Tween 20®, or buffer equivalent, is dispensed per well into a Costar® 96-well flat-bottom plate. The aspirate height adjustment is optimized for the plate prior to testing.
192-Tube Manifold	Average residual volume in the microwells is ≤ 2 µL per well after a 3-cycle wash, when 100 µL of deionized water with 0.1% Tween 20, or buffer equivalent, is dispensed per well into a Costar 384-well flat-bottom plate. The aspirate height adjustment is optimized for the

Average Residual Volume (Evacuation Efficiency)	
	plate prior to testing.

Vacuum Filtration Evacuation Efficiency	
96-Well Filter Plates	Average increased weight of the plate is ≤ 1.2 grams after dispensing 300 μL of deionized water per well into a Millipore® MSHVN4450 96-well 0.45 μm plates (PN 98258) and vacuum aspirated for 30 seconds and blotted on a paper towel.
384-Well Filter Plates	Average increased weight of the plate is ≤ 4.0 grams after dispensing 80 μL of deionized water per well into a Millipore® MZFCN0W10 384-well 1.2 μm plates (PN 98287) and vacuum aspirated for 10 seconds and blotted on a paper towel.

Dispense Precision	
96-Tube Manifold	$\leq 3.0\%$ CV when dispensing 300 μL per well of deionized water with 0.1% Tween 20, with FD&C #1 blue dye at rate 6 into a Costar 96-well flat-bottomed plate. The absorbance of the solution is read at 630 nm and 450 nm reference.
192-Tube Manifold	$\leq 4.0\%$ CV when dispensing 80 μL per well of deionized water with 0.1% Tween 20, with FD&C #1 blue dye at rate 7 into a Costar 384-well flat-bottomed plate. The absorbance of the solution is read at 630 nm and 450 nm reference.

Verify™ Clog Detection Technology	
Timing	A Verify test shall be completed in less than 5 minutes from initiation until test results are displayed.
Performance	The Verify level sensor measurement shall have a repeatability standard deviation of $\sigma_{\text{measurement}} < 0.14$ mm (9.0 μL for 8X8 square well plate), where the $\sigma_{\text{measurement}}$ applies to a relative volume measurement, i.e. the delta between two volumes.

BioTek's Customer Resource Center

BioTek's Customer Resource Center (CRC) continues our tradition of superior service and support. After an easy registration process, you can access lots of useful information about your BioTek microplate instrumentation and software. On the secure CRC website, you can:

- Track orders
- Access warranty information, user manuals and software updates
- Download technical and application information
- Maintain equipment inventory (product registration)
- Request service and technical support
- View service history
- And much more!

Register at <https://customer.biotek.com>

Installation

This chapter provides detailed installation instructions.

Unpack and Inspect the Instrument	14
Remove the Shipping Hardware	14
Setting Up the 405 LS	18
Install Software/Connect to Computer	25
Connect to Power	26
Define Instrument Settings	26
Verify Performance	29
Repacking the 405 Washer	32

Unpack and Inspect the Instrument

Important: Save all packaging materials. If you need to ship the instrument or accessories to BioTek for repair or replacement, you must use the original packaging. Using other forms of commercially available packaging is not recommended and can void the warranty. Improper packaging that results in damage to the instrument may lead to additional charges. Refer to the operator's manual for repacking instructions.

Inspect the shipping box, packaging, instrument, and accessories for signs of damage.

If the 405™ Microplate Washer LS is damaged, notify the carrier and your BioTek representative. Keep the shipping cartons and packing material for the carrier's inspection. BioTek will arrange for repair or replacement of your instrument immediately, before the shipping-related claim is settled.

1. Unpack the boxes containing the instrument and other equipment:
 - 405™ Microplate Washer LS and accessories
 - Vacuum Pump and accessories
 - Vacuum Filtration Accessory Kit
2. Place all packing materials back into the shipping boxes for reuse if necessary.

Refer to the Package Contents on page 5 to make sure you have all expected equipment.

Remove the Shipping Hardware

The 405 LS is shipped with a protective manifold shipping bracket. Remove this bracket before using the washer and reinstall it prior to shipping to avoid irreparable damage to the manifold. Failure to remove and reinstall the shipping bracket may void your warranty.

Keep in mind that you must reinstall the shipping hardware and use the original shipping material if it is necessary to return the instrument to BioTek for service or repair.

Remove the manifold shipping bracket

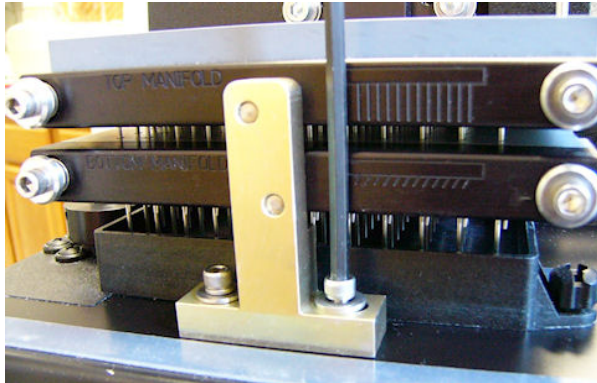

1. Use the 9/64" (3.57 mm) hex wrench to unscrew the cap screws at the base of the shipping bracket and remove it.
2. Slide the bracket towards you and remove.

- Most brackets are black, unlike the one shown here.

3. Store the bracket: mount it on the back panel, on the studs provided.

- Direct Drain Waste System: if you are using the direct drain waste method, wait till later to mount the shipping bracket. For direct drain, an intermediate collection bottle is attached to the washer using the same studs as the shipping bracket. See the Direct Drain Kit instructions.



405 LS with Verify™ Technology

"Q" Models

"Q" Models have three shipping brackets: remove two before powering up, and the last one after start up.

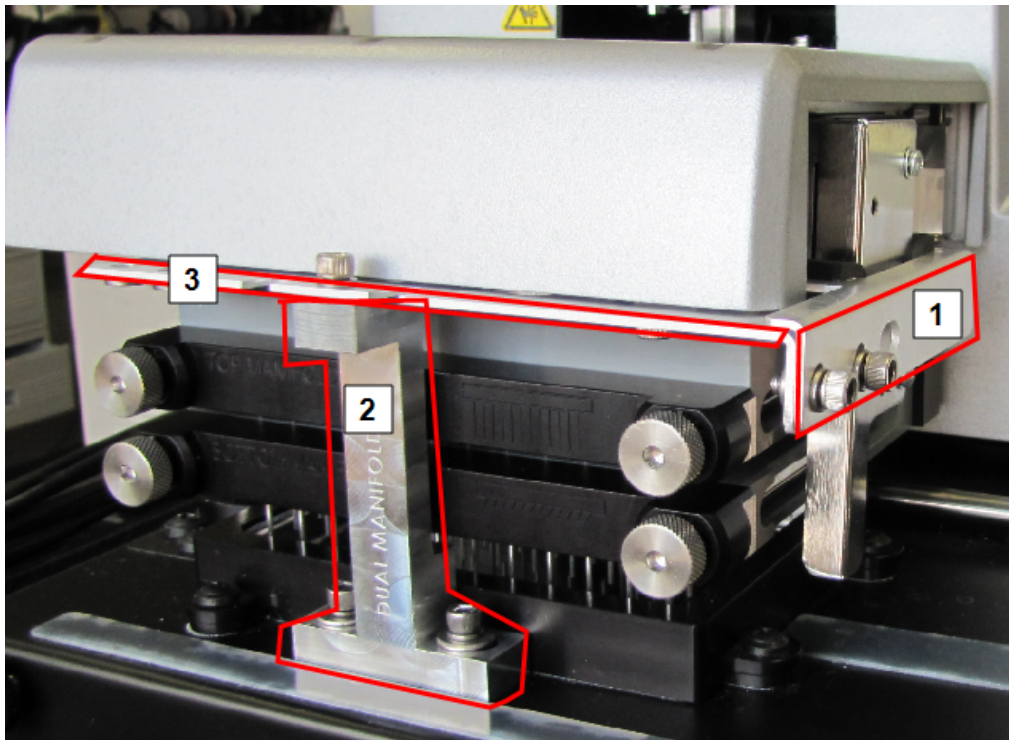

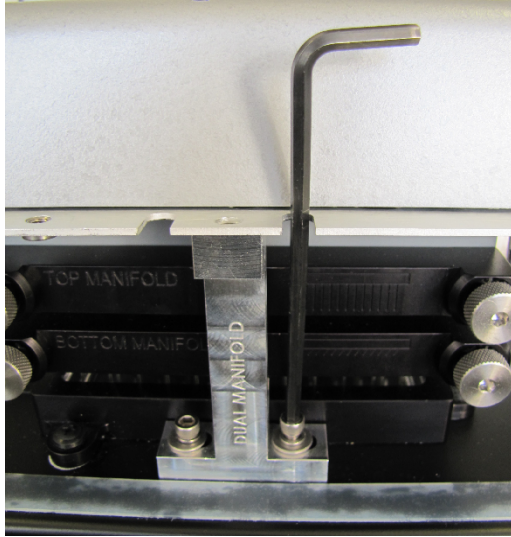

1. Use the 9/64" hex wrench to unscrew the cap screws and remove the bracket on the side of the wash manifold that holds the Verify sensor in place.
2. Remove the large bracket in front holding the wash manifold: Remove the three screws. Slightly lift the manifold(s) to release the bracket from the base, and pull it away from the manifold(s).
3. Set the brackets, screws and washers aside.

Follow instructions to set up the washer, e.g. install the vacuum pump and tubing. Then, perform Step 4, below.

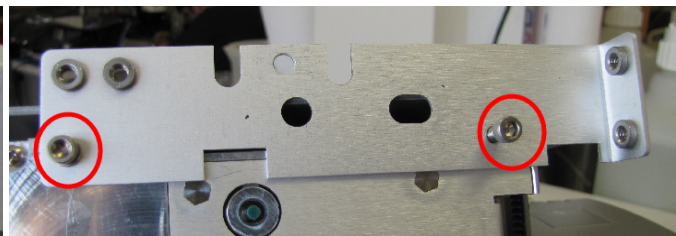
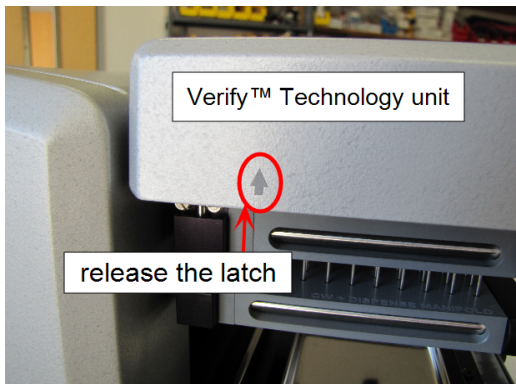

4. When you're ready to power up the instrument, plug it in and turn it on. Release the latch on the left side of the Verify™ sensor unit, and to lift it up to remove the third shipping bracket.
5. For safe keeping, put the cap screws and washers for the two thin brackets in the studs provided on the longest, last-removed bracket.
6. Put the manifold bracket's top screw back in its hole. Save the two longer screws for storing all the brackets on the back of the instrument.

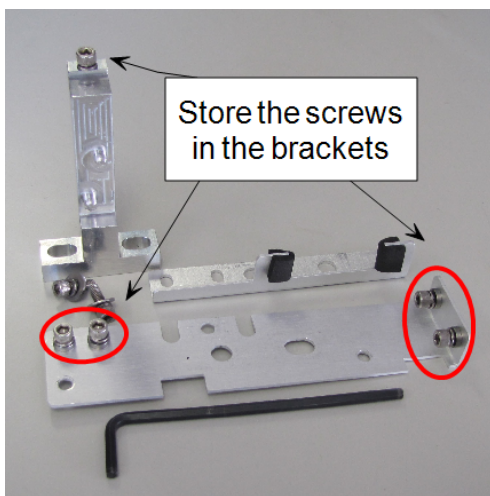



Layer the brackets on top of each other on the studs on the back.

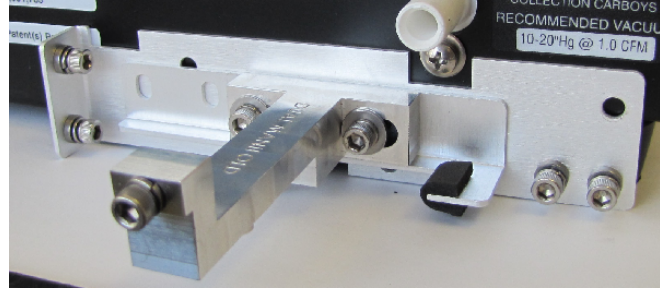

7. Store the brackets: mount them on the back panel on the studs provided. Beginning with the longest (3rd) bracket, layer the brackets on top of each other, and use the longest screws to secure them in place.

Setting Up the 405 LS

Important: Avoid **excessive humidity**. Condensation directly on the sensitive electronic circuits can cause the instrument to fail internal self checks.

Install the instrument on a level, stable surface in an area where ambient temperatures between 10°C (50°F) and 40°C (104°F) can be maintained.

The instrument should be operated in a non-condensing humid environment having a maximum relative humidity of 80% at temperatures up to 31°C decreasing linearly to 50% relative humidity at 40°C.

Install the Microplate Carrier

- Make sure the serial number on the underside of the plate carrier matches the washer's serial number. If the numbers do not match, call BioTek TAC immediately.

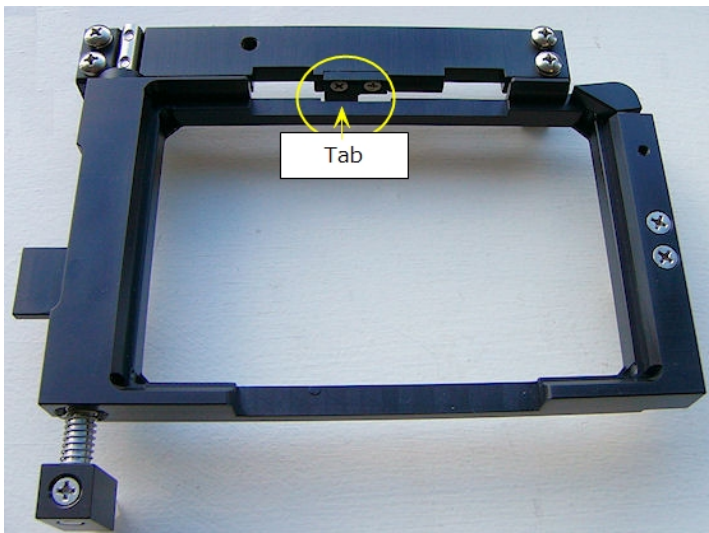

1. Line up the tab on the underside of the carrier with the slot on the carrier transport block.
2. Put the two carrier rail guides onto the transport rail. The tab should sit in the slot.

Connect the Vacuum Pump, Tubes, and Bottles

For optimal operation of the 405 LS, all tubing, cables, and fittings for the fluid supply and waste systems must be properly connected. This image illustrates

the rear panel of the instrument and the locations of the ports and connections for the fluid supply and waste systems.

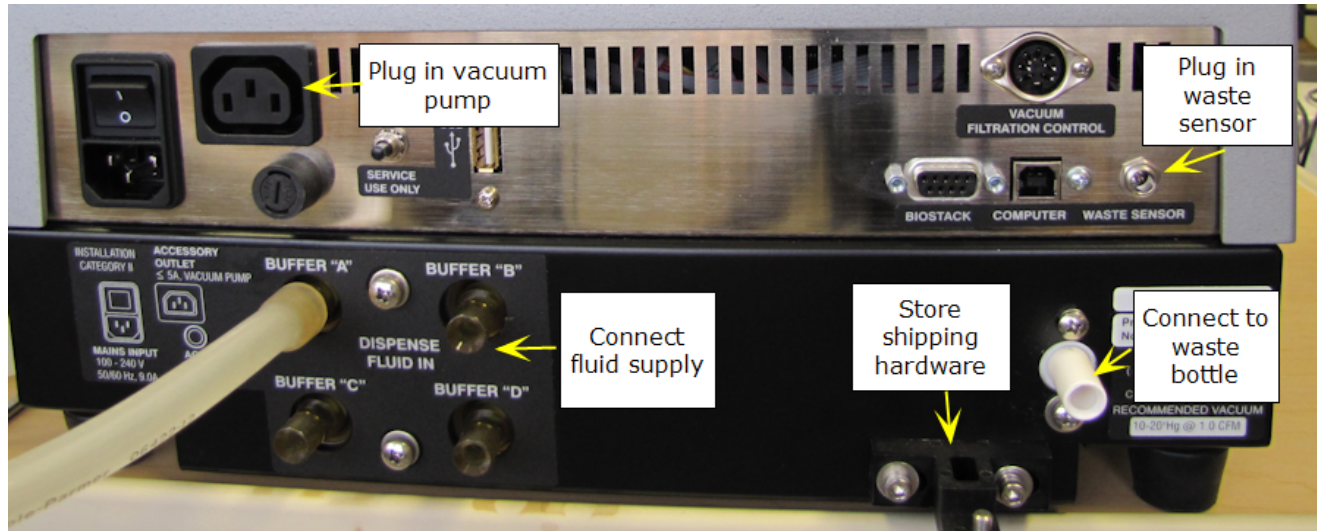

Rear Panel

Waste System

- ⚠ **Caution! Pump Installation. Do not** plug the vacuum pump cable into a wall outlet! Use the adapter provided with the pump to connect it to the **Accessory Outlet** on the back of the instrument. This allows the 405 LS to regulate the pump, turning it on and off as specified by the protocol.
- ⚠ When using a standard pump (rather than the high flow pump), set the instrument's **Vacuum Dissipation Delay** to prevent the pump from drawing excess current and blowing the 5-amp fuse. **See [Define Instrument Settings](#) on page 26**

■ **Note:** The waste tubes have colored bands that match similarly colored dots next to the inlet/outlet ports on the waste bottle caps to ensure the correct connection of the tubing.

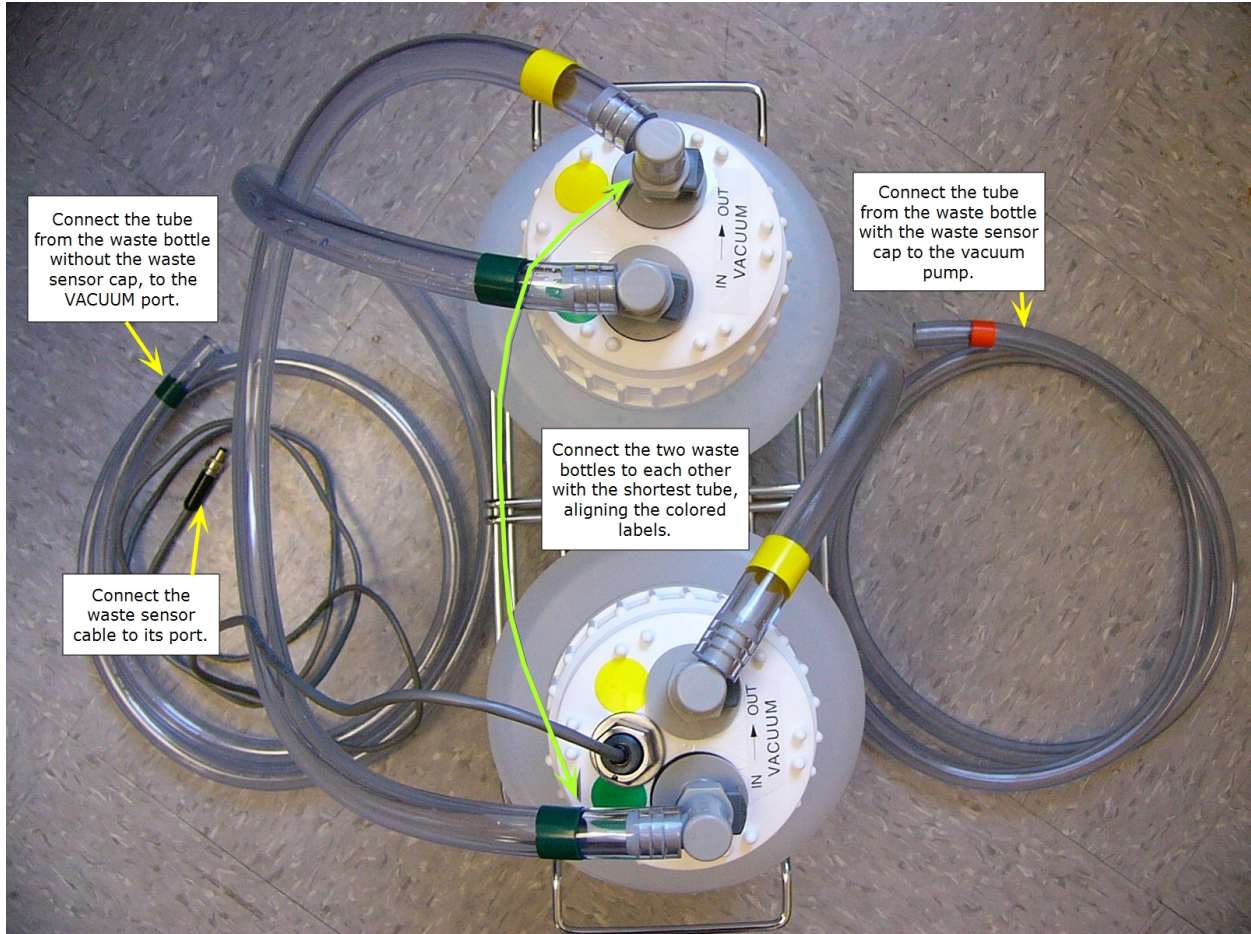

Waste System

Three lengths of tubing are shipped with the waste module:

Tubing:

- Short tube with yellow and green bands
- Long tube with green bands on both ends
- Long tube with yellow and orange bands

Connects:

- The two waste bottles to each other
- Bottle without sensor to vacuum **port**
- Bottle with waste sensor to the vacuum **pump**

1. Locate the quick-release caps shipped inside the waste bottles and attach the tubing to them as follows:
2. Connect the waste bottles to each other using the shortest length of tubing, matching the colored bands on the tubing to colored dots on the caps.
3. Attach the waste sensor cable to the **Waste Sensor** port on the back of the washer.
4. Attach the tube from the **waste bottle with the waste sensor** in its cap to the vacuum pump.

5. Attach the tube from the **waste bottle that does NOT have the waste sensor** in its cap to the **Vacuum** port on the back of the instrument.
6. **Important!** When installing BioTek's vacuum pump, connect the pump's AC power cable to the vacuum pump **Accessory Outlet** on the back of the instrument (Use the accessory outlet adapter provided, if applicable.)
7. Place the waste bottles and vacuum pump on the same horizontal plane as the instrument or below it, such as the floor beneath the work surface. This will help optimize performance.
8. Make sure the waste bottle's caps are well sealed.

■ BioTek strongly recommends installing the vacuum line filter to protect your vacuum pump.

Install the Vacuum Line Filter

The optional vacuum line filter (PN 48294) can be installed halfway between the last waste bottle (overflow bottle) and the vacuum pump.

To do this, cut the tubing and insert the filter, noting the direction of flow. The flow arrow on the filter should point **toward the vacuum pump**.

In the event of a fluid overflow, the filter should prevent the destruction of the vacuum pump's internal components. If an overflow does occur, check the filter for trapped fluid. If fluid is found in the filter, remove the filter and drain using the small white nut on top of the filter. Tighten the white nut and reinstall the filter.

Install the Fluid Supply System

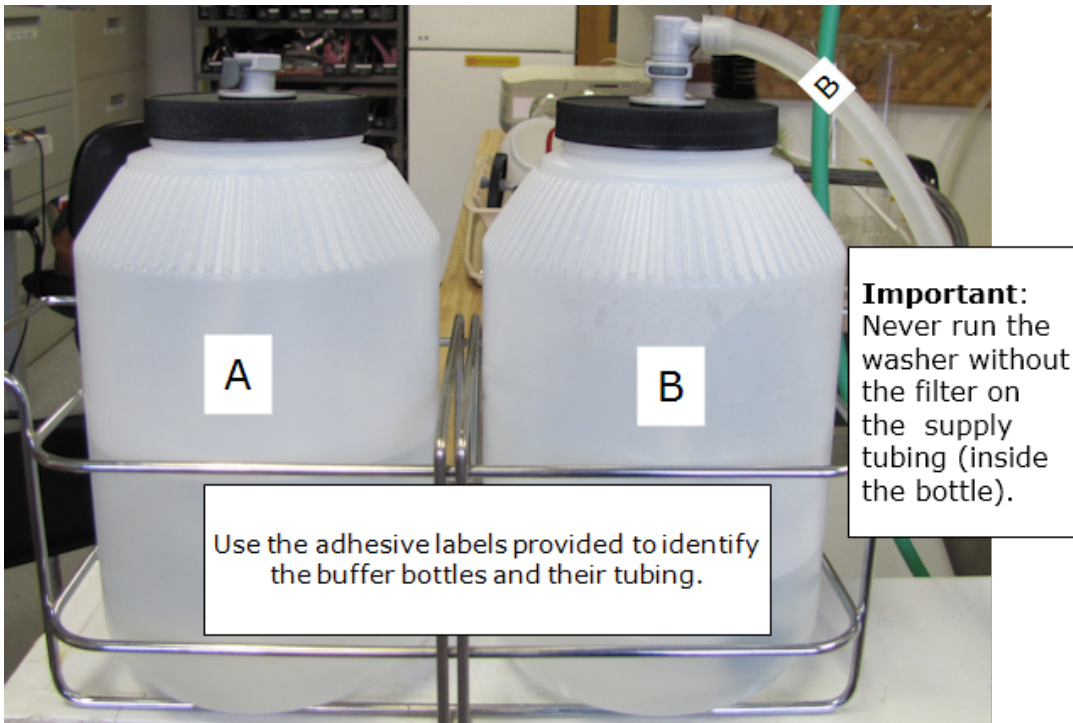

Prepare the supply bottles and tubing:

1. Remove the **Quick Release Connector** from its bag inside the supply bottle and connect it to the raw supply tubing provided.
 - You may need to cut the tubing to the desired length.
2. Snap the connector into the top of the supply bottle.



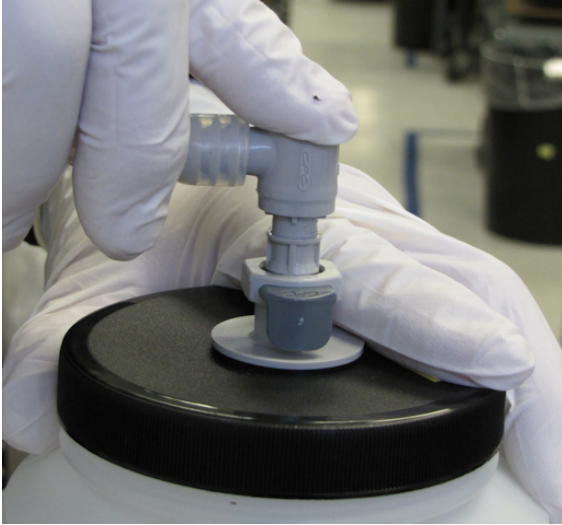

Make sure you hear the connector click!

Attach the labels provided with the washer to identify the buffer bottles.

Note: To avoid spilling fluid when refilling bottles or changing reagents, first release the Quick Connector from the bottle cap, use a paper towel to sop up the few drops in the cap. Then, refill the bottle.

With Buffer Switching (4 Buffers):

1. Place the four supply bottles on the same surface as the instrument.
2. Connect the tubing from one of the supply bottles to the "A" port on the back of the washer.
3. Repeat step 2 with the other three supply bottles for "B," "C," and "D" Buffers.



Without Buffer Switching (1 Buffer)

1. Place the supply bottle(s) on the same horizontal plane as the instrument.
2. Connect one the tubes to the **Dispense Fluid In** port.

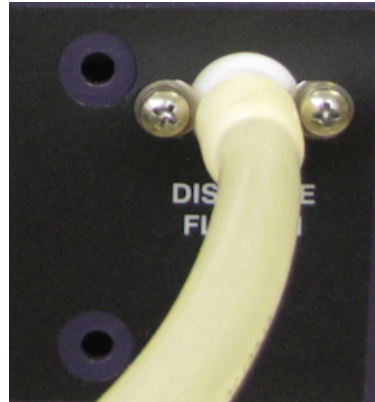

Final Check

- Verify that the tubing was not crimped during installation.
- Ensure that there are no loose fittings or cable connections.

Attach the Mist Shield

1. Position the mist shield so the gaps align with the thumbscrews. The top rests on the two rubber pads above the manifold.

 Always lift the mist shield straight up, **not** towards you, when removing it.

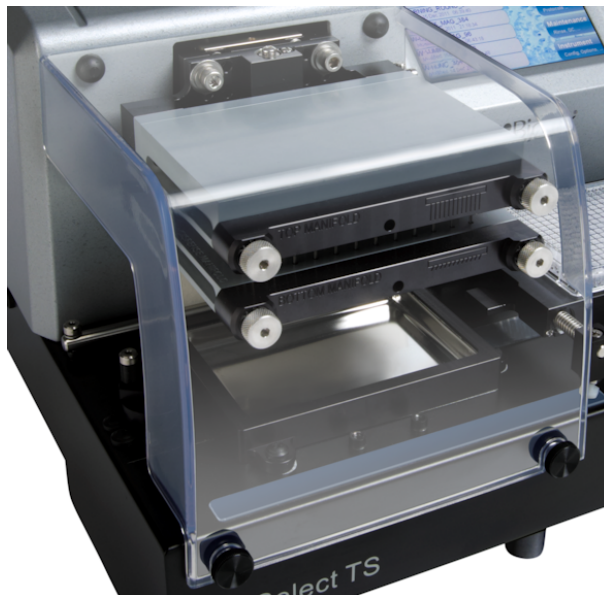

405 LSs equipped with Verify™ Clog Detection Technology ("Q" models) have a smaller mist shield.

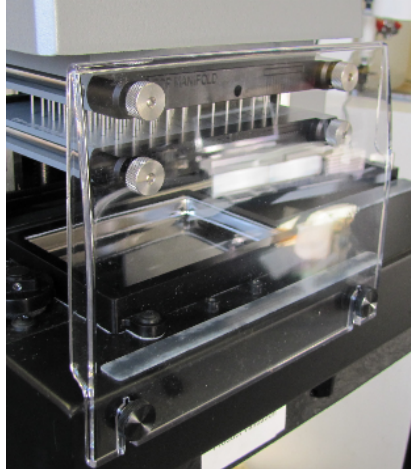

Install Software/Connect to Computer

If you purchased BioTek's Liquid Handling Control™ (LHC) Software to control the 405 LS using your personal computer (PC), please refer to the LHC Installation Guide for complete installation and setup instructions.

Connect to Host Computer

Using the USB cable: Plug one end into the **USB** port labeled **Computer** on the instrument and the other end into an available port on the computer.

- If the computer is connected to the Internet, turn on the instrument. Let Windows® automatically locate and install the necessary USB drivers (follow the online instructions), if applicable or open the link below to download the drivers.
- Virtual Com Port (VCP) drivers for all Windows operating systems are available at <http://www.ftdichip.com/Drivers/VCP.htm>
- If the computer is NOT connected to the Internet, install the drivers using the supplied "Virtual USB Com Port" driver software CD.

- The keypad must be displaying its "Main Menu" for the LHC to communicate with the instrument.



Technical Note: Only one of the two communication ports (COM port) on the instrument can be used at a time. They cannot be used simultaneously. You can use USB to connect the 405 LS to the computer or the RS232 serial port to

connect to a BioStack or similar robotic device. But you cannot use both ports simultaneously, i.e. make sure only one cable is plugged in at a time.

Connect to Power

 **Warning! Power Rating.** The 405 LS must be connected to a power receptacle that provides voltage and current within the specified rating for the system. Use of an incompatible power receptacle may produce electrical shock and fire hazards.

 **Warning! Electrical Grounding.** Never use a two-prong plug adapter to connect primary power to the 405 LS. Use of a two-prong adapter disconnects the utility ground, creating a severe shock hazard. Always connect the system power cord directly to a three-prong receptacle with a functional ground.

The 405 LS supports voltage in the range of 100-240 V~ at 50-60 Hz.

1. Plug the power cable into the power cable socket in the rear panel of the 405 LS.
2. Insert the three-prong plug into an appropriate receptacle.

Define Instrument Settings

LHC Users Only



When using the LHC to control the 405 LS, an important first step is defining your instrument's settings. After installing the LHC, you can use the desktop icon or the Windows Start button to launch the LHC:



> **All Programs> BioTek> Liquid Handling Control**

1. Click the **Name** link on the main page and, if required, select the 405 LS.
2. Specify the COM **Port** used to connect the 405 LS to the computer (use the drop-down list to select the port) and click **Test Communication**.
 - o **Pass**: proceed to the next step.
 - o **Fail**: check the Com Port setting. See "About Com Ports" in the LHC Help.
3. In the **Target Instrument Settings** dialog that opens, click **Get actual settings now**, and click **OK**.

Standard Vacuum Pump Users

■ **Do not** perform this step when using the **High Flow** vacuum pump (PN 7100754). High flow pumps are recommended when aspirating 384-well plates with non-surfactant wash buffers (e.g., pure deionized or distilled water).



Perform this step **ONLY** if you are using the “standard” vacuum pump (PN 7103024): increase the **Vacuum Dissipate Delay** to match your waste container: 1 second per liter. For example, if you have a 10 L waste bottle, set the delay to 10 seconds.

Using the LHC	Using the Keypad
<ol style="list-style-type: none"> 1. Select Tools>Instrument Utilities. 2. Under General Settings, increase the Vacuum Dissipate Delay to match your waste container: 1 second per liter. 3. Click Send to download this new setting to the instrument. 4. Click Exit to return to the main screen. 	<ol style="list-style-type: none"> 1. Press Setup Menu. 2. → Select the arrow (for more options) then, ADVANC. 3. Select VACDIS. 4. Use the number pad to set the Vacuum Dissipate Delay to match your waste container: 1 second per liter. 5. Press Main Menu upon completion.

Define Startup Preferences (LHC users only)

You can save enormous time creating protocols by following these steps to define a **New Protocol** template and use it at startup.

Create a protocol template

1.  Click the **New** button or select **File>New**.
2. Click **Name**. Select the 405 LS and define its **Port** and **Settings**.
3. Optionally, select the **Plate Type**, fill in the text fields, and add any steps that you want all new protocols to include.
4.  Click **Save** and assign a unique name, e.g. Template.LHC.
5. Select **Tools>Preferences>New Protocol**.
6.  Select the button for **Protocol selected below to use as a template**.
7. Click **selected** and select the protocol you created as a template.

Define startup behavior:

8. After completing the steps above, select the [Startup Options](#) tab.
9. Select the button for **New Protocol**.
10. Click **OK** to save your new preferences.

Verify Performance

Before using the 405 LS for the first time, verify that it is operating properly.

- When using the LHC, make sure the 405 LS is connected to the PC and both are powered up.
- When running standalone, turn on the 405 LS.

Using the keypad:

1. Select **UTILS** at the main menu.
2. Select **TESTS > SLFCHK**.

Using the LHC:

1. Click the **Name** link on the main page and, if required, select the 405 LS.
2. Define the COM **Port** used to connect the 405 LS to the computer and **Test Communication**.
3. In the Target Instrument Settings dialog that opens, click **Get actual settings now**, and click **OK**.
4. Select **Tools>Instrument Utilities**
5. On the General Settings tab, click the Perform **Self-Check** link.

Test results:

- **Pass**: no error message is displayed.
- **Fail**: an error message is displayed. If this happens, note the error code and refer to Troubleshooting on page 180 to determine its cause. If the problem is something you can fix, turn off the instrument, fix the problem, and then turn the instrument back on. Otherwise, contact BioTek's Technical Assistance Center.

The Qualification Chapter in the operator's manual provides Installation and Operational Qualification procedures to perform after the instrument is installed and *before* the instrument is used in a laboratory environment.

■ **Note:** An **instrument qualification package** (PN 1170543) for the 405 LS is available for purchase from BioTek. The package contains thorough procedures for performing Installation Qualification, Operational Qualification and Performance Qualification (IQ/OQ/PQ) and preventive maintenance (PM). Extensive Checklists and Logbooks are included for recording results.

■ **Important!** Before operating the instrument, review Optimize Performance on page 39. The guidelines include necessary steps to perform before running a protocol, and issues to consider when creating or editing protocols.

Verify the Washer

1. Fill the washer's supply bottle (bottle "A" for buffer switching models) with approximately one liter of deionized water.

LHC	Keypad
<ol style="list-style-type: none"> 1. Select File > Open. 2. Open the 405 LS and the Prime and Maintenance Protocols folders. Open the applicable "Buffer" folder, and then open W-DAY_RINSE.LHC. You <i>may</i> need to reset the Com Port. 3. When ready, click the Run button to prime the tubing and manifold with deionized water. 4. When finished, close the program. 	<ol style="list-style-type: none"> 1. Select RUN at the main menu. 2. Scroll (press Options) to DAY_RINSE. Press ENTER to confirm selection of the protocol and press START to run the protocol. 3. When the protocol is completed, press Main Menu.

Run the Verify Test ("Q" Models Only)

If your 405 LS is equipped with BioTek's Verify™ Technology, run the test:

Important! Before running the test:

Make sure the 405 LS is primed and ready to run:

- Fully prime the tubing/system, e.g. run **Day Rinse**.
- If necessary, empty waste vessel and tighten waste bottle cap.

Prepare to run the Verify test:

- Fill the supply vessel with at least **100 mL** dH₂O or DI water or buffer solution¹.
- Put the Verify Test Plate on the standard-mag bead plate carrier (without a magnet)² in the proper orientation: "Front" label is readable (well A1 in the back, left of the carrier). See also: Handling the Verify Test Plate on page 73.

¹Do not use highly viscous fluids or wash buffers that are prone to leave significant residue on the plate.

²Vacuum filtration assays: You must uninstall the vacuum filtration plate carrier and install the standard-mag bead plate carrier to run the test. For this temporary purpose, you do not need to change the instrument's plate carrier setting to run the Verify test.

Run the Verify test:**LHC**

1. Select **Tools>Instrument Utilities>Verify Manifold** and click **Run** a new Test.

- **Buffer:** Select the bottle to use, if applicable.
- **Prime:** optionally, prime the manifold tubes to correct for evaporation loss. 40 mL of fluid is dispensed.
- **%CV Threshold:** optionally, change the %CV to match your lab's standard for QC tests: 5-15%. The default value of 5% is recommended.

2. Press **Start** to run the test.

3. Assess the results: Verify Results.

 Do not discard the **Verify Test Plate**. Reuse it for as long as possible. **See [Replacement Procedure for Verify Test Plate on page 134](#)** if it is damaged.

Contact BioTek TAC if any of the tests fail.

Repacking the 405 Washer

Prior to sending your instrument to us for repair, log into the Customer Resource Center (www.biotek.com) to submit a Service Request for a Return Material Authorization (RMA). Your instrument's serial number is needed to process an RMA.

- Failure to comply with the following instructions will void the instrument's warranty and result in additional charges if the instrument is damaged. If you have lost the original packing materials, contact BioTek TAC to order Part Number 1173009.

- Decontaminate the instrument before returning it: [See Decontamination on page 138.](#)

Step 1: Install the shipping bracket:

All models: Remove the shipping bracket(s) from the storage place on the back of the washer.

Verify™ Technology ("Q") models: With manifold in its home position, install the longest shipping bracket that secures the Verify sensor unit. Set aside the large manifold bracket and smaller sensor bracket for later installation:

1. Release the latch and raise the Verify sensor unit and install the longest bracket. Lower the Verify unit when finished.
2. Put the manifold in its "park" position:

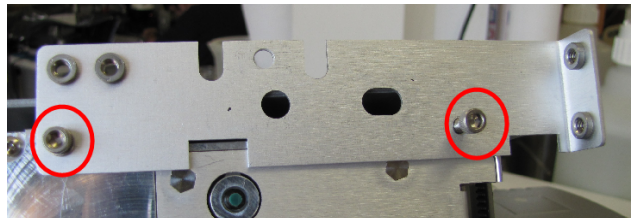

LHC	405 LS Keypad
<ol style="list-style-type: none"> 1. Select Tools>Instrument Utilities>Washer 2. Click the shipping bracket link under Service Functions. 	<ol style="list-style-type: none"> 1. Press Setup Menu. 2. Select WASH > PARK.

3. **"Q" models only:** Install the second, smaller bracket which covers the sensor on the side of the Verify unit. Then, proceed with the regular repacking instructions.

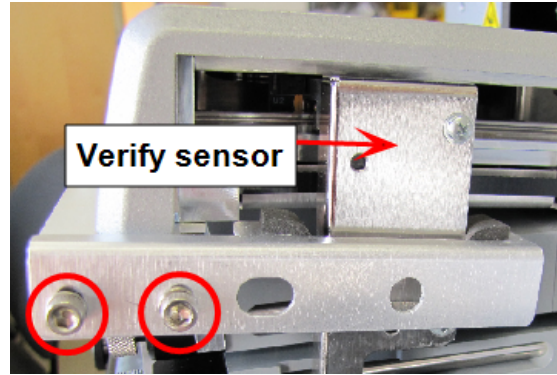

4. Install the manifold shipping bracket. "Q" models: secure the manifold bracket to the Verify unit bracket.
5. Remove the plate carrier and put it in the accessories box.
6. 405 Touch: Tape the cardboard protector on top of the touch screen.

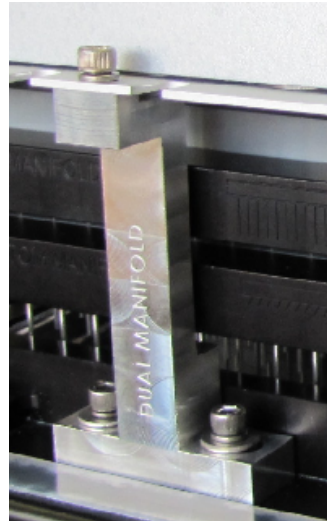

Obtain an RMA number:

- Contact BioTek TAC to obtain a Return Materials Authorization number,
- Write "RMA" on the shipping box in large, clear letters,
- And, include the RMA number in the shipping address label:

BioTek Instruments, Inc.

ATTN: RMA# xxxxx

15 Tigan Street

Winooski, Vermont 05404 USA

Step 2

After completing Step 1, installing the shipping hardware:

- Put the washer in the plastic bag.
- Seat the washer in the foam base in the inner box and slide it forward, pushing the manifold into the foam pockets.

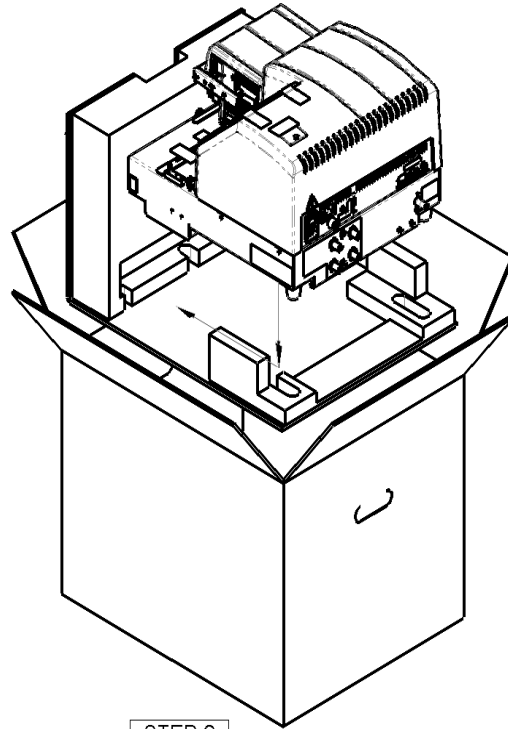

STEP 2

Step 3

Slide in the cardboard and foam shipping blocks (2) to cushion the washer on both sides.

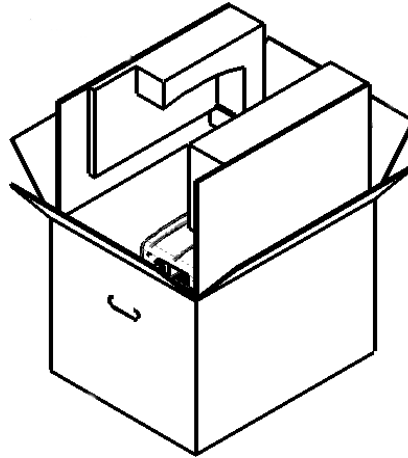

Step 4

Put the mist shield in the space provided.

Place the accessories in the shipping tray and put the tray on top of the washer in the inner box.

Tape the inner box closed.

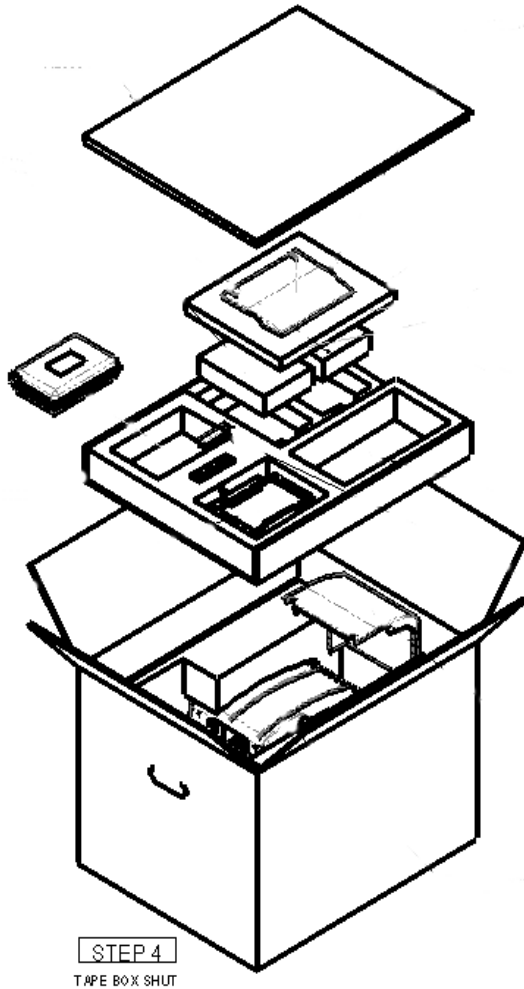

Step 5

Put the corner blocks on the inner shipping box and put it in the outer shipping box.

Tape the box closed.

In large letters, write "RMA" on the outer box and attach the shipping address label, including your assigned RMA number.

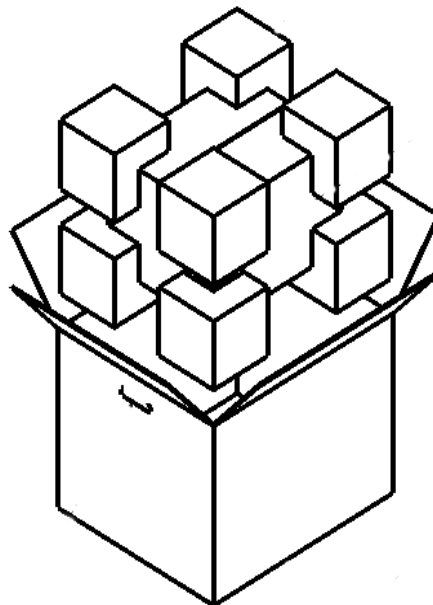

Operation

This chapter provides instructions for controlling the 405 LS.

Basic Operation	38
Optimize Performance	39
Predefined Protocols Listing	43
Predefined Sample Protocols	44
Introducing the 405 LS Keypad	46
Using LHC to Control the 405™ Washer	54
LHC Protocols	56
LHC Protocols Explained	57
Target Instrument Settings	58
Verify Performance	72
Configure Verify™ Technology Utilities	79
Operating with the BioStack	81
Cell Wash	84
Biomagnetic Separation - Magnetic Bead Assays	89
Manifold Stop Screw Adjustment Kit	94
Vacuum Filtration for Filter Plate Assays	97
Washer Settings	105
Adjust Utility	108
Plate Types and Processing Patterns	110

Basic Operation

Two ways to control the 405 LS

You can control the 405 LS using its built-in keypad or with BioTek's Liquid Handling Control™ (LHC) software.

To use the LHC to control the instrument, it must be attached to and communicating with your personal computer (PC), and its main menu must be displayed. Basic protocols can be created or modified using the LHC, and then downloaded to the instrument for stand-alone operation. Learn about transferring protocols from the LHC to the instrument in the LHC Help system: select the **Help** menu or click a **Help** button in a window.

- Find instructions for using the LHC beginning page 54.
- Keypad instructions begin on page 46.

Two ways to wash a plate

The 405 LS offers two ways to wash a plate:

- **Quick Wash:** using the keypad you can wash a plate by defining a few parameters like fluid volume and number of wash cycles and rely on default parameters for the more advanced options. [See Quick Wash \(Keypad only\) on page 47.](#)
- **Run a Wash Protocol:** using either the keypad or the LHC you can run a wash protocol to wash a plate. You can run a predefined protocol or define your own protocol to specify the optimal parameters for your assay. [See Running Predefined Protocols on page 41.](#)

About the 405 LS Wash Step

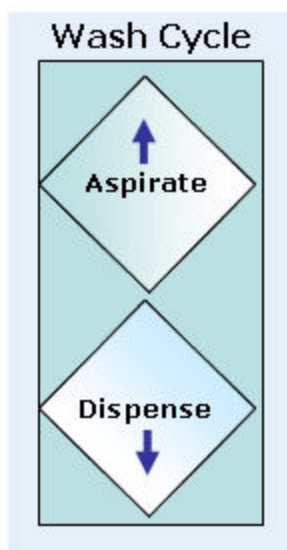

Minimally, a wash step includes an aspirate step followed by a dispense step. This is a **wash cycle**.

The default definition of a wash step includes 3 cycles, followed by a final aspiration to evacuate the wells.

It is important to prime the washer manifold before running a wash. You may also want to include a [Pre-dispense](#) or tip prime (over the priming trough) to correct for evaporation and other minor fluid loss to normalize the tips.

About the hardware: The 96- and 192-tube wash manifolds perform both steps, aspirating and dispensing fluid to and from 96-well and 384-well plates.

Optimize Performance

Here are some guidelines to ensure optimal performance and to prevent problems.

Keep the devices clean and the tubing wet

The most critical factor for ensuring optimal performance is to adhere to the Recommended Maintenance Schedule on page 119. Enable **AutoPrime** to keep tubes from clogging.

Prime the tubing to remove air bubbles

- [See 405 Recommendations for Priming the Washer below](#)

Best Practices

- Fill the supply bottles with sufficient fluid. Never run the 405 LS without the fluid filter installed (on the end of the tubing inside the supply bottle).
- **Note:** To avoid spilling fluid when refilling bottles or changing reagents, first release the Quick Connector from the bottle cap, use a paper towel to sop up the few drops in the cap. Then, refill the bottle.
- Make sure the bottles, solutions, and tubing are clean and do not contain any particles or mold. Solutions that are recycled over several days will grow algae, bacteria, molds, or other undesirable organisms.
- Prime before dispensing. Priming the tubing is the most critical factor in assuring optimal performance.
- Empty the waste bottles and firmly seat the bottles' caps and quick release connectors. To make sure fluid does not back up into the vacuum pump during operation keep the waste sensor cable installed and the waste detection sensor activated (see Sensors Enabled on page 1). If fluid collects in the overflow bottle, thoroughly rinse the fluid-level switch and bottle.
- Check the external tubing connections for kinks and clogs.
- When equipped with BioTek's Verify™ Technology ("Q" models), before processing your assay plates, take five minutes to run the Verify routine to ensure the manifold tubes are not clogged.
- Put microplates on the carrier with well A1 in the left rear corner as you face the instrument, and firmly seat the plate in the carrier.

405 Recommendations for Priming the Washer

These recommended prime volumes are required to achieve 95% or higher purity when changing wash buffers.

Model	Buffer Switching	One Buffer
405 TS/LS	300	250
HT	300	250

Buffer Switching models have four buffer valves; otherwise, only one reagent bottle may be connected to the washer. For Select models (with Cell Wash (CW) capability), the recommended prime volume is the same with and without Buffer Switching.

Model	Quick Prime	Prime step	
Select	300	Main	Low Flow
		150	150

Manifold Prime: 50 mL is recommended to clear air from the manifold only and to wet the tips. This is recommended before running a protocol to correct fluid loss due to evaporation.

Dead Volume

BioTek's recommended prime volumes are based on purity testing and measured dead volumes. Generally, priming with three times the dead volume assures purity.

Model	Dead Volume
405 TS/LS	108 mL
HT	108 mL
Select	129 mL

For models with buffer switching tubing, dead volume is ± 2 mL additionally.

Optimize protocols to improve evacuation

When a wash protocol leaves too much residual fluid in the wells, optimize the protocol with these recommendations:

- Add a secondary aspiration to a wash cycle on page 70, including [Final Aspirate](#),
- Decrease the aspirate [Travel Rate](#),
- Add a [Delay](#) to the Aspirate and/or Final Aspirate step ,
- Lower the aspirate height (Z-axis position).

Running Predefined Protocols

BioTek provides numerous predefined protocols for maintaining the instrument in top condition and for qualifying its performance. Review the **Predefined Protocols on page 43**.

To run a defined protocol:

LHC	Keypad
<ol style="list-style-type: none">  Select Open and locate the 405 LS folder. Open the 405 LS folder. Find the desired protocol for your instrument model. <p>Important: Be sure to Customize the Predefined Protocols below</p>	<ol style="list-style-type: none"> At the main menu, press RUN. Press Options to scroll to the desired protocol or use the arrow and number keys to enter its number. Press ENTER and follow the prompts.

Creating Protocols: Washing, Aspirating and Dispensing Fluid

In addition to the quick routines available from the keypad's main menu, you can define and run protocols. Protocols offer more parameters, giving you the ability to fine-tune instrument performance, and perform more complex processing.

Keypad Control



Find instructions for creating and modifying protocols using the keypad beginning page 48.

Liquid Handling Control™ (LHC) Software



Launch the LHC software to create or modify protocols, see page 54



Select Help>Help Topics to learn about the LHC.



LHC Users Only: Customize the Predefined Protocols

BioTek provides predefined protocols for maintenance routines and instrument qualification tests. You can quickly customize the protocols for regular use.

 The LHC keeps track of the last-used COM port for an instrument type. For example, when an EL406 runs a protocol, the LHC logs the COM port used and the next time an EL406 is used, the LHC applies the same COM port setting. You can disable this feature by defining your **Ports** preference: select **Tools>Preferences>Ports**.

To correct the COM port for the current protocol, click the **Port** link and use the drop-down list to select the correct value. The LHC stores the COM port value in the protocol file.

With the 405 LS connected to and communicating with the host computer (i.e. make sure the instrument is turned on and not busy):

1.  Click the **Open** button, locate the **405 LS** folder and click **Open**.
2. Open the **Maintenance** or other folder and select the desired protocol.
3. **Port:** Change the COM port if necessary: click **Port** and enter the correct value or select from the drop-down list.
4. **Settings:** Click **Settings**, which opens the Instrument Settings dialog.
5. Under **Get settings from:** click the **instrument** link.
6.  Click **Validate**.

A "Validation successful" message is displayed unless the protocol cannot be run on your instrument. See LHC Protocols Explained on page 57.

7.  Save the protocol.

Predefined Protocols Listing

LHC Users: Folders named 4Buffers and 1Buffer contain customized protocols for models with and without Buffer Switching, respectively.

Keypad Users: The protocol names onboard the washer do not include the W- prefix and some protocols include the model name, e.g. 405HT or 405Select, when appropriate.

Maintenance Protocols

Daily Maintenance	Description
W-DAY_RINSE	Simple one-step protocol to fully flush the system with water or reagent to keep the manifold tubes clog-free. Defined for use with Buffer A; 500 mL total volume.
W-OVERNIGHT_LOOP	Protocol designed to keep the manifold in a wetted condition overnight or for a long downtime period; manifold tubes are submerged in fluid for 4-hour intervals between primes in this virtually endless loop. Defined to use Buffer A.
W-RINSE_AND_SOAK	Identical to W-DAY_RINSE with one addition, the manifold tubes are submerged and soaked for 5 minutes in the fluid.

Periodic Maintenance	
W-Decontaminate DECON (onboard)_STEP1, STEP2, STEP3	Two/three stage protocol to decontaminate the washer, first flushing lines with disinfectant and then rinsing them with deionized or distilled water. Buffer switching models flush and then rinse all four lines. Manifold tubes are submerged and soaked for 20 minutes during each pass. Prompts guide the user through the process.
W-LONG_SHUTDOWN PURGE_WITH_AIR (onboard)	Helps implement the routine recommended for preparing the instrument for storage. This protocol includes prompts for running disinfectant from Buffer A, then water from Buffer B, and lastly, air through the system - remove bottle from Buffer C valve.
W-CLEAN (LHC Only)	Combines priming and AutoClean steps to clean and rinse the manifold. For units with the Buffer Switching module it is defined to obtain cleaning fluid from Buffer B, and rinse fluid from Buffer A. Units without Buffer Switching are prompted to change fluids.
W-PRIME_250/300	Simple prime routine; defined for Buffer valve A only. For LHC only.
PRIME_ALL_BUFFRS	Consecutively primes each of the Buffer Switching valves beginning with D. Designed for use in the annual instrument verification test of the Buffer Switching module.

QC (Quality Control) Protocols

Manifold-Specific	
QC_96_DISP_TEST	Dispense precision test protocol for 96-tube manifold.
QC_96_EVAC_TEST	Evacuation efficiency test protocol for 96-tube manifold.
QC_192_DISP_TEST	Dispense precision test protocol for 192-tube manifold.
QC_192_EVAC_TEST	Evacuation efficiency test protocol for 192-tube manifold.
QC_96_VAC30_TEST	Vacuum filtration evacuation efficiency test for 96-well filter plates and also recommended for use in maintenance procedures.
QC_384_VAC10_TEST	Vacuum filtration evacuation efficiency test for 384-well filter plates and also recommended for use in maintenance procedures.

Predefined Sample Protocols

The "Sample" protocols are provided to facilitate learning. Some samples are model specific.

Keypad Users: The protocol names onboard the washer do not include the W- prefix and some protocols include the model name, e.g. 405HT or 405Select, when appropriate.

LHC users: First open the folder that matches your washer model, e.g. 405 Select. You may need to customize the protocols (*as described on page 41*) to match your instrument's settings.

Cell Wash	
W-CELLWASH_96	Cell wash protocol designed to minimize cell layer disturbance in 96-well plates. Aspirate height increased to 50 steps (6.35 mm above plate carrier) resulting in increased residual, approximately 100 µL.
W-CELLWASH_384	Cell wash protocol designed to minimize disturbance to cells in 384-well plates. Aspirate height increased to 50 steps (6.35 mm above plate carrier) will cause increased residual volume but help to preserve the cell monolayer.
Microplate Manufacturers	
W-Corning_FLAT	Standard wash protocols modified to best position the manifold tubes for dispensing and aspirating to Corning Costar flat-bottomed and round-bottomed wells.
W-Corning_ROUND	

W-NUNC_384	Standard wash protocols modified to best position the manifold tubes for dispensing and aspirating to Nunc® flat-bottomed wells, round-bottomed wells, and 384-well plates.
W-NUNC_FLAT	
W-NUNC_ROUND	
Bead Assays - Biomagnetic Separation and Bottom Filtration	
W-Luminex_MAG_plate_96	Biomagnetic separation wash protocols designed for optimal bead recovery in 96-well round- or flat-bottomed plates and 384-well plates when using BioTek's Flat magnets. Begins by soaking the plate for 1 minute to let the beads settle at the bottom of the wells, then performs a 2 cycle wash with 30 second soaks between cycles. Recommendation: Determine Magnet Height Offset on page 93 and apply it for the plate you are using, especially when using 384-well plates.
W-Luminex_MAG_384	
W-Luminex_VAC_96	Vacuum filtration wash protocols for Luminex® xMap polystyrene bead assays using filter-bottom plates, 96- and 384-well. Protocol begins with a 5 second bottom aspiration, followed by a 200 µL dispense for 96-well plates and 75 µL dispense for 384-well, and a two cycle 200/75 µL wash.
W-Luminex_VAC_384	

Introducing the 405 LS Keypad

The keypad on the 405™ Microplate Washer LS features 26-keys and a 2 x 24-character LCD. The main menu is shown below.

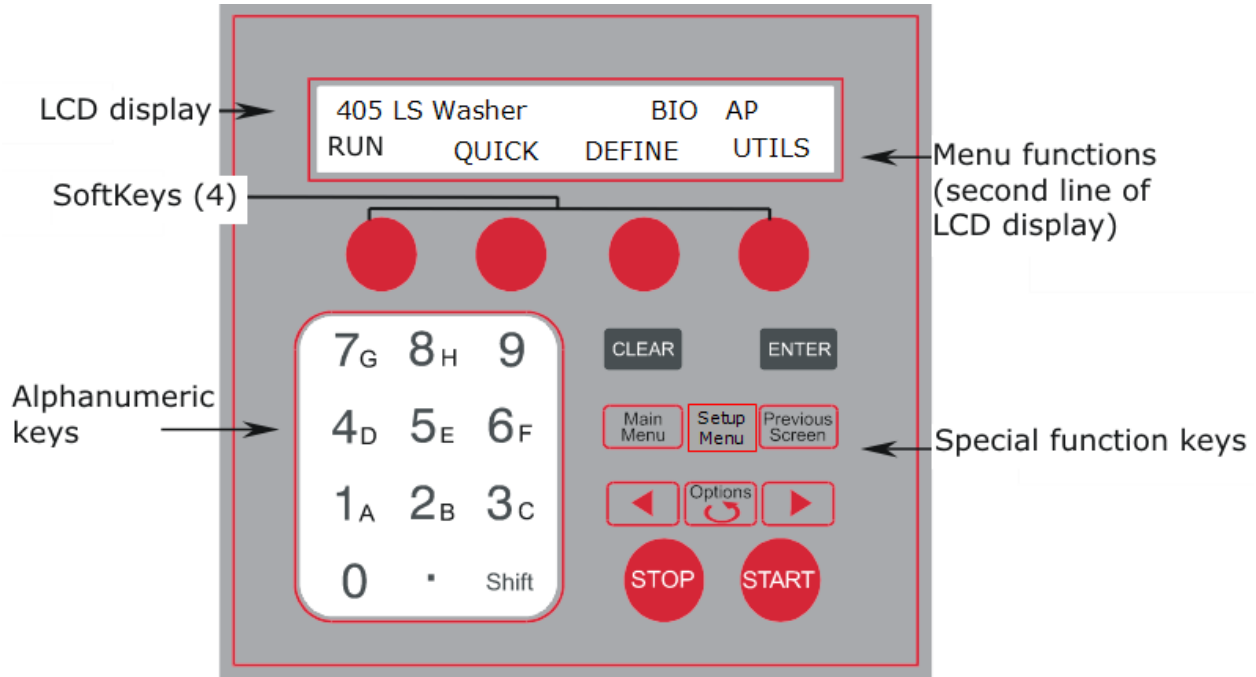

Starting at the top of the keypad, note the main menu and the **Soft-keys**. Use the Soft-keys to make selections. To return to the main menu, press the **Main Menu** key.

At the main menu, the top line displays **AP** when AutoPrime is enabled and **BIO** when the washer is set to interface with and control the BioStack.

- **RUN** - to run a previously defined protocol. Use the **Options** key to select a protocol or enter its number. [See **Predefined Protocols Listing on page 43**](#).
 - **Turn On/Turn Off the Vacuum Pump** to drain the priming trough. At the Quick menu:
 - Press Shift+1 to turn on the vacuum pump.
 - Press Shift+2 to turn off the vacuum pump.
 - Use these key sequences to manually control the vacuum pump when dispensing fluid. At times the priming trough fills up and is not emptied automatically. This option gives you control in that situation.
- **QUICK** - leads to simplified wash, prime and Ultrasonic Advanatage™ options.

- **DEFINE** – leads to the protocol creation and editing mode: Create or Edit a Protocol on next page.
- **UTILS** – to run system tests, the Adjust Utility, and to define AutoPrime parameters.
- **Setup Menu**: press this key to access the instrument’s general settings and the settings for the BioStack.
- The **Options** key (and sometimes the arrow keys) scroll through the available options or settings for the current focus. Shift+Options reverses the scrolling direction.

Quick Wash (Keypad only)

Select **QUICK>WASH** at the main menu to perform a quick wash.

96	WASH:003	VOL:0300 A
PLATE	CYCLE	BUFFER

Quick Wash Menu

■ Only options applicable to your model are displayed.

- **96** in the above example is the plate type. Select **PLATE** to change it; scroll through the compatible choices for plate washing with the currently installed hardware and press **Enter** to select the desired plate.
- **WASH:003** is the number of wash cycles (one aspirate and dispense step per cycle). Select **CYCLE** to change the number of cycles to perform.
- **VOL:0300 uL** shows the dispense volume per well in microliters.



To change the dispense volume, use the arrow keys to move the cursor to the desired number position. The cursor appears to underline a number: 0010. When the correct position is selected, use the number pad to enter the desired value. Or, press Options to increment the value, Shift+Options to decrease the value.

- **Buffer** is offered on washers with Buffer Switching to select the buffer valve. The current selection is displayed in the top right corner of the LCD.
- **PLATE** lets you change the selected plate type and define a partial plate run, if applicable. [See Define the Plate Type and Plate Map \(or Partial Plate\) on page 50.](#)



When the desired values are entered, put a plate on the carrier and press **Start** to run the routine.

If Quick Wash is too limited to satisfy your assay requirements, use the LHC or the keypad to define a wash protocol. All wash parameters can be defined during protocol creation, including those designed for special assays.

Quick Prime (Keypad only)

Priming removes air bubbles from the tubing, ensuring optimal performance. Fluid is dispensed to and aspirated from the priming trough. You can use Quick Prime to comply with the daily maintenance recommendations.

Select **QUICK>FULPRM** or **MANPRM** to prime the washer.

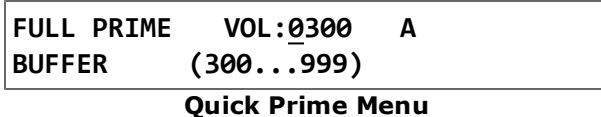

- Choose **FULPRM** to flush all the tubing, when changing fluids, for example. The valid volume range is displayed, 300 to 999 mL in the above example.
- Choose **MANPRM** prior to running a protocol to correct for evaporation, i.e. to normalize the dispense tips and remove any air from the manifold.
 - **VOL:0300 mL** shows the dispense volume per well in milliliters.



To change the dispense volume, use the arrow keys to move the cursor to the desired number position. The cursor appears to underline a number: 0010. When the correct position is selected, use the number pad to enter the desired value. Or, press Options to increment the value, Shift+Options to decrease the value.

- **Buffer** is offered on washers with Buffer Switching to select the buffer valve. The current selection is displayed in the top right corner of the LCD.



When the desired values are entered press **Start**.

See [405 Recommendations for Priming the Washer on page 39](#).

Create or Edit a Protocol (Keypad Only)

At the main menu:

1. Select **DEFINE**, and then, **CREATE** or **EDIT**.

CREATE

2. **Name** the protocol and select the **Plate Type**. Press **Enter** after making selections to proceed. **See**

EDIT

Select the protocol to edit: enter its number or use the **Options** key to scroll through the stored

**How to name a protocol
(Keypad only) on the facing
page**

- protocols to select one. Then, you can edit the name and plate type, if desired. Press **Enter** to proceed.
- Define or modify the plate type using the Previous and Next buttons to scroll through the supported Plate Types (if applicable).
 - Select **ADD** to define the first step: then, select the wash action or **SHAKE** to mix or soak the plate's contents. **EDIT** the first step or press the **Options** key to scroll to the step you want to change in a multi-step protocol.
 - Define the step's parameters. Press **Enter** to proceed.
 - Keep Added Step? | Save Step Changes?
Select **Yes** or **No** using the Soft-keys to save or discard your inputs for the current step.
- * Press **Main Menu** to end the session at any time. Then, select **RUN** and select the protocol to run it.

How to name a protocol (Keypad only)



At the **Name** screen when you are creating or editing a protocol, you can enter up to 16 alphanumeric characters to name the protocol:

- Press **Shift** + the number key for **A-H**, or scroll through the alphabet with the **Options** key for **A-Z**.
- Press **Shift +Options** to reverse direction.
- Use the arrow keys ◀ ▶ on either side of the **Options** key to move the cursor within the display.
- Press its Soft-key to add one of the four symbols (- % & _) in the display to the protocol name.
- Press **ENTER** when you are finished to store the protocol name.

■ If the name already exists, an Invalid Protocol Name message displays and you must enter a unique name.

Define the Plate Type and Plate Map (or Partial Plate)

Washing and dispensing to a part of the plate is limited by the foot print of the hardware. When washing 384-well plates, you can choose the sectors to be processed or skipped. This requires defining a “plate map.” By default, the whole plate is processed.

Quick Wash

- When defining a quick routine, select **Plate** with the Soft-key to set the plate type, and to define the plate map.

Protocols: Wash and Dispense

- When creating or editing a protocol (Define mode), set the **Plate Type** after naming the protocol. Use the **Next** or **Previous** button to scroll through the options.
- To define the plate map:
 - **Wash** step: select **OPTS** > **FORM**. First choose the processing mode **Sector** or **Plate** (described below). Then, proceed to the plate map screen.

To change the plate type:

- **DEFINE mode:** When defining a protocol, press **Next** or **Previous** to specify the plate type.



The two-line display changes to show a representation of the current plate type’s sectors in the top line, with each sector as a filled or empty square; empty sectors will not be washed. Press the **Options** button to toggle the sector to filled or empty.

Press the **Clear** button once to empty all the columns. Press it again to fill all the columns. This is useful when you want to dispense to only a couple columns.

To change the plate map (selected columns):

1. When defining a protocol, press Enter until the plate map screen is shown.
2. ◀ ▶ Use the arrow keys to move the cursor to the column/sector you want to change. The cursor underlines the currently selected column and its number is shown in the display. (In the top example, column 2 is currently selected.)

3. Press the **Options** key to toggle between filling the column or not. When the image of the column is filled it will be dispensed to. Conversely, when the column image is blank or unfilled, the column will not be dispensed to.
4. Press **Enter** to save the settings and continue.

Wash Step Format: Plate or Sector

When washing a high-density plate you can choose between two processing methods, Plate or Sector:

- **Plate format** performs each wash cycle to the entire plate before it starts the next cycle.
- **Sector format** performs the entire wash step to each sector of the plate before it moves to the next sector. A sector is defined by the manifold's footprint:
 - 96-tube manifolds process 384-well plates in 4 evenly spaced sectors (quadrants);
 - 192-tube manifolds process 384-well plates in two sectors: even and odd numbered columns.



Use sector mode when you are concerned about the fluid drying out before the procedure is completed. To learn more [See About Wash Processing Patterns on page 111](#)

How to shake the plate

These instructions are for keypad control.

The shake command is tied to the **Soak** option. These instructions apply to soaking or incubating the plate at room temperature, as well as shaking.

There are two ways to specify a shake period:

- **During a wash cycle:** To shake (and/or soak) in between every wash cycle, select **OPTS** when defining [Wash Step Parameters](#) and then select **MIDCYC**, and follow the prompts to specify parameters.
- **Shake step:** create a protocol to shake the plate, it can be a one-step, shake-only protocol, or you can **ADD** a Shake step before or after another step.

■ [See Create or Edit a Protocol \(Keypad Only\) on page 48](#)

■ Soak is not the same as "submerge" the tips. You must define a prime step or use the AutoPrime feature to soak the tips in the priming trough.

■ Soak is equivalent to incubating the plate at room temperature or delaying the protocol.

- Shaking and soaking the plate is also an option when defining a Wash step.

How to enter negative numbers (Keypad only)

Some protocol parameters, like Horizontal Dispense Position (X-axis), require inputting a negative number to improve performance.

To enter a negative value:

1. Using the number pad, start at 00 (zero) and press **Shift +Options** to display the minus sign.
2. Use the number pad to enter the desired value. The minus sign will remain, making it a negative value.

How to copy a protocol

You can save significant time creating protocols by copying a protocol that shares some of the same protocol parameters and then editing the copy to meet your needs.

LHC users: Open the protocol you want to copy and select **File>Save As**. Assign unique file and protocol names to it. Consult the Help to learn more.

Keypad users:

1. Select **DEFINE** at the main menu.
2. Select **Copy**.
3. Choose the type of protocol you want to copy.
4. Use the **Options** key or enter the protocol number to select it.
5. Enter a unique name for the new protocol you are creating.
6. Select **Yes** to copy the protocol. Then, you can edit the protocol, as needed.

How to delete a protocol

You can delete protocols to prevent other users from running them.

LHC users: use Windows Explorer or My Computer to delete the protocol file from your PC.

Keypad users:

1. Select **DEFINE** at the main menu.
2. Select **DELETE**.
3. Use the **Options** key or enter the protocol number to select it.
4. Select **Yes** to delete the protocol.

Using LHC to Control the 405™ Washer

BioTek's Liquid Handling Control (LHC) software offers another way to design protocols and control the instrument. The washer must be attached to and communicating with your personal computer (PC) for the LHC to function.

Predefined Protocols

BioTek provides predefined protocols for maintenance routines, instrument qualification, and other purposes like serial dilutions.

 Click the **Open** button and locate the **405 LS** folder to open a predefined protocol. Learn how to Customize the Predefined Protocols on page 41.

Introducing the LHC Workspace

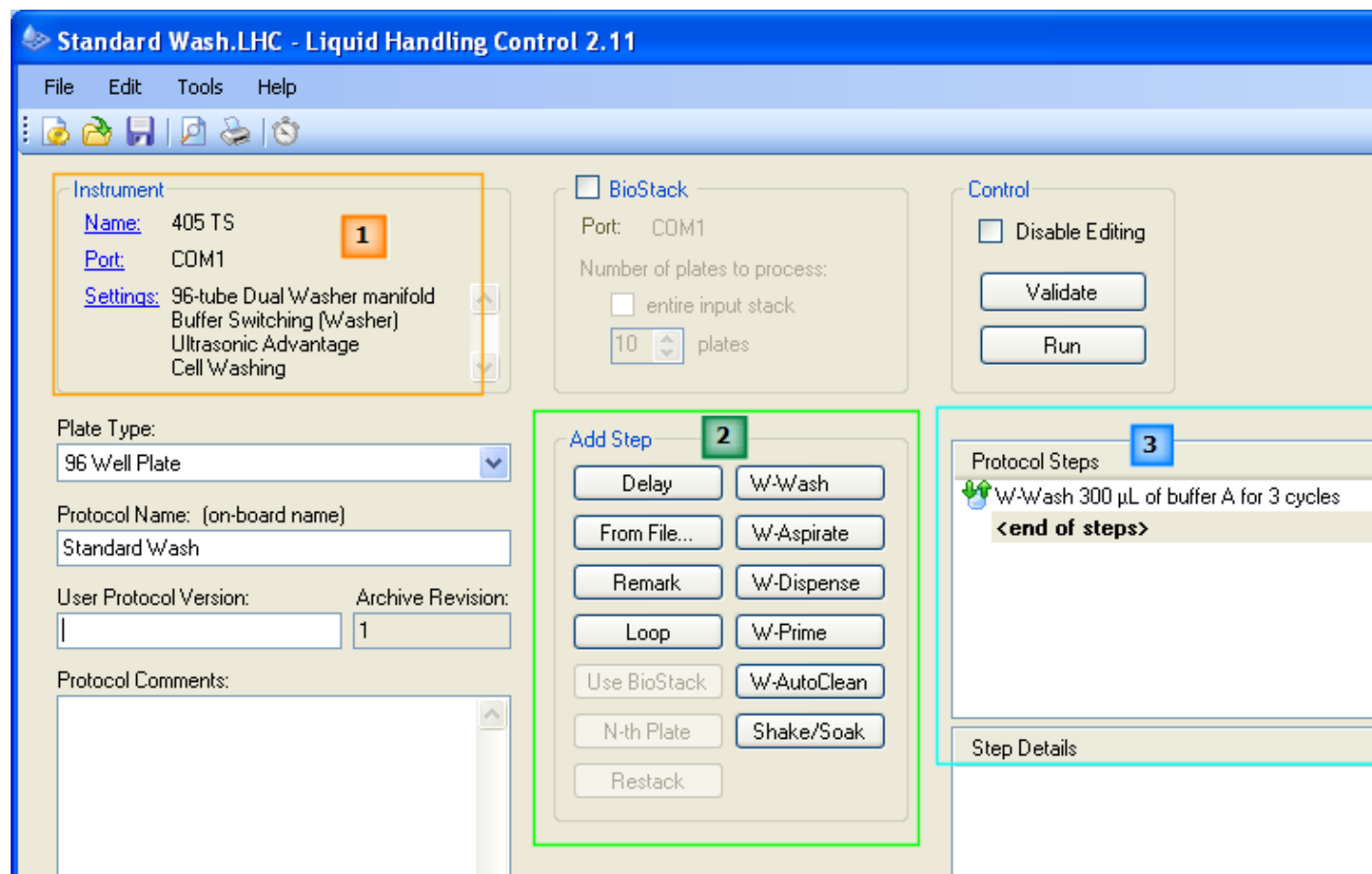

1 **Instrument Settings:** Click the **Name** link and select your instrument.

2 **405 Steps on the facing page**

3 [Define a Protocol](#): select **Help>Help Topics** to learn how.

Communications Port

Click the Port link in the main screen

The LHC needs to know the **COM Port - Communications Port: USB or Serial component on the instrument** used to connect the washer to the computer.

- Make sure the 405 LS is connected to the computer, turned on, and not busy.
- Learn more **About COM Ports** in the **LHC Installation Guide** or select **Help>Help Topics**.

Click **Test Communications** after entering the number to verify its accuracy. The LHC will display a message.

If communication is unsuccessful:

- **Check the cabling**: make sure you're using a new/undamaged BioTek-supplied cable and it is properly inserted into the instrument's USB or serial port.
- **Turn on the washer**: make sure the instrument is on and not busy processing a plate, running AutoPrime, or performing a system test, for example.
- **Retry**: contact [BioTek TAC](#) if you are still unable to establish communication between the instrument and the PC.

405 Steps

Click the action button and define the parameters to add that step to the protocol:

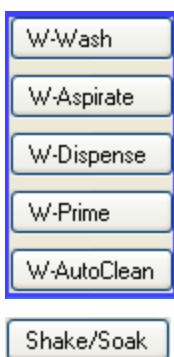

W- for steps performed by the **Washer**.

[Shake and soak](#)

Each step is executed sequentially. Specific sequences are required when using the BioStack. Any errors will be identified when you press the **Validate** button.



See [How to define a Protocol \(LHC only\)](#) on page 59

LHC Protocols

BioTek provides predefined protocols for maintenance routines, instrument verification, and general samples for common applications like serial dilutions.

Review the **Predefined Protocols on page 43**

Customize the Protocols

Typically, you must modify the predefined protocols to match your instrument configuration and to meet your assay requirements.

Instrument Settings: In addition to action steps, every protocol file contains instrument settings, including COM port, manifold type, and so on. Edit the protocol to match your instrument's COM Port and other configuration details:

- Customize the Predefined Protocols on page 41
- **Power Users:** If you create protocols for multiple instruments or for other LHC users, [read this](#) more detailed description of how the 405 LS validates a protocol to be run on a specific instrument.

■ **Recommended:** Before changing a predefined protocol, select **File>Save As** and give it a unique name. This practice preserves the custom protocol in the case of a future upgrade.

File Location

The LHC installs the protocols in the Windows Common Applications Data Folder:

- Windows® XP: C:\Documents and Settings\All Users\Application Data\
- Windows® Vista™ and Windows 7: C:\ProgramData\

The file location path continues:

[CommonAppDataFolder]**BioTek\Liquid Handling Control v.#\Protocols\405 LS**

Three folders are provided:

- **\Prime and Maintenance:** the recommended daily and periodic maintenance routines; the 405 provides distinct maintenance protocols for models with Buffer Switching (4Buffer) and those without (1Buffer);
- **\QC:** some of the quality control or performance verification procedures;
- **\Samples:** examples of common applications, including washing 96- and 384-well plates, performing serial dilutions, and a cell wash protocol.

LHC Protocols Explained

Prerequisite

This discussion about 405 LS protocols will be easier to follow if you are already familiar with the LHC. Read "Understanding the LHC" in the Help.

Protocol Files

In addition to the "Protocol Steps" (the actions you tell the 405 LS to perform to process plates), each protocol file contains "Instrument Settings."

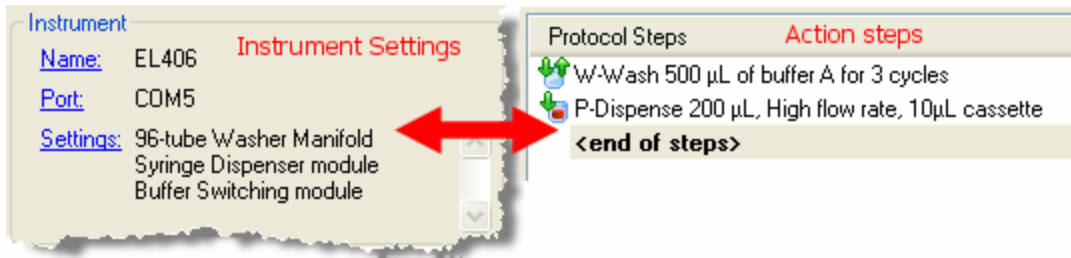

The LHC must know an instrument's settings in order to create a protocol that will run on that instrument. This virtual "Target Instrument Settings" feature lets you write protocols when the instrument is not connected to your computer.

Generally, and especially when you are managing only one instrument, the best practice is to always match the instrument settings to your instrument. (Select "Get actual settings" from the connected instrument. Unless the instrument is not connected to the computer, then, you must specify the settings.)

The "Instrument Settings" stored in the protocol file include the COM port and configuration details like the type of manifold installed and other details that are critical to controlling the instrument.

 The LHC keeps track of the last-used COM port for an instrument type. For example, when an EL406 runs a protocol, the LHC logs the COM port used and the next time an EL406 is used, the LHC applies the same COM port setting. You can disable this feature by defining your **Ports** preference: select **Tools>Preferences>Ports**.

To correct the COM port for the current protocol, click the **Port** link and use the drop-down list to select the correct value. The LHC stores the COM port value in the protocol file.

Managing Multiple Instruments

The target instrument settings feature is useful for those managing multiple instruments. In addition to the flexibility of being able to create protocols for non-connected instruments, you can create and save an instrument settings file for each of your liquid handlers, another time saver.

Protocols are considered valid when an instrument can successfully perform the protocol. The LHC will run a protocol even when the instrument settings do not match the physical configuration of the instrument. For example, a protocol with instrument settings that include Buffer Switching can be run by an instrument without Buffer Switching when none of the steps actually call for different buffer valves, i.e. all steps use the same buffer.

Validate versus Run



Validate checks the action steps against the protocol's Target Instrument Settings.

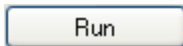

Run talks to the instrument to check the action steps against the instrument's onboard settings.

Validate will catch errors when the Instrument Settings have been changed after the protocol steps have been defined and there is a mismatch. **Run** performs a similar validation before executing the protocol. Errors are not reported unless the steps cannot be performed.

Target Instrument Settings

- For LHC users only.

Click the **Settings** link in the main workspace

Actual Instrument or Simulated Instrument? That is the question for the Target Instrument Settings dialog.

When the 405 LS is:

- connected to the computer: it is best to "Get (the) **actual settings**" from it;
- not connected to the computer: you must define the settings.

One vs. Multiple Instruments

- If you are running only one instrument, always "Get the actual settings" to identify the exact configuration of your 405 LS to ensure it can successfully perform the wash protocols.
- If you are managing multiple BioTek instruments (or one instrument with multiple configurations): you can create and save a "settings file" for each instrument to help create protocols for that instrument when you are not connected to it. See below.

The "instrument settings" tell the LHC what the instrument can do, e.g. fill a 384-well plate or not. It is impossible to create a protocol without this information. [Read](#)

this to understand the correlation between the Target Instrument Settings and the protocol.

Get settings from:

- **Instrument:** BioTek configures and tests the 405 LS at the factory before shipping it. If you have not changed the instrument's onboard settings, you can safely click the [Get actual settings now](#) link to upload the correct settings from the instrument.
- **Settings file:** If you have previously saved the instrument's settings to a file (using the [Save](#) link), click this link to import them.
- **This screen:** manually define the instrument's settings and click **OK**. This option does not affect the instrument's onboard configuration settings. It lets you define protocols for an instrument with the specified components.

Configured with:

Select the appropriate devices to identify your instrument's components:

- **Washer Manifold:**

96-tube Single	96-well plates only
96-tube Double	96-well and 384-well plates
192-tube	384-well plates only

- **Buffer Switching:** when this external valve module is installed for automatically switching wash buffers/reagents for either the washer or Syringe dispenser.
- **Vacuum Filtration:** when the instrument is equipped with the special carrier for washing filter-bottom microplates.
- **Ultrasonic Advantage:** when the instrument is equipped with the stainless steel reservoir and ultrasonic cleaning capability.

Save Settings File

If you have multiple instruments or use one instrument in multiple configurations, you can create unique settings files for each configuration and save time when defining protocols for that configuration.

Click the [Save](#) link and use Windows' file-saving dialog to create a .SET file based on the currently-selected parameters. Then use the [Get "settings from a previously saved"](#) link to load the parameters.

How to define a Protocol (LHC only)

- For keypad instructions: Create or Edit a Protocol on page 48

In short:

- Select the [Plate Type](#) and assign a unique Protocol Name Limit the name to 16 alpha-numeric characters if you want to run the instrument using the keypad only, i.e. disconnected from the computer..
- Click a button in the [Add Step](#) area.
- Define the parameters for the step in the dialog that opens.
- Continue adding steps, if desired.
- Save the file and/or click **Run** to execute the protocol.



Double-click a step in the protocol to open it for editing.

- Highlight a step and press **Delete** to remove it.
- Click and drag a step to change its sequence order.

How to shake the plate

Shake/Soak

Add a **Shake/Soak** step to the protocol to shake the plate.

1. In the [Protocol Steps](#) box, highlight the step you want the shake to follow, and click the **Shake/Soak** button.
2. Define an adequate duration and intensity to sufficiently mix the fluids in the plate.

Leave the [Soak](#) option disabled when you only want to mix the plate contents, i.e. perform a stand-alone shake step. Alternatively, enable the option and set a duration to delay the process to allow the fluids to interact.

- Soak is not the same as "submerge" the tips. You must define a prime step or use the AutoPrime feature to soak the tips in the priming trough.

- Soak is equivalent to incubating the plate at room temperature or delaying the protocol.

- Shaking and soaking the plate is also an option when defining a Wash step.

How to use the Adjust Utility- LHC

This page describes how to use the LHC to run the Adjust Utility. [See Run the Adjust Utility \(Using the Keypad\) on page 109.](#)

- Learn about the [Adjust Utility.](#)

- Keep in mind the [positional limits](#) of the devices during operation.

1. Put a plate on the carrier.
2. Select **Tools>Instrument Utilities>General Settings** and click **Adjust Utility** under **Instrument Functions**.
3. Choose the **Selected Device** and the starting position to **Measure offset** from using the drop-down lists.

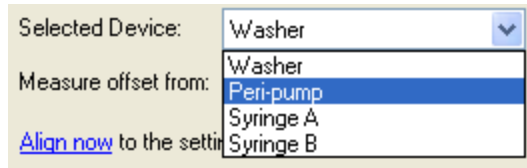

4. Set the **Plate Type**.
5. Click the **Align now** link.

The utility positions the plate according to your selections. Take a close look at the current position of the selected device above the wells to determine the required adjustments.

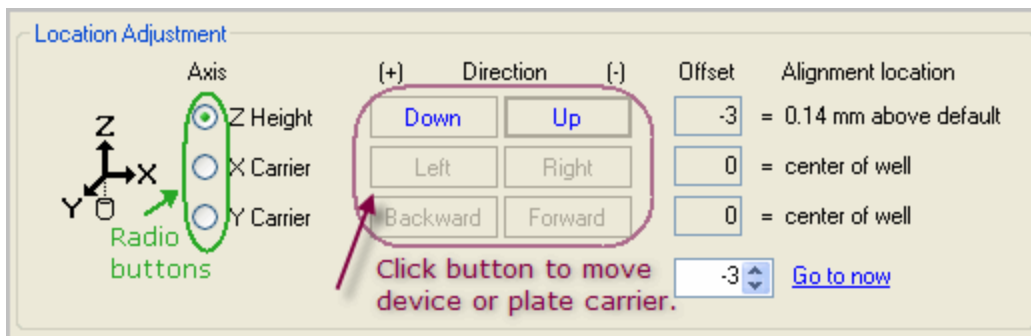

6. Use the radio buttons to select the **Axis** you want to adjust.
7. Use the **Direction** buttons to move one step at a time. Press the companion button to reverse direction.

To move multiple steps at a time, use the numeric field next to the **Go to now** link. Enter a positive or negative number of steps to move the device or plate carrier and click the link.

The **Offset** is shown in number-of-steps and mm.

8. Repeat the process for each axis, as necessary, starting at step 6.
9. Jot down the **Offset** values so you can enter them when defining the protocol step.
10. Click **Home All components** to end the session.

Upload-Download Protocols (LHC Only)

The LHC lets you transfer protocols from your computer to your instrument and back again.

Limitation: Protocols must contain only instrument-supported action steps to qualify for download. That is, the protocol cannot contain any of the LHC provided steps like Delay and Loop (buttons in the left column of the [Add Step](#) box in the main view). And, a [Protocol Name](#) is required.

- The instrument's main menu must be displayed for the LHC to communicate with it.

1. Select **Tools>Transfer Protocols**.
2. Make sure the desired protocols are displayed: check the [Protocol Folder](#) path for [This computer](#). Refresh the list of protocols onboard the [Instrument](#) by clicking the [Settings](#) link.
3. Highlight one or more protocols in a display box. (Hold the Ctrl or Shift key to simultaneously select multiple files.)
4. Optionally, at the top left corner of the screen, choose to [Disable Editing](#) of transferred protocols to lock the protocols from editing or deleting when they are onboard the instrument.
5. Click the applicable **Upload** or **Download** button.

The LHC will confirm the transfer or prompt you for more information. When the transfer is complete, you can manipulate the files as you normally would in their new location.

Wash Step Parameters Table

See [Plate Types Table](#) on page 111 for default Z-axis values or dispense heights.

Minimally, a wash step includes an aspirate step followed by a dispense step. Select and define each option to customize the parameters for your assay.

Keypad name	Option	Description/Values range	Default values
CYCLES	Number of wash cycles:	Each wash cycle first aspirates and then dispenses fluid to and from the plate.	3
ASPIR	Aspirate	Vacuum Filtration: Select standard aspiration (Top) or Vac for filtration.	

Keypad name	Option	Description/Values range	Default values
	Filtration Time:	When applicable, specify duration of vacuum filtration in seconds. 5-999	30
	Travel Rate:	The rate at which the washer manifold travels down into the wells. The selection range is 1 to 5 for non-cell-based assays, from slowest to fastest. With these rates, the tubes slow their descent as they approach the defined aspirate height (Z Position) to aid complete evacuation of the well.	3
		For delicate, cell-based assays, the range is 1CW (cell wash) to 4CW and 6CW. These rates minimize turbulence in the wells. The tubes descend at a constant rate to the specified height. Rate 6CW creates the least disturbance and performs fastest.	
	Delay:	Amount of time the tubes stay at the aspirate height before lifting out of the wells. Define a delay between 0 - 5000 ms. Increasing the delay may improve evacuation of the wells.	0
	Positioning:	X- and Y- horizontal axes, Z- height (vertical) axis can be adjusted to improve performance. Default Z-axis for 384-well plates is 22 steps, 2 for 384-well PCR plates.	Z = 29 for 96-well plates; X & Y = 0
	Secondary aspirate:	Also called Crosswise Aspiration. First the wells are aspirated using the position defined above. The aspirate tubes rise and then descend to the secondary position to aspirate again.	No
DISP	Dispense		
	Flow Rate: 96-tube & 192-tube manifolds	The rate at which the fluid is dispensed from the tubes. For cell-based assays, use rate 1 or 2 for gentle washing with the 96-tube manifold only. For normal dispensing, the range is 3-11, 3 is slowest and 11 is fastest.	7

Keypad name	Option	Description/Values range	Default values
	Volume:	μ L/well dispensed range: 96-tube manifold: 50-3000 192-tube manifold: 25-3000	μ L/well: 96= 300 384= 100
	Buffer:	Buffer bottle selection. A-D	A
	Positioning:	X- and Y- horizontal axes, Z- height (vertical) axis can be adjusted to improve performance. Default Z-axis for 384-well plates is 120 steps; 83 for 384-well PCR plates.	Z = 121 for 96-well plate
	Vacuum Delay	Suspends the vacuum pump until a certain volume is dispensed. This feature is critical to cell wash operations. It delays normal aspiration until the specified volume has been dispensed to the wells. The range is 10 to 350 μ L/well.	10
OPTS	Options		
	PRE	Pre-wash options: Pre-dispense, Bottom wash (if applicable)	
	MIDCYC	Mid-cycle options: Shake, Soak, Pre-dispense between cycles,	
	POST	Post-wash option: Final Aspirate	
	FORM	Format for washing 384-well plates: Plate or Sector	
PRE	Pre-wash	Actions performed before the wash cycles begin	
	Pre-dispense	Quick, small prime to condition the tips before dispensing.	No
	Flow Rate:	96-tube & 192-tube manifolds: The range is 3-11, 3 is slowest and 11 is fastest.	9
	Volume:	μ L/tube dispensed range: 96-tube manifold: 50-3000 192-tube manifold: 25-3000	μ L/tube: 96 = 50 192 = 25
	Bottom wash	Bottom washing adds an initial wash cycle to the specified number of cycles. Fluid is	No

Keypad name	Option	Description/Values range	Default values								
		simultaneously dispensed and aspirated to create cleaning turbulence (at the specified height). The manifold descends to aspirate again and ends with a final dispense to fill the wells.									
	Rate:	Valid range is 3-11. The cell wash rates, 1 CW and 2 CW, which use low-flow tubing, are available but not recommended. Cell wash options are designed for gentle washing, while bottom wash is designed for vigorous washing.									
	Wash Volume:	25-3000 μ L/well dispense	250								
	Positioning:	X- and Y- horizontal axes, Z- height (vertical) axis can be adjusted. Repositioning the tubes to harder-to-reach areas of the wells may the improve results.									
MIDCYC	Between cycles										
	Shake	To mix the contents of the plate.	No								
	Duration	From one second to one hour.	5 sec.								
	Intensity	<table border="1"> <thead> <tr> <th>Intensity</th> <th>Hertz</th> </tr> </thead> <tbody> <tr> <td>Slow</td> <td>7</td> </tr> <tr> <td>Medium</td> <td>13</td> </tr> <tr> <td>Fast</td> <td>19</td> </tr> </tbody> </table>	Intensity	Hertz	Slow	7	Medium	13	Fast	19	Medium
Intensity	Hertz										
Slow	7										
Medium	13										
Fast	19										
	Soak	Delays wash for the duration to allow fluids in the plate to steep or incubate.	No								
	Duration	From one second to one hour.	30								
	Home carrier	To perform the shake or soak in the home position or not. But, the plate carrier is moved home when the total duration of the shake and/or soak exceeds 1 minute. The vacuum pump is turned off in this scenario. Moving the plate home prevents contaminating it with drops from the manifold.	No								

Keypad name	Option	Description/Values range	Default values
	Pre-dispense between cycles	To wet or condition the manifold tubes between cycles, which is only needed after a long soak. Same parameters as regular pre-dispense.	No
POST	Post wash	When all cycles are completed.	
	Final Aspirate	A final aspiration is performed to completely evacuate the wells. Same parameters as regular aspirate step.	Yes
FORM	Wash format	Manner of processing large-format plates	Plate
	Sector	Performs the entire wash step on one sector of the plate before it moves to the next sector.	
	Plate	Performs each cycle to the entire plate before it starts the next cycle.	

Shake/Soak Step Parameters

Shake/Soak

Select the action to perform:

- **Move** carrier to home position first.
Regardless of selection, the plate carrier is moved home when the total time of the shake and soak durations exceeds 1 minute. The vacuum pump is turned off in this scenario. Moving the plate home prevents drops from contaminating the plate.

■ Note: The Shake/Soak step is performed wherever the carrier is positioned. In a multi-step protocol it is likely the step previous to a shake/soak will leave the plate carrier in its home position. In this case and when it is the first step in a protocol, the step will be performed at home.

- **Shake** settings:
 - **Duration:** enter numeric values to shake the plate for up to 1 hour.
 - **Intensity:** use the drop-down list to select a shake intensity. "Variable" cycles through the other levels of intensity.

Intensity	Hertz
Slow	7
Medium	13
Fast	19

Choose the intensity that most closely matches your assay kit instructions.

- **Soak:** allows buffer/dispense fluid to remain in wells for the specified duration, i.e. processing is delayed:

- **Duration:** enter values to stop processing the plate for up to 1 hour (59 minutes, 59 seconds).

■ Soak is not the same as "submerge" the tips. You must define a prime step or use the AutoPrime feature to soak the tips in the priming trough.

■ Soak is equivalent to incubating the plate at room temperature or delaying the protocol.

■ Shaking and soaking the plate is also an option when defining a Wash step.

Pre-Dispense

Wash and Dispense Step option

Also called **Tip Priming**.

Valid volume ranges:

Manifold	µL/tube	Default value
96-tube	50-3000	50
192-tube	25-3000	25

About the Pre-Dispense Options

Enable the Pre-dispense options to condition or normalize the dispense tubes before dispensing fluid. This is recommended for precise dispensing to mitigate evaporation or any potential fluid imbalance at the ends of the tubes.

The pre-dispense options are not intended to fully prime the tubing, for example, when changing fluids. Be sure to fully **Prime** the device to remove all air from the tubing before commencing a dispense step. Use the Pre-dispense feature to quickly prime the tubes or tips between runs.

When a Pre-dispense is enabled, the 405 LS moves the plate to the home position to allow the manifold to dispense into the priming trough.

How to condition the tips before dispensing

- W-Dispense In a stand-alone **Dispense** step: select the [Advanced Options](#) link and fill the Pre-dispense checkbox;

- Wash In a Wash step, select the [Show Wash Options](#) link and fill the Pre-dispense checkbox.

Washer Flow Rates

The default setting for flow rates is 7, in the middle of the range for standard tubing rates 3-11, 3 is the slowest, 11 is the fastest. Slower rates are recommended for viscous fluids.

Dual 96-Tube Manifold: When this manifold is installed, you can select rate 1 or 2 to use the low-flow tubing to dispense fluid slowly and gently to avoid damaging well contents.

	Rate	µL/tube/second	
		96 tube	192 tube
Cell Wash	1	116*	NA*
Cell Wash	2	134*	NA*
	3	204	102
	4	244	122
	5	273	136.5
	6	306	153
Default	7	325	162.5
	8	352	176
	9	375	187.5
	10	391	195.5
	11	418	209

*Cell Wash flow rates direct fluid through special low-flow tubing, which is not compatible with the single 96-tube and 192-tube wash manifolds.

Aspirate Travel Rates

Rate	mm/sec	
1	4.1 +1	Slowest
1 CW	4.1	
2	5.0 +1	
2 CW	5.0	
3	7.3 +1	Default rate
3 CW	7.3	

Rate	mm/sec	
4	9.4 +1	
4 CW	9.4	
5	9.4 +2	Fastest
6 CW	14.7	Recommended rate for Cell Wash protocols

CW rates are specially designed travel rates that minimize turbulence in the wells for [Cell Wash protocols](#).

Standard rates (1-5) show two speeds as they approach the well because they slow down to 1 or 2 mm/sec before reaching the aspirate height to provide more time to aspirate the fluid, improving evacuation. Conversely, the CW rates do not change speeds, they move into and out of the well as quickly as possible to limit turbulence.

How to define a Final Aspiration step

By default, wash steps include a final aspiration step because a common objective is minimizing the residual left in the wells during a wash cycle. You can enable, disable, or modify the parameters of the final aspiration step.

- Important info for **Vacuum Filtration** Assays: Be sure to reset or disable the Final Aspiration step to match your assay requirements.

Edit the Wash step to modify the Final Aspiration:

LHC Users:	Keypad Users:
<ol style="list-style-type: none"> 1. Double click the step in the protocol to open it for editing. 2. Fill the checkbox to enable Final Aspirate and click the Definition link to define the parameters to suit your assay. 	<ol style="list-style-type: none"> 1. Edit the Wash step or stand-alone Aspirate step: Define>Edit>select protocol, and if necessary press Options to scroll to the desired step. 2. Select OPTS>POST and select Yes, or modify the Final Aspirate step by pressing Enter. 3. Define or modify the parameters to suit your assay.

Add a secondary aspiration to a wash cycle

When too much residual is left in the wells during a wash cycle, you can add a secondary aspiration to reduce it. Secondary aspiration can be performed immediately after each aspiration in a wash cycle and/or after the final aspiration step.

- Secondary aspiration is also called Crosswise aspiration because it is typically performed in a different location within the well. Reposition the tubes by defining different X-, Y-, and/or Z-axis positions when enabling the secondary aspiration for the most effective evacuation of the wells.

Edit the Wash step or stand-alone Aspirate step to add a secondary aspiration:

LHC	Keypad
<ol style="list-style-type: none"> 1. Double click the step in the protocol to open it for editing. 2. Click Advanced Options (for Aspirate) and enable Perform Secondary Aspirate. 3. Apply a second aspiration to the Final Aspirate, also, for best evacuation results. 4. Optionally, adjust the position of the manifold as it addresses the wells. 	<ol style="list-style-type: none"> 1. Edit the Wash step or stand-alone Aspirate step: Define>Edit>select protocol, and if necessary press Options to scroll to the desired step. 2. Select ASPIR and press Enter until Secondary Aspirate is offered. And/or select OPTS>POST to add a second aspiration to the Final Aspirate. 3. Select YES to perform a second or crosswise aspiration. 4. Specify a crosswise position for the manifold as it addresses the wells.

For example, you may want to adjust the X- or Y- axes to get to hard-to-reach areas of certain types of wells. Or, you may want to lower the height (reduce the Z-axis), to better evacuate fluid.

Run the Adjust Utility: To determine the precise positioning of the dispense and aspirate tubes.

Bottom Wash

Bottom washing adds an initial dispense/aspirate sequence, another wash cycle, to the specified number of cycles. Fluid is simultaneously dispensed and aspirated to

create cleaning turbulence (at the specified height). The manifold descends to aspirate again and ends with a final dispense to fill the wells.

Buffer: Select the buffer to use, if applicable.

Bottom Wash Volume: Enter the volume of wash solution to dispense per well during the bottom wash.

Flow Rate: Set the rate. Valid range is 3-11. The cell wash rates, 1 CW and 2 CW, which use low-flow tubing, when available, are not recommended. Cell wash options are designed for gentle washing, while bottom wash is designed for vigorous washing.

Advanced Options

Parameters	Description
Bottom Wash Height: Z-axis Position	The distance between the bottom of the aspirate tubes and the carrier surface. The valid range is 12 to 175. The value in mm is displayed on screen.
Horizontal X-axis Position	The left and right position of the dispense tubes when the carrier is beneath the manifold.
Horizontal Y-axis Position	The front-to-back carrier position (or Y axis) to align the microplate with the manifold tubes during a dispense. The range depends on the model.
Delay start of Vacuum	until dispensing this volume. 3000 μ L max

Verify Performance

- **LHC Required for "Q" models:** you must use BioTek's Liquid Handling Control (LHC) software to run the Verify™ Technology clog detection feature.

Tools>Instrument Utilities>Verify Manifold>Run a New Test

BioTek's Verify™ Technology quickly detects clogged aspirate or dispense tubes.

Important! Before running the test:

Make sure the 405 LS is primed and ready to run:

- Fully prime the tubing/system, e.g. run **Day Rinse**.
- If necessary, empty waste vessel and tighten waste bottle cap.

Prepare to run the Verify test:

- Fill the supply vessel with at least **100 mL** dH₂O or DI water or buffer solution¹.
- Put the Verify Test Plate on the standard-mag bead plate carrier (without a magnet)² in the proper orientation: "**Front**" label is readable (well A1 in the back, left of the carrier). See also: Handling the Verify Test Plate on the facing page.

Run the Verify test:

LHC

1. Select **Tools>Instrument Utilities>Verify Manifold** and click **Run** a new Test.
 - **Buffer:** Select the bottle to use, if applicable.
 - **Prime:** optionally, prime the manifold tubes to correct for evaporation loss. 40 mL of fluid is dispensed.
 - **%CV Threshold:** optionally, change the %CV to match your lab's standard for QC tests: 5-15%. The default value of 5% is recommended.
2. Press **Start** to run the test.
3. Assess the results: Verify Results.

 Do not discard the **Verify Test Plate**. Reuse it for as long as possible. See **Replacement Procedure for Verify Test Plate on page 134** if it is damaged.

¹Do not use highly viscous fluids or wash buffers that are prone to leave significant residue on the plate.

²Vacuum filtration assays: You must uninstall the vacuum filtration plate carrier and install the standard-mag bead plate carrier to run the test. For this temporary purpose, you do not need to change the instrument's plate carrier setting to run the Verify test.

Frequency:

 **5 Minutes:** Gain complete confidence that your plates will be processed correctly by spending five minutes to run the Verify test before running your assay!

Develop a schedule for running the Verify routine based on the type of wash buffer you are using, how frequently you use the washer, and your maintenance habits:

- **Daily:** When using PBS, protein, and other fluids that easily crystallize and harden, potentially clogging the tubes, run the Verify routine every day and/or after prolonged downtimes to ensure the tubes are not clogged.
- **Weekly:** When using TRIS and other low-salt buffers and when adhering to the recommended maintenance schedule, you can confidently run the Verify routine less frequently, e.g. before new assay runs.

 Replace the **Verify Test Plate** (according to the prescribed [procedure](#)) if it is damaged, scratched, warped, etc.

For more details: [See About Verify™ Technology on page 76.](#)

Manage Test Results



Immediately after a test is run, its results are displayed. The test data file is named with the date and time. You can view previous results using the drop-down list of tests. The most recent test results are at the top of the list.

View Report file: to open a text file of the current test results. Report file names are appended with Passed/Failed results.

Configure settings: to specify a text file folder. [See Configure Verify™ Technology Utilities on page 79](#) for other useful info.

Handling the Verify Test Plate

The Verify Test Plate ships in its own special box. The plate is labeled with the serial number of the 405 LS that has been calibrated for its use.

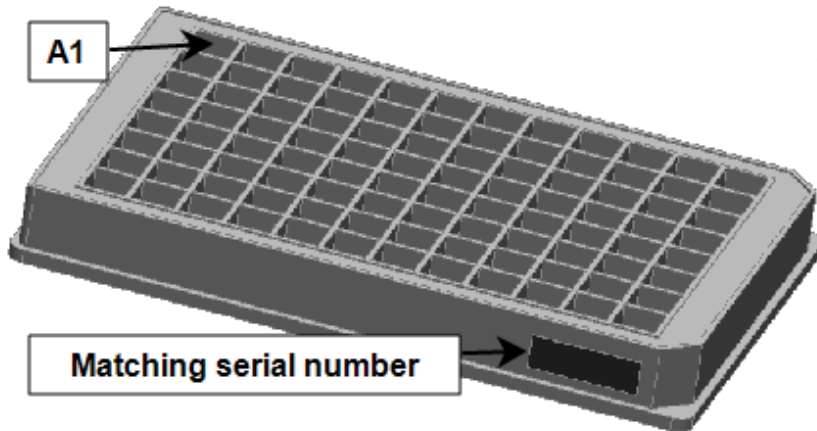

- Well A1 is opposite the chamfered or beveled edges.
- The plate is labeled with the washer's serial number.
- When the plate is on the carrier in the proper orientation, the "Front" label is visible.

Verify Test Plate

Important guidelines:

- Always put the plate on the carrier with well A1 in the back, left corner of the carrier.
- Clean the plate after each use if you are using wash buffer to run the test.
- Fully dry the plate after each use and before putting it back in its foam-lined box.
- Inspect the plate regularly for damage, e.g. scratches, chips, warping.
- Replace the plate when it is damaged. [See Replacement Procedure for Verify Test Plate on page 134](#) in the operator's manual.

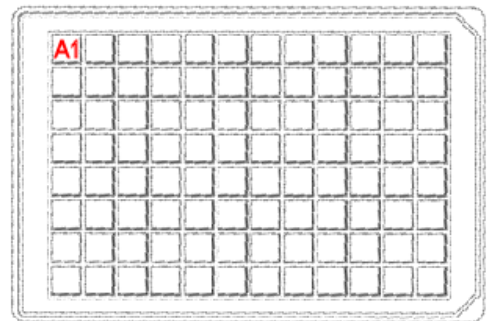

Verify™ Technology Flowchart Diagram

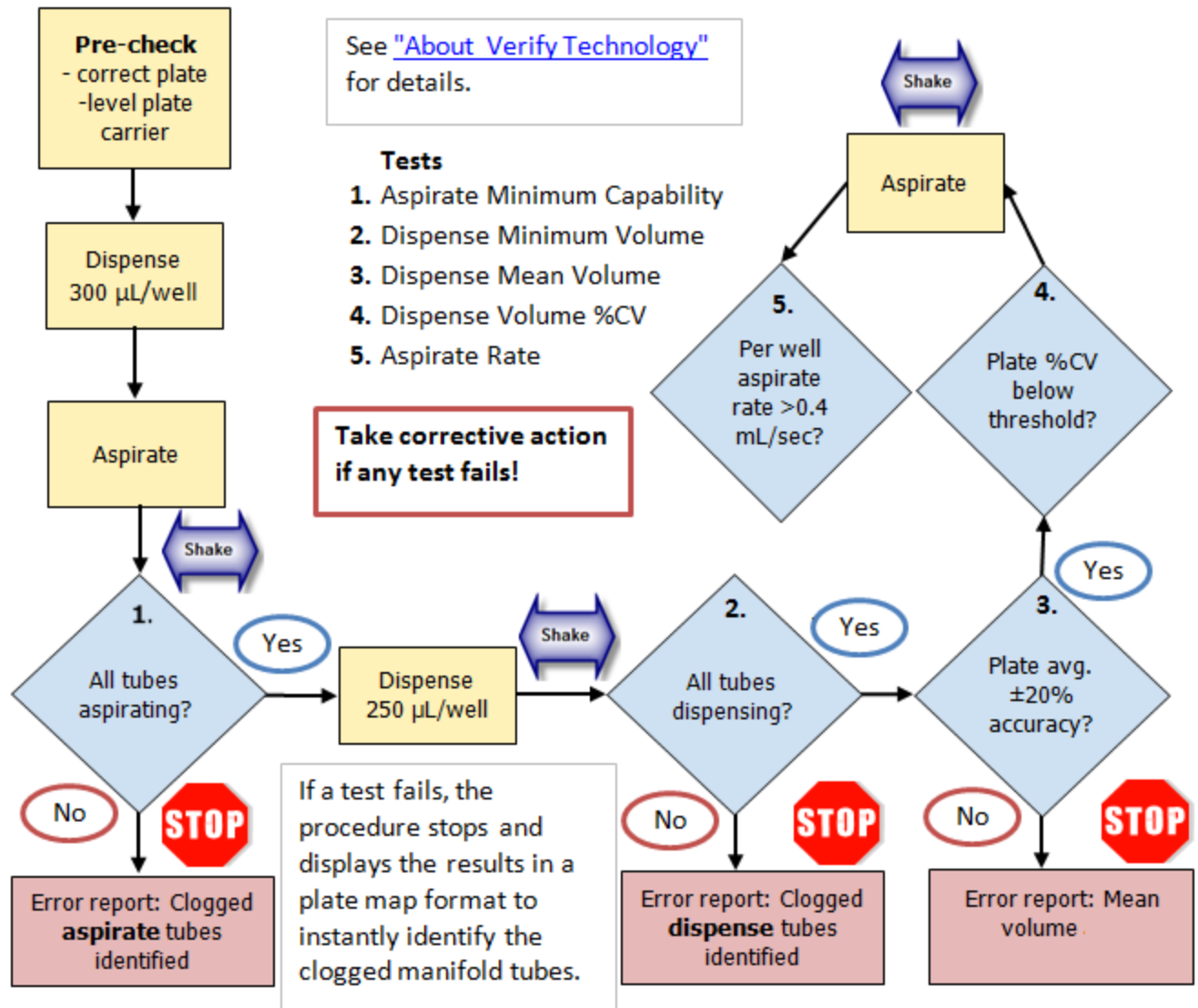

Verify Test Corrective Action

Corrective Action		
1	Clean the Manifold: begin with AutoClean/Quick Clean and rerun. If test fails again, remove the manifold to clean it more thoroughly.	See AutoClean the Washer on page 125
2	If the test fails after the manifold has been cleaned,	

Corrective Action		
	recheck the instrument setup:	
	<ul style="list-style-type: none"> • System fully primed; • Sufficient/correct fluid supply; • Vacuum pump working; • Washer on a level surface; • Supply vessels on same or higher elevation than washer; • Supply vessel filter (in bottle) unclogged; • Waste bottle cap tightened; • Inline vacuum filter unclogged. 	See Remove and clean the washer manifold on page 131
Note	<p>All or many tubes: if the plate map shows:</p> <ul style="list-style-type: none"> • all the aspirate tubes as clogged: check for a vacuum leak • clusters of dispense tubes as clogged: check fluid supply/fully primed system 	

About Verify™ Technology

BioTek's Verify™ Technology uses an ultrasonic liquid-level sensor to quickly test aspirate and dispense performance. In less than 5 minutes, the Verify routine will give you supreme confidence that assay plates will be washed according to your specifications or it will identify any clogged manifold tubes that need cleaning.

Our Verify Technology can significantly decrease the need for routine instrument quality control using fluorescence- or absorbance-based dyes and a microplate reader, as the test can be performed with dH₂O/DI water and most wash buffers by the washer itself. You can run the Verify test prior to each assay, at the beginning or end of every day, or at the frequency that best fits your lab's current practices. However, use of the Verify Technology does not alter the recommended instrument qualification schedule, i.e. dispense precision and evacuation efficiency testing should be performed monthly to confirm the washer is performing to specifications. [See **Sensitivity: Verify Sensor vs. Absorbance Reader** on page 78.](#)

See Verify™ Technology Flowchart Diagram on previous page for a graphical depiction of the process.

The Verify routine runs a pre-check and five tests:

- **Pre-check:** the sensor verifies the standard plate carrier is present and level, and the Verify Test Plate is on the carrier. All wells are aspirated to make sure they are dry.

Tests conducted by the Verify level sensor:

1. **Aspirate Minimum Capability:** Post-aspirate, this test verifies the residual volume is less than 250 μL /well.
2. **Dispense Minimum Volume:** Post-dispense, this test verifies that every well has at least 125 μL /well.
3. **Dispense Mean Volume:** Calculates the mean dispense volume: dispense accuracy of $\pm 20\%$ is expected.
4. **Dispense Volume %CV:** Calculates the dispense %CV and per-well deviation from mean.
5. **Aspirate Rate:** Calculates the aspirate rate per well in mL/seconds.

When the manifold tubes are clog-free, it is expected that all five tests pass and normal operation can be resumed. If any of the tests fail, the procedure stops and displays the results in a plate map format to instantly identify the clogged manifold tubes.

The Verify Process Flow

The Verify Test proceeds this way when not interrupted by a failed test:

1. **Pre-check:** The process begins with the pre-check described above.
2. **Dispense:** 300 μL /well dispensed to each well in the test plate.
3. **Aspirate:** All wells are evacuated.
4. Shake plate to better distribute remaining fluid in the plate and improve the meniscus.
5. **Scan:** Level sensor scans plate to measure fluid: $< 250 \mu\text{L}/\text{well}$ is expected. Generate Test 1 results.
6. **Dispense:** 250 μL /well dispensed to each well in the test plate.
7. Shake plate to distribute fluid in the plate and improve the meniscus.
8. **Scan:** Level sensor scans plate to measure fluid: $\geq 125 \mu\text{L}/\text{well}$ plus residual from aspirate step is expected. Generate Test 2 results.
9. Evaluate data and generate Test 3 and Test 4 results.
10. **Aspirate:** All wells are evacuated at the fastest travel rate (6CW).
11. Shake plate to distribute fluid in the plate and improve the meniscus.
12. **Scan:** Level sensor scans plate to measure aspirate rate: $\geq 0.4 \text{ mL}/\text{sec}$ is expected. Generate Test 5 results.

Sensitivity: Verify Sensor vs. Absorbance Reader

While the 405 LS's Verify™ ultrasonic level sensor is a reliable tool for quickly determining the current state of the wash manifold, it has greater measurement variability than a typical absorbance reader.

The Verify sensor is an excellent maintenance tool, but BioTek recommends using the more precise measurements obtained with a microplate reader for qualifying the 405 LS's performance on a monthly basis. Additionally, BioTek recommends performing an annual qualification of the Verify sensor itself, to ensure it is meeting its performance specifications. Qualify the Verify™ Technology Sensor on page 167.

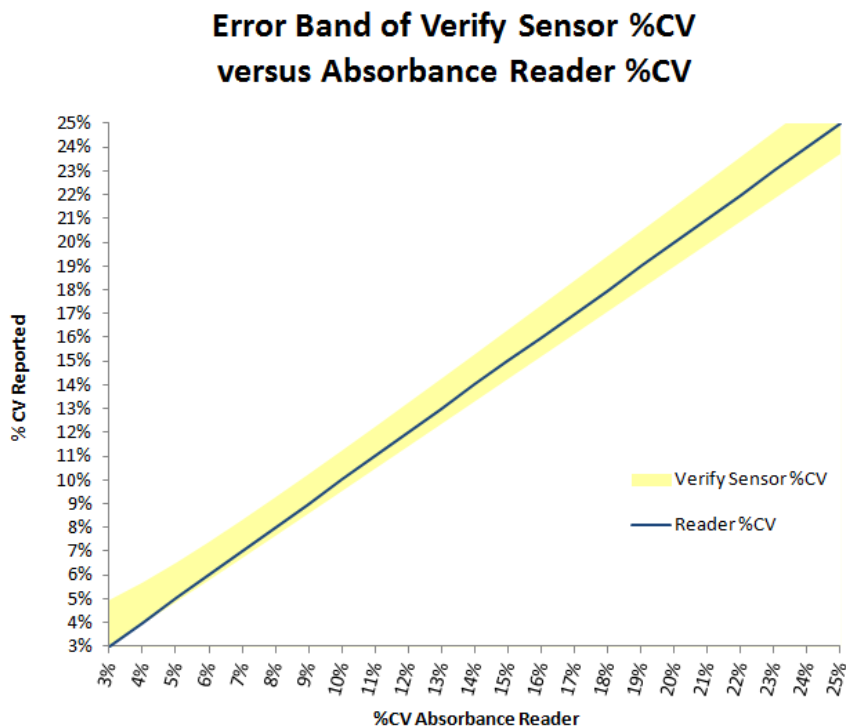

The Verify measurement variability is determined this way:

$$\% CV_{Verify} = \frac{\sigma}{V}$$

Verify %CV accuracy is determined from the sigma measurement error and mean volume measurement error. The sensor's performance specification is $\sigma_{\text{measurement}} < 9 \mu\text{L}$, (also typically $\sigma_{\text{measurement}} > 3 \mu\text{L}$). Typical volume error is +/- 14 μL .

%CV reported by the level sensor is highest when $\sigma_{\text{measurement}}$ is high and mean volume measurement error is low, and vice versa.¹

¹The error contribution of sigma measurement is found by summing the actual well volume variance and the measurement variance: $\sigma = \sqrt{\sigma^2_{\text{actual}} + \sigma^2_{\text{measurement error}}}$.

For example, if the actual sigma is 7.5, and mean volume is 250, then actual CV = $7.5/250 = 3\%$.

$$\text{And: } \% CV_{\text{Verify}} = \frac{\sqrt{7.5^2 + 3^2}}{250 + 14} \text{ to } \frac{\sqrt{7.5^2 + 9^2}}{250 - 14} = 3\% \text{ to } 5\%$$

Configure Verify™ Technology Utilities

Tools>Instrument Utilities> Verify Manifold>Configure Utilities link

- **Raw Data folder:** This field shows the path and folder that LHC creates on your PC and uses to store the test data. Every test creates an .xml data file that displays the test results in the LHC. Regularly archiving these "Raw Data" files will ensure optimal viewing performance.
- **Reports folder:** This customizable field shows where the text (.txt) files of the test results are stored. To change the folder, click the link to browse to a desired location or edit the path shown in the field.

Managing Test Results



- **Improve online viewing of test results:** If test results do not appear instantly after a test, there may be too many raw data files in the [Raw Data folder](#). Archive the data files, i.e. save the files in a different folder to restore normal performance.
- **Archive files:** Develop a schedule that compliments your current QC/QA practices to regularly archive Verify test raw data files. Use Windows Explorer to move data files (.xml) and report files (.txt) to archive folders.

Test Plate Alignment

Procedure for calibrating the level sensor to work with a replacement test plate. Depending on frequency of use, the Verify Test Plate will occasionally need to be replaced due to wear or damage. When you receive a replacement plate from BioTek, perform this procedure to update the washer's calibration data to match the new plate. [See Replacement Procedure for Verify Test Plate on page 134.](#)

Sensor Calibration

This procedure serves two purposes:

- Testing/determining the Slope and Offset volume coefficients for a specific Verify Test Plate, i.e. a step in the procedure to replace a test plate.
- Qualify the Verify™ Technology Sensor on page 167 to ensure it is performing to specification.

Advanced Settings

Do not change the slope or offset values unless specifically instructed to do so by BioTek.

Note: Instructions in the [Replacement Procedure for the Verify Test Plate](#) may recommend changing these values.

Operating with the BioStack

If you purchased BioTek's BioStack Microplate Stacker to operate with the 405 LS, here is some important information about running it:

LHC Control:

- LHC users: connect both the BioStack and the 405 LS to the computer and control them with the LHC.
- Design protocols that integrate BioStack controls with 405 LS steps. LHC protocols must contain a BioStack loop.
- In the LHC, select **Help>Tutorials**, click **Sections** in the toolbar for a drop-down menu, select **Controlling the Bio-Stack with LHC**. It only takes a couple minutes to complete this interactive demo. It is a great way to learn about the special BioStack features offered with the LHC.

Keypad Control:

- The Quick Wash option does not function with the BioStack, i.e. the BioStack will not deliver a plate. You must create a protocol to process plates using the BioStack.
- You can use the Quick **Prime** option. This is recommended especially prior to processing plates, to remove air from the tubing.

■ Only one of the 405 LS's communication ports can be used at a time: you can plug in either the USB cable to connect it to the PC or the serial cable to connect it to the BioStack (but not to both at the same time).

Install and Align the BioStack:

1. Set up the BioStack according to instructions in your BioStack Operator's Manual to interact with the 405 LS. Connect it to the:
 - Host computer (PC) when using the LHC to control the 405 LS.
 - 405 LS when using the keypad to control the instrument.
2. Align the BioStack's gripper with the 405 LS's plate carrier:

LHC:	Keypad:
1. Select Tools> BioStack Utilities . 2. Use the Alignment Utility . Click the Help button for detailed instructions.	1. Press Setup Menu . 2. Select BIOSTK . 3. Select ALIGN .

3. Set the BioStack operating mode:

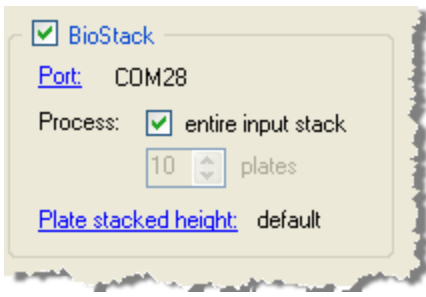
<p>LHC:</p> 	<p>Keypad:</p> <ol style="list-style-type: none"> 1. Press Setup Menu. 2. Select BIOSTK. 3. Select CONF. 4. Select BIOSTACK.
<p>Fill the BioStack checkbox in the main view to enable the BioStack action buttons and use them to design a protocol that delivers and retrieves plates.</p>	<p>Important: When using LHC to control the 405 LS and the BioStack, the instrument's BioStack configuration setting must be set to MANUAL, not "BIOSTACK."</p>

- To Restack or not? Yes: to keep plates in the same order. No: to save time when the plate sequence is unimportant.

5. **Verify** the setup: perform a protocol with 1 or 2 plates.

 At the start of the day, power up the BioStack first, and then the 405 LS. **BIOSTACK2WR**: Lift the BioStack's gripper before turning it on.

 Robotics integrators: CAD drawings of the physical dimensions of the 405 LS are available upon request. Contact BioTek customer service.



Technical Note: Only one of the two communication ports (COM port) on the instrument can be used at a time. They cannot be used simultaneously. You can use USB to connect the 405 LS to the computer or the RS232 serial port to connect to a BioStack or similar robotic device. But you cannot use both ports simultaneously, i.e. make sure only one cable is plugged in at a time.

Keypad Control: When the BioStack is connected to your 405 LS, you are controlling both instruments using the keypad. Before connecting the 405 LS to your computer to download basecode or for other reasons, you must first disconnect the BioStack from the 405 LS and change the Instrument Setting for the BioStack: Press **Setup Menu > BIOSTK > CONF > MANUAL**.

BioStack Alignment Utility

Follow the detailed procedure in the BioStack Operator's Manual to use this alignment utility to precisely align the BioStack's gripper with the microplate

carrier: First install the alignment hardware, correctly position the instruments in their respective aligning plates, and connect the instruments with the dedicated serial cable before attempting to align the gripper with the washer.

Begin by pressing **Home** to enable the alignment and step up and down buttons. When the gripper appears to be correctly positioned, Save (the) Position and proceed with the **Verify** procedure.

Press the previous button to exit the screen.

Cell Wash

- Not all 405 LS models support cell wash assays. The dual 96-tube wash manifold must be installed.

See how to **Define a Cell Wash Protocol on page 1**.

Low-flow Fluid Path

The 405 LS supports cell-based assays that require the addition and removal of buffer solution without disrupting the cells in the wells of the microplate. Cells are often dislodged when fluid is dispensed at too high a pressure and lost during subsequent aspiration of the fluid from the well unless counter measures are taken. The 405 LS is equipped with a low-flow fluid path that provides a "cell wash" alternative for cell-based assays.

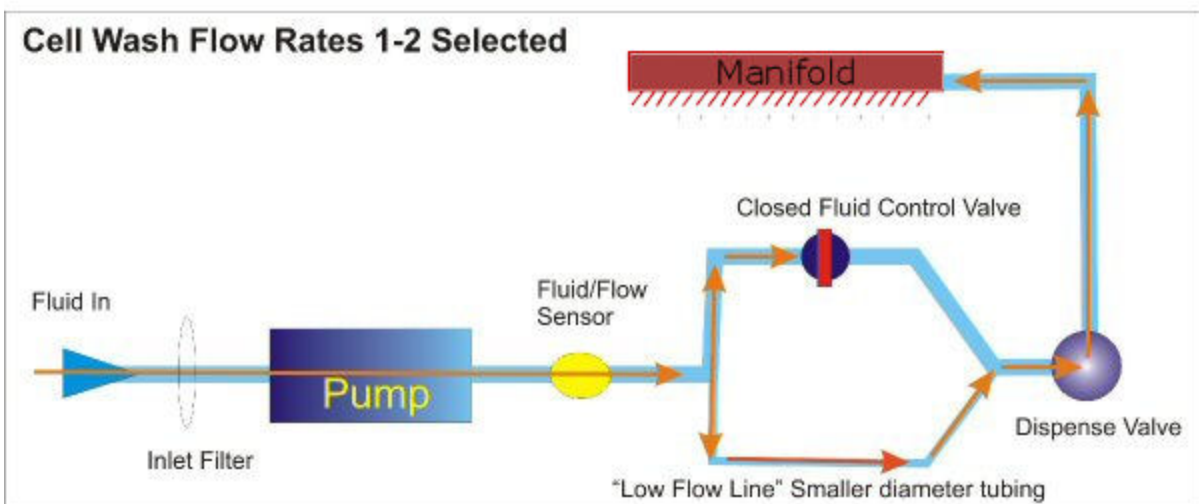
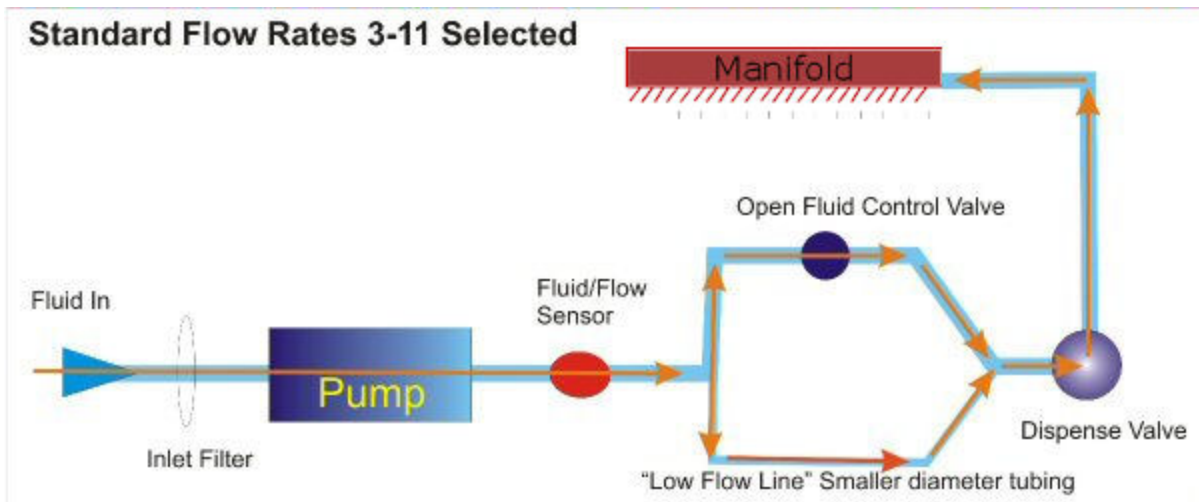

The low-flow tubing is used during a wash step when the Flow Rate is set to 1 or 2. It dispenses fluid to the wells slowly enough to avoid damaging the cells. Note that the low flow line is always open, i.e. some fluid flows through the tubing during normal dispenses. For this reason, priming the low flow tubing is recommended for all Prime steps.

Additional Techniques

Delay Aspiration: Also critical to cell-based assays is delaying aspiration to allow the slower dispense process to finish before beginning fluid removal from the well. This option, offered as part of the dispense step, is called [Delay Start of Vacuum](#).

Adjust the Aspirate Travel Rate and Aspirate Height: when defining the aspirate step select one of the specially designed travel rates that minimize turbulence in the wells. Increase the aspirate height to leave more residual fluid in the wells to protect the cell layer. Also, consider using a secondary aspiration as described in the Cell Wash Strategies described below.

Adjust the Dispense Flow Rate, Height and Position: when defining the dispense step be sure to select one of the special Flow Rates that trigger use of the low-flow tubing, 1 or 2 CW. Also reposition the dispense tubes to aim the fluid at the side of the wells to further minimize turbulence. [See Cell Wash Strategies below](#).

CW+ Dispense Manifold

As a result of BioTek's continuous improvement effort for liquid handlers, the washer dispense manifold has evolved. The dispense tubes of the improved manifold ensure fluid hits higher on the walls of the well, minimizing damage to the cells. "CW+ Dispense Manifold" is engraved on the top of these newer manifolds to make them easy to recognize. If you do **not** have one of these manifolds you may need to experiment with the Washer Settings on page 105 (the [CW+ Control](#)) to improve the performance of your cellular assays. [Contact BioTek](#) to obtain this special cell wash manifold.

Next: Define a Cell Wash Protocol on page 1.

Cell Wash Strategies

To give you a starting point for optimizing your own assays, here are some recommendations for improving your cell wash assays:

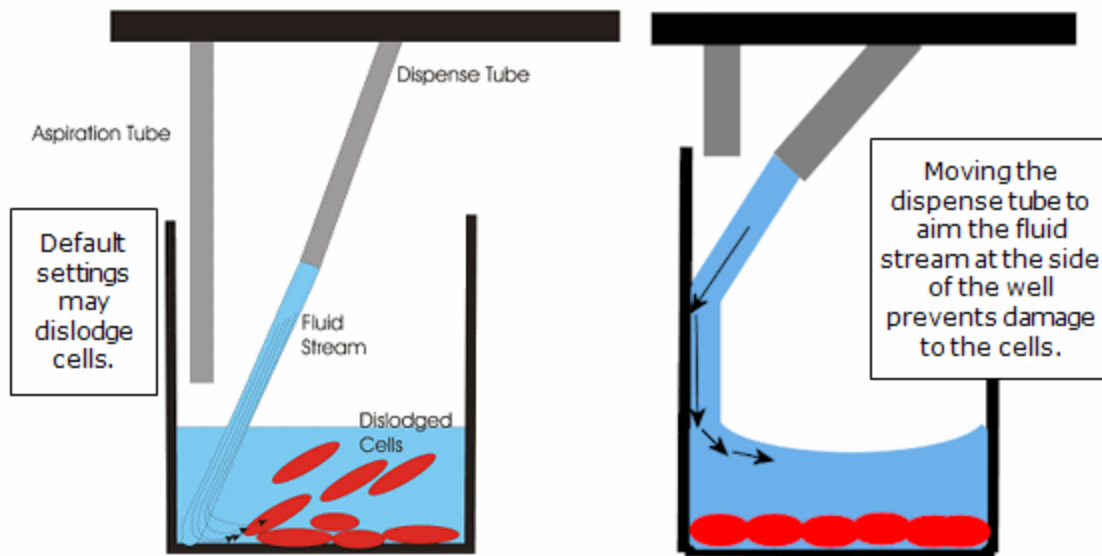

Repositioning the dispense and aspirate tubes helps minimize turbulence in the wells, preserving more cells. Using a standard 96-well Corning Costar plate, best results were achieved with these values:

Dispense Step Settings:
 Z - height = 120 steps
 X - horizontal position = -45
 Y - horizontal position = 0

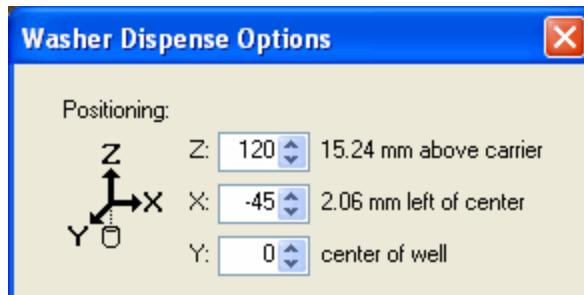

Aspirate Step Settings:
 Z = 46 steps
 X = 35
 Y = 0

Secondary Aspirate:
 Z = 80 steps
 X = -45
 Y = 0

About 40 μ L/well residual fluid is retained using these values.

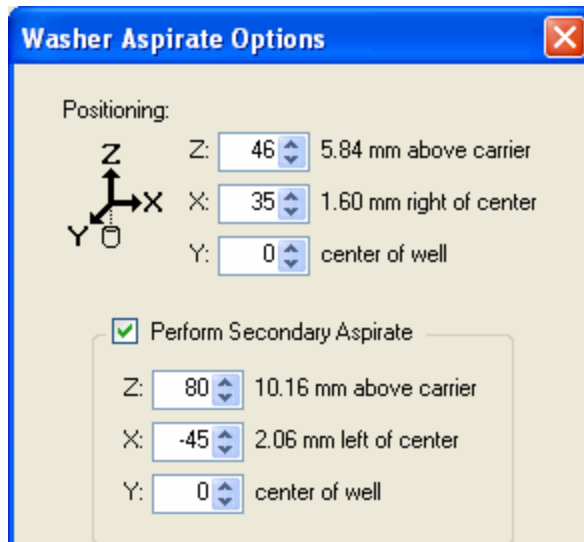

 For loosely adherent cells, the best performance was seen by increasing the aspirate height and using both a standard and secondary (or crosswise) aspiration. Moving the aspirate tubes from one side of the well to the other prevents a fluid stream from forming and dislodging the cells. Increased residual in the well means increased cell retention.

Best practice:

- Use the Align tool to determine the optimal X, Y, and Z axis adjustments needed to best position the manifold above the wells during the wash routine.
- Test the protocol settings by running the protocol using only water and an empty plate before actually running your assay to make sure the fluid stream hits the wells as desired.
- Optimal cell wash performance is achieved with BioTek's special CW+ Dispense Manifold. "CW+ Dispense Manifold" is engraved on the top of these newer manifolds to make them easy to recognize. If you do **not** have one of these manifolds you may need to experiment with the Washer Settings on page 105 (the **CW+ Control**) to improve the performance of your cellular assays. [Contact BioTek](#) to obtain this special cell wash manifold.

Delay Aspiration or Vacuum On Volume Control

LHC Users: Open the Wash or Dispense Step>Advanced Options

Delay start of Vacuum for cell washing until

Volume dispensed: $\mu\text{L}/\text{well}$

During regular plate washing, aspiration and dispensing occurs simultaneously. This allows "overflow" dispensing, because the fluid is aspirated before overflowing the plate. But, the low-flow tubing used in cell wash protocols dispenses fluid so slowly that aspiration must be delayed to allow the fluid to reach the well.

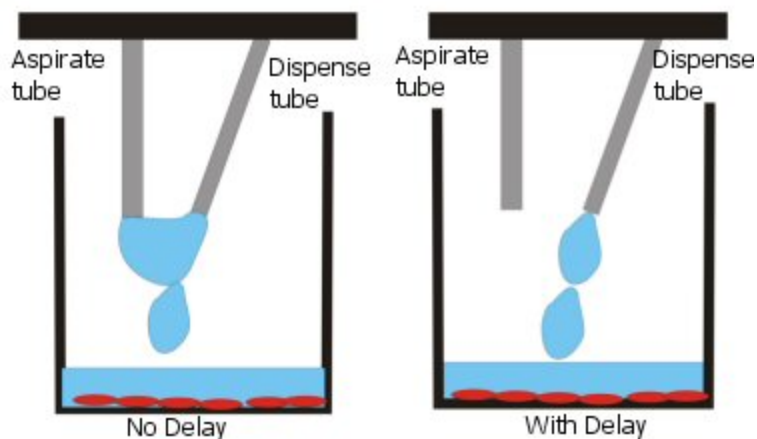

Use this control to turn on the vacuum pump and begin aspiration only after the specified volume is dispensed. For cell wash assays, specify at least 10 μL /well.

For small dispense volumes, BioTek recommends setting the vacuum-on volume to equal your dispense volume. Refer also to application notes on the BioTek web site for more information (www.biotek.com).

Biomagnetic Separation - Magnetic Bead Assays

The microplate carrier supports placement of a magnet under the microplate. The magnet induces magnetic beads to settle at the bottom of the wells to help retain them during a wash protocol's aspirate cycle.

The 405 LS supports standard microplates and these magnets available for purchase from BioTek:

Plate Type	Magnet	PN
96-well	96 Flat Magnet	7103016
	96 Ring Magnet	7102216
384-well	384 Flat Magnet	7103017
	384 Ring Magnet	7102215

You can use a different magnet if it fits in the carrier and accommodates your plates. Contact BioTek TAC or visit the Customer Resource Center at www.biotek.com to obtain a drawing of the carrier with its dimensions.

 **Persons with pacemakers/implants should avoid direct contact.** Keep all magnetic media, watches, and sensitive electronic devices away from the magnets. Credit cards, tapes, and disks can be erased in the presence of a magnetic field. Bodily harm [pinching of hands and skin] can result if magnets are not handled correctly. Maintain distance between two or more magnets.

 Take advantage of the sample magnetic-bead protocols shipped onboard the 405 LS. Copy W-Luminex_Mag_Flat_96, for example, and modify the parameters to suit your assay requirements.

Handling and Cleaning the Magnets

For best magnet strength and bead retention, the bottom of the microplate must be as close to the magnet as possible. We recommend using flat-bottom plates with minimal support “webbing” between the sides of the outer wells and the plate skirts.

Handle the magnets with care. Avoid direct contact with the magnet material. Keep loose ferrous material away and do not attempt to disassemble.

The magnet should be stored in a cool, dry environment and should be cleaned with a damp cloth and mild detergent when exposed to harsh solvents. Do not autoclave.

To install the magnet in the proper orientation:

- Flat magnet: place in the plate carrier so the text on the side of the magnet is readable;
- Ring magnet: place in the plate carrier with the small round magnets visible, facing upwards.

Realign the BioStack with the Magnet Installed

Using the magnet increases the effective height of the carrier surface (generally by at least 1 mm). This shift in the plate position requires a comparable adjustment to the BioStack's gripper movement. Realign the BioStack before using it with the magnetic bead assays.

Refer to the BioStack Operator's Manual for detailed instructions of the alignment procedure. To help get you started:

1. Place the magnet in the carrier and a microplate on top of it.
2. Launch the **BioStack Alignment Utility**:

LHC	Keypad
Tools> BioStack Utilities> Alignment Utility	SETUP >BIOSTK > ALIGN

3. HOME the BioStack and Begin Realignment.
4. Lower the claw until a 0.050" (1.3 mm) gap between the bottom of the plate and the top of the gripper fingers is achieved and save the gripper position.
5. Put the microplate in the input stack and Verify the alignment.



Remember to realign the BioStack for non-bead assays, when applicable.

Perform Magnetic Bead Assays

For the best results when performing biomagnetic separation assays:

- Use the Manifold Stop Screw Adjustment Kit on page 94, if necessary.
- Realign the BioStack with the Magnet Installed
- Change the Magnet Height Offset on page 93
- Optimize Magnetic Bead Protocols below

Optimize Magnetic Bead Protocols

Here are some suggestions to consider for optimizing your magnetic bead assays:

- **Plate Type:** Flat-bottom plates are recommended for magnetic bead assays because more of their well surface sits closer to the magnet, resulting in increased magnet strength, than with other plate formats. If you must use round-bottom plates, increase

the between-cycle soak time to improve bead separation during processing.

- **Shake/Soak Step:** Begin the protocol with a delay to let the magnetic beads settle. Also, specify a mid-cycle soak to let the beads settle after fluid is dispensed to the plate, e.g. include a 60 second soak before and between cycles.



Include a 1 second Shake in the first step to best position the plate.

- **6CW Aspirate Travel Rate:** select 6CW for the aspirate travel rate. The CW travel rates are designed to minimize disruption to cell layers on the bottom of the well. The same principle applies to magnetic bead assays.
- **Adjust the Aspirate height:** increase the aspirate height setting (Z-axis) which will increase the residual fluid in the wells but also preserve the beads. Good results were obtained when keeping the aspirate height around 1.0 mm above the plate carrier for all but a last Final Aspirate (disabled between cycles).
- **Adjust the Aspirate position:** When using Flat Magnets below, position the aspirate tubes near the sides of the wells (X-axis), if possible, to improve bead retention.
- As always, before running assays, we recommend testing new protocols using deionized or distilled water and a little Tween[®] 20 with the desired microplate and a magnet installed.

Flat Magnets

Use this information about the flat magnets to fine-tune wash protocol settings:

96F Magnet	7103016
384F Magnet	7103017

The 96- and 384-well magnets are structured differently. Their force fields traverse the magnet in opposite directions. Magnetic beads in the wells will be drawn to the center. For the best bead retention, reposition the aspirate tubes in the proper axis:

96-well Flat Magnet PN 7103016

The magnetic force (approx. 6800 Gauss) is distributed in a horizontal pattern, row-wise, across the plate. Magnetic beads are pulled to the center, across the well in flat-bottom plates and to the button in round-bottom plates. Increasing the aspirate height to increase the amount of residual in the well may improve performance.

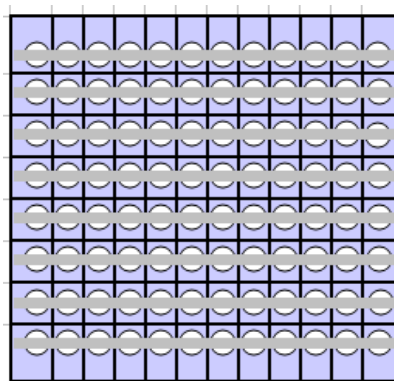

Aspirate Settings:

Adjust the Y Position to align the aspirate tubes near the well walls, if available. Increase the Aspirate Height (Z axis), leaving more residual volume in the wells.

**384-well Flat Magnet PN 7103017**

The magnetic force (approx. 4300 Gauss) is distributed in a vertical pattern, column-wise, across the plate.

Adjust the X Position to align the aspirate tubes away from the center of the well, near the well walls.

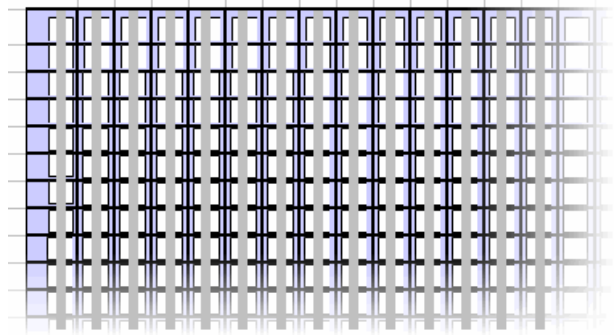

Ring Magnets

Use this information about the VP magnets to fine-tune wash protocol settings:

96 Ring Magnet	7102216
384 Ring Magnet	7102215

96 Ring Magnet

PN: 7102216

This magnetic bead separator uses 329 of VP's 52 MGO magnets (7094 Gauss). The magnets are arranged around each well, pulling the magnetic beads to the bottoms and edges of the wells. Aspirate from the center of the well (the default position), when using this magnet.

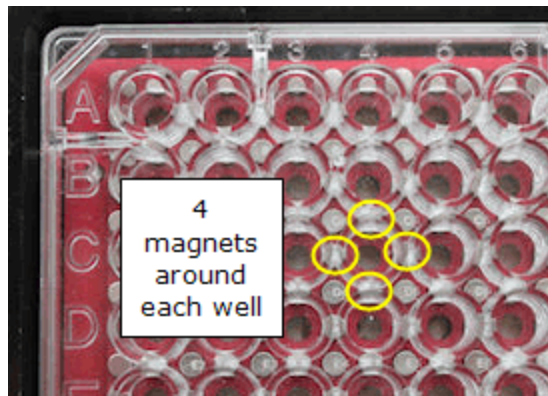
**384 Ring Magnet**

PN: 7102215

This magnetic bead separator uses 425 of VP's 52 MGO magnets (6994 Gauss). The magnets are aligned with the intersections of the wells, pulling the magnetic beads to the



Aspirate from the center of the well (the default position), when using this magnet.

bottoms and edges of the wells.
Every well is circled by 4 magnets.

Magnet Height Offset

When performing magnetic bead assays/biomagnetic separation, this offset setting is a real time saver. It increases the height or Z-axis for all processing options to accommodate the increased height of the plate when the magnet is installed.

This setting eliminates the need to modify individual protocol parameters to adjust the dispense and aspirate heights and enables Quick Wash (without adjustments) when the magnet is used. It applies the specified height value as an offset to all relevant steps.

 Custom or non-standard microplates and special adapters for labware may benefit from this setting, too. If a vessel's height has been its only limitation to processing with the 405 LS, i.e. the vessel's geometry permits the manifold tips to successfully address its wells, this setting can be used to simplify protocol development.

See Determine Magnet Height Offset below.

 For the best results, measure the height of the plate you are using with the magnet. BioTek has determined that Nunc flat bottom plates are about 3 mm taller than a similar Corning plate, for example.

The "In use" checkbox/option lets you specify and retain a height setting. Set the value once and then use the control to switch it on and off: fill the checkbox (keypad users: say Yes) when using a magnet, empty the checkbox (keypad: No) to disable the offset.

LHC	Keypad
<ol style="list-style-type: none"> Tools> Instrument Utilities> General Fill the In use checkbox and set the Magnet Adapter height to the correct offset. Click the Send link. 	<ol style="list-style-type: none"> SETUP > MAGNET Select YES. Enter the desired offset value and press Enter.

Determine Magnet Height Offset

Use a caliper for the best results or another measuring device.

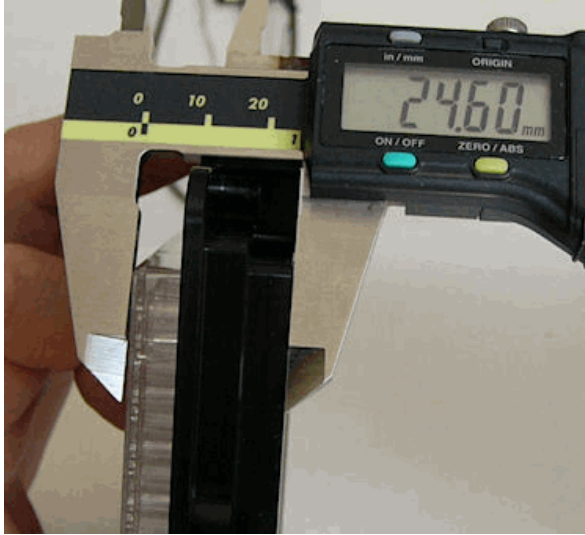

1. Measure the combined height of the plate, magnet, and carrier in millimeters.
2. Measure the plate and the carrier.
3. Calculate the offset: (plate + magnet + carrier) - (plate + carrier) = Magnet Height Offset

1. Remove the carrier from the washer.
2. Put a magnet in the carrier and the type of plate you will be using on top of it.
3. Measure the distance from the bottom of the carrier to the top of the plate in millimeters (mm).
4. Remove the magnet, and measure the plate and carrier combined.
5. Subtract the plate and carrier measurement from the measurement value of the total combined elements. This is the offset value to use.

Example:

$$\begin{aligned} 24.6 \text{ mm} &= 96\text{-well Corning microplate} + 96\text{-well flat magnet} + \text{plate carrier} \\ - 22.7 \text{ mm} &= \underline{96\text{-well Corning microplate and plate carrier}} \\ 1.9 \text{ mm} &= \text{Magnet Height Offset} \end{aligned}$$

Manifold Stop Screw Adjustment Kit

For Magnetic Bead Assays and 384-Well PCR Plate Processing

To successfully perform these assays, 405 LS Select and HT models may need to adjust the height of the manifold stop screw. The adjustment kit, PN 1170011, is shipped with instruments with a dual manifold.

The manifold stop screw prevents the bottom manifold from touching the microplate during operation. Sometimes the screw installed at the factory is too tall or too short to permit desired processing:

- a taller screw is needed to support a magnet under the plate for magnetic bead assays
- a shorter screw is needed to support processing of 384-well PCR plates that have a very low profile

Two stop screws can reside in the plate carrier, making it easier to swap between them.

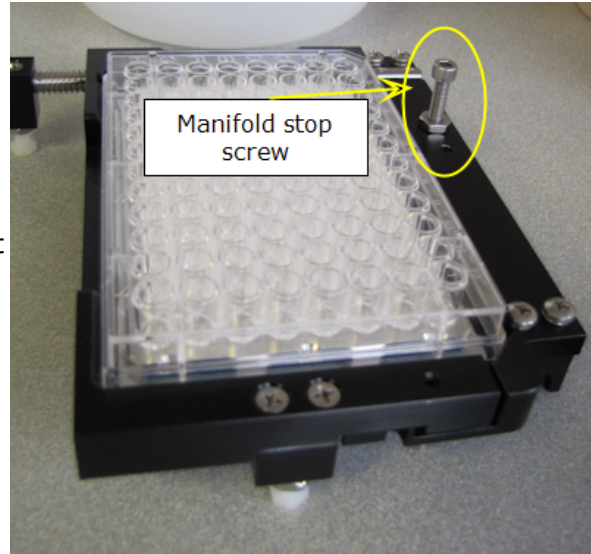

Microplate Carrier

Kit Contents:

- Screw height measurement tool (jig)
- Two stop screws with adjustable nuts and lock washer
- 5/32" Allen (hex) wrench
- Two wrenches - 5/16" and 3/8"

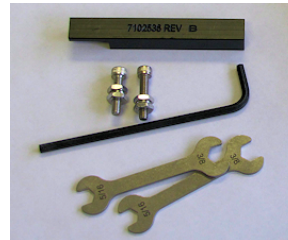

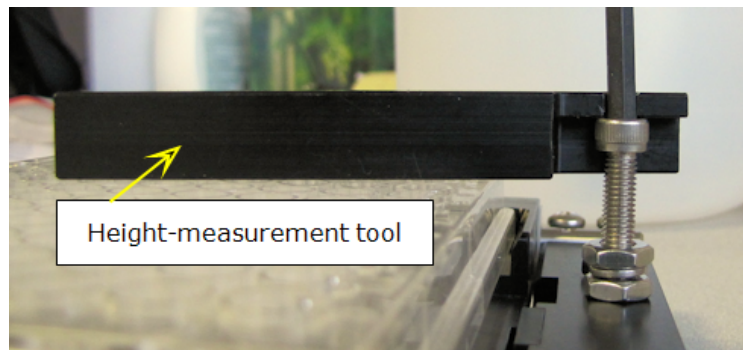

 Remove the carrier to perform most of these steps but always perform the measurement steps with the plate carrier installed correctly on the 405 LS.

1. In the carrier's empty hole, insert the taller stop screw when using a magnet or the shorter screw when using PCR plates.
2. Put the magnet and microplate or the 384-PCR plate in the carrier on the instrument. Place the height-measurement tool (or jig) on top of the microplate, with the notched end above the screw.

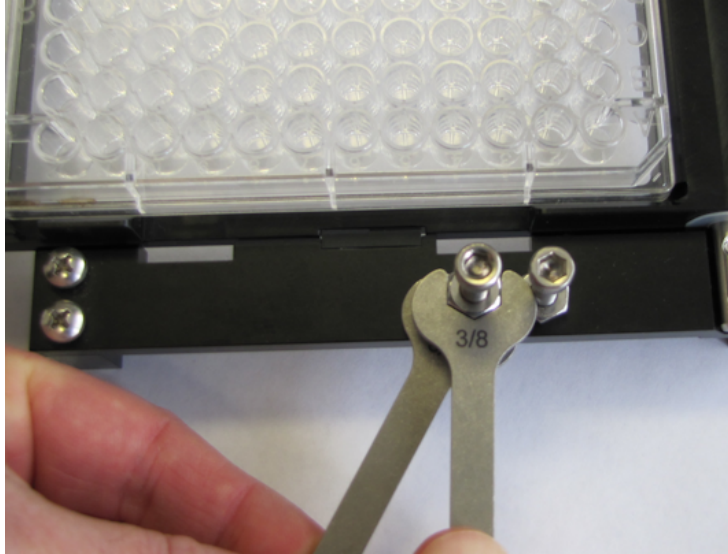

3. Hold the jig level on top of the microplate and raise or lower the stop screw so its head touches the bottom of the notch.
4. Set the jig aside. Using your fingers, hold the stop screw in place and screw the bottom nut down until it touches the microplate carrier.
5. Using the two supplied wrenches, tighten the bottom nut to secure the screw, then tighten the top nut to fully compress the washer between them. This will lock the nuts in place and allow you to easily remove/replace the screw without affecting its height setting.
6. Verify the height with the jig and repeat steps 3-6 if necessary.



 Instrument Settings: Try applying different [Plate Clearance](#) and [Magnet Height Offset](#) settings to optimize performance with special plates, like 384-PCR.

Vacuum Filtration for Filter Plate Assays

With the optional vacuum filtration accessory kit, you can process most standard-size filter-bottom microplates.

To perform filter plate assays:

- Install the side bracket on next page

■ Follow instructions provided with the accessory kit.

- Set up the Vacuum Filtration module
- Install Vacuum Filtration Plate Carrier on page 103
- Create a Vacuum Filtration Protocol on page 101

Maintenance guidelines: Maintaining the Vacuum Filtration System on page 133

■ For the best results, take a few moments to learn how to Control the Vacuum Level on page 104.



Take advantage of the sample vacuum filtration protocols shipped onboard the 405 LS. Copy W-Luminex_Vac_96, for example, and modify the parameters to suit your assay requirements.

Recommendations for best performance:

Here are some guidelines to achieve the best performance of your filter plate assays:

- Do not use dry filter plates. If dry plates are required by the assay kit instructions, turn off the Vacuum Filtration sensor to avoid process interruptions.
- Shake the plate to suspend the beads before aspiration. Enable the wash cycle option to shake the plate after the dispense and before aspiration. Also consider creating a multi-step protocol that begins by shaking the plate.
- Experiment with the two parameters, aspiration time and vacuum level, to determine the best combination of settings for your assay. Start with a brief time period and low vacuum to avoid lodging the beads in the filter material.
- Maintain consistent vacuum during the process with a tight seal:
 - Use new or defect-free filter plates and make sure they are seated perfectly in the carrier;
 - Make sure all tubing is connected correctly, and leak-free.

Expect to spend some time experimenting with different pressure settings. Follow the filter plate manufacturer's recommendations, if available. Generally, bead assays prefer low pressure and DNA separation assays prefer higher pressure. The best performance in tests at BioTek were seen when the pressure was set to 2.5 inHg.

Install the side bracket

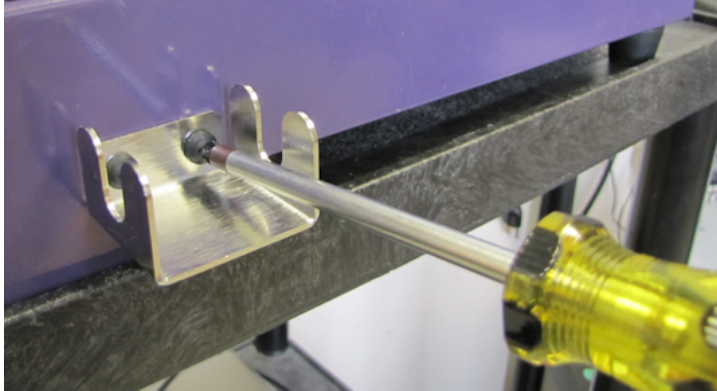

Install the bracket on the right side of the washer to hold the vacuum filtration tubing used to evacuate the filter plate.

Locate the screws shipped with the bracket

Required: Philips screwdriver

1. Locate the two empty holes on the right side of the washer and line up the bracket over the holes.
2. Insert the screws using the Philips head screwdriver.

Set up the Vacuum Filtration module

Connect the Intermediate Waste System

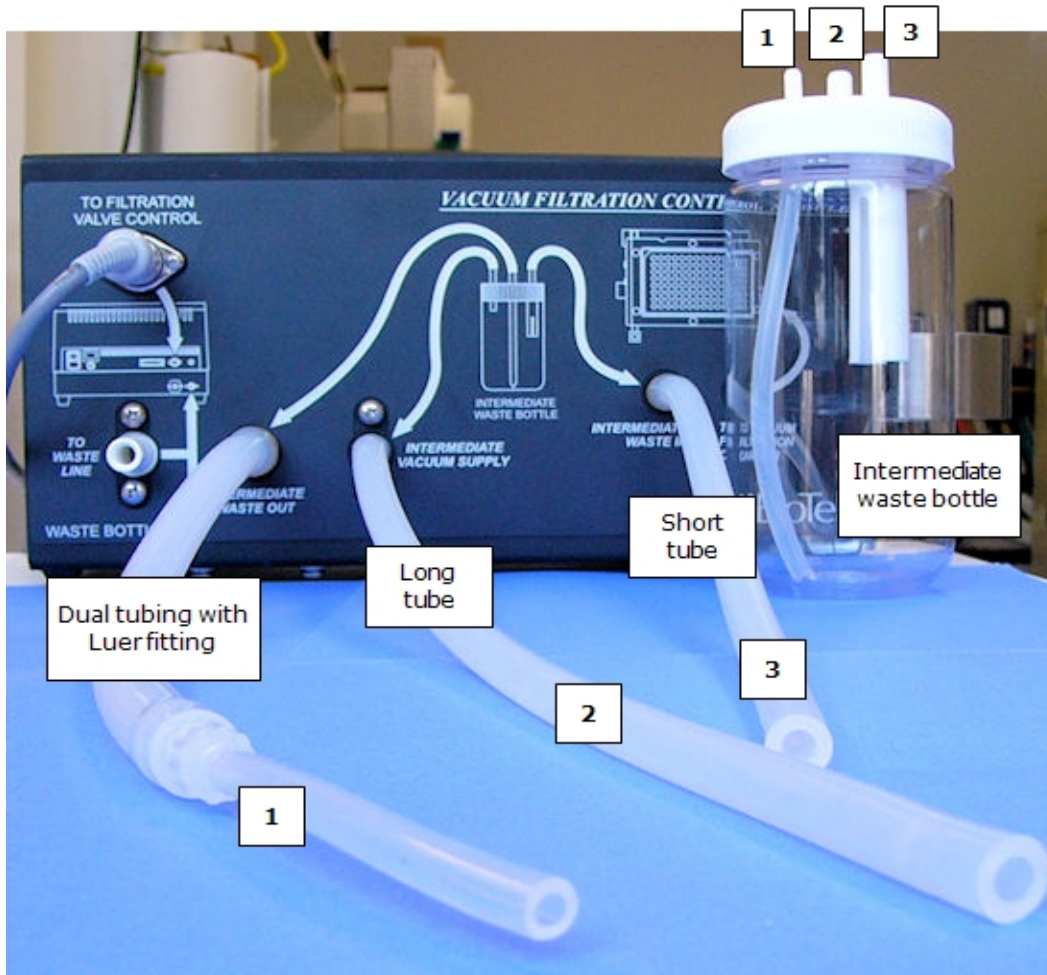

Intermediate Waste System Setup

For this step you will need the **Vacuum Filtration** tubing, intermediate waste bottle, and the control module. Review the tubing map on the front of the control module. It is a good guide for this step.

Three lengths of tubing are supplied to set up the control module. Connect the tubing to the control module and to the intermediate waste bottle cap:

	Tubing	Control Module	Waste Bottle Cap
1	Dual tubing connected by Luer fitting, approx. 15"/38.1 cm	Intermediate Waste Out	Smallest nipple with long interior tube
2	Long single tube, approx. 15"/38.1 cm	Intermediate Vacuum Supply	Nipple without a tube inside the bottle

	Tubing	Control Module	Waste Bottle Cap
3	Short single tube, approx. 12"/30.48 cm	Intermediate Waste In	Nipple with the wide, split-tube extension in the bottle

■ Two other quite distinct tubing sets are used in subsequent steps.

1. Put the intermediate waste bottle into the bracket on the side of the control module.
2. Connect the tubing with the Luer fitting to the port labeled **Intermediate Waste Out** and to the smallest nipple on the waste bottle cap.
3. Connect the longest single tube to the port labeled **Intermediate Vacuum Supply** and to the nipple without a tube inside the bottle.
4. Connect the shortest tube to the port labeled **Intermediate Waste In** and to the waste bottle cap nipple with the wide, split-tube extension inside the bottle.

Connect to Waste System

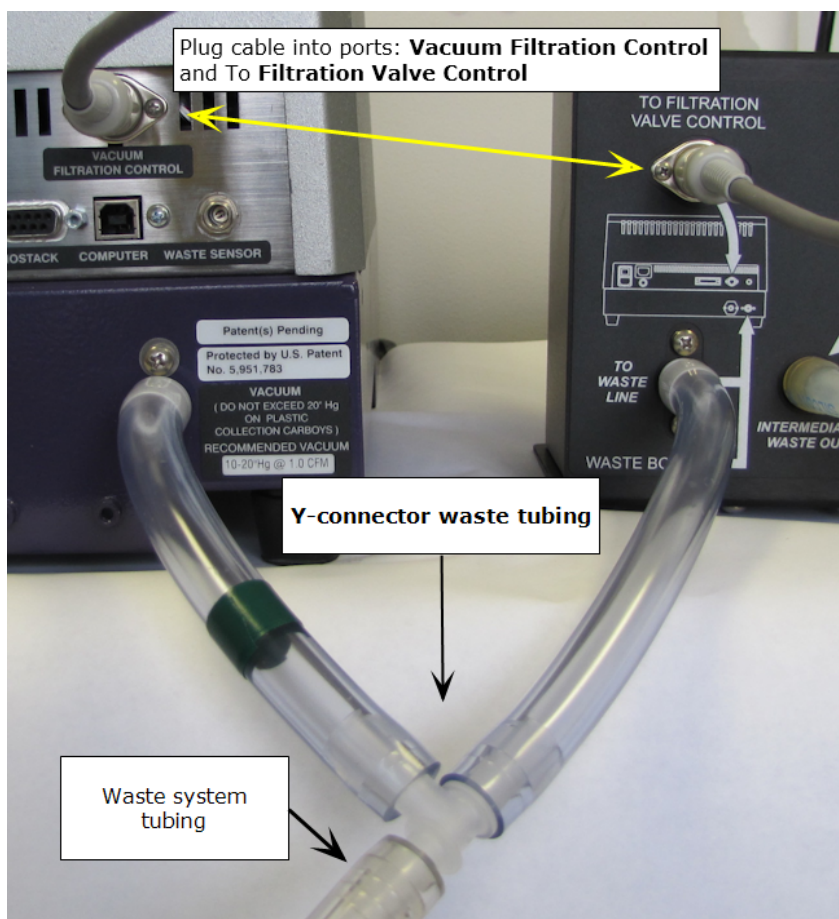

Connecting the Vacuum Filtration module to the washer

This step requires the Y-connector waste tubing which is provided to connect the control module to the washer’s main waste system.

1. Remove the main waste system tubing from the **Vacuum** port on the back of the washer (waste tube with green bands on both ends), if it is installed. Plug it into the barbed fitting of the **Y-connector** waste tubing.
2. Connect the branch of the **Y-connector** that does not have a green band (tube with no tape) to the control module port labeled **To Waste Line**.
3. Connect the other end of the **Y-connector** (with green band), to the **Vacuum** port on the back of the washer.

Connect the Vacuum Filtration Control Module to the Washer



Connect the supplied cable from the round port labeled **To Filtration Valve Control** on the control module to the corresponding **Vacuum Filtration Control** port on the back of the instrument.

Enable Vacuum Filtration

LHC	405 LS Keypad
<ol style="list-style-type: none"> 1. Select Tools>Instrument Utilities>Washer 2. Select installed for the Vacuum Filtration Module. 	<ol style="list-style-type: none"> 1. Press Setup Menu. 2. Select →>ADVANC>VACFIL. 3. Select Yes for Vacuum Filtration Module.

Create a Vacuum Filtration Protocol

 You may want to begin the protocol with a Shake step to suspend the beads.

LHC:	Keypad:
<ol style="list-style-type: none"> 1. Click  (or select File>New). 2. Select the plate type. 3. Specify a Protocol Name. 4. Click  5. Click Show Wash Options 6. Fill the checkbox for Vacuum Filtration 	<ol style="list-style-type: none"> 1. At the main menu, select DEFINE>CREATE and assign a unique name to the protocol. 2. Select the plate type. 3. Select ADD>WASH 4. Select ASPIR>VAC 5. Specify the duration to apply

LHC:

and specify the vacuum duration, **Time**.
Optionally, do the same for the **Final Aspirate**.

7. Fill the checkbox for **Shake/Soak** and specify the shake duration.

Keypad:

vacuum.

6. Select **OPTS>MIDCYC** and add a **Shake** duration to follow each dispense to suspend the beads before applying the vacuum.
7. Select **OPTS>POST** to either disable the **Final Aspirate** or make sure it is defined for vacuum filtration.
8. Experiment with other parameters, like number of cycles, to optimize the protocol for your assay.

Experiment with different settings to determine the optimal parameters to meet your goals.

- Important: Be sure to [change the Plate Carrier setting](#) to match the installed carrier.



Remember to specify the type of aspiration to perform in a **Final Aspirate**. Keypad users: select **OPTS>POST** at the Wash Step Parameters menu.

Install Vacuum Filtration Plate Carrier

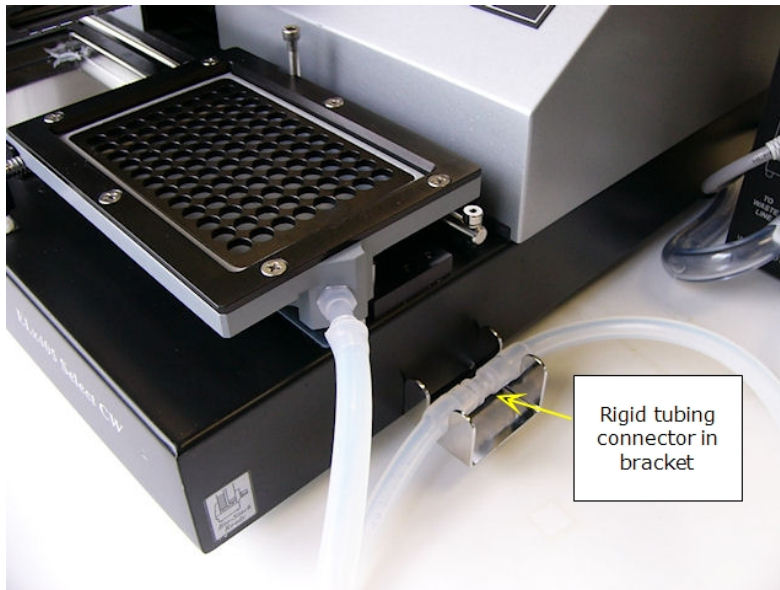

Vacuum Filtration Plate Carrier (and bracket for holding tubing)

1. Locate the longest length of tubing shipped with the module. It is made from two tubes joined by a rigid connector.
2. Connect the shorter end to the special plate carrier for vacuum filtration.
3. Connect the longer end to the control module port labeled **To Vacuum Filtration Carrier**.
4. Tuck the rigid connector into the bracket you installed on the side of the instrument.
5. Change the instrument setting:

LHC	Keypad
<ol style="list-style-type: none"> 1. Select Tools > Instrument Utilities. 2. For Plate Carrier Selection, select Vacuum Filtration. 	<ol style="list-style-type: none"> 1. Press Setup Menu > MORE > CARR 2. Select VAC.

Note: Make sure Vacuum Filtration is "enabled" to select the special plate carrier: **Setup Menu > → > ADVANC > VACFIL**

Important: Always set the carrier selection to match the installed hardware, regardless of the type of plate processing you are doing. You can perform a regular wash (non-filter plates) using the vacuum filtration carrier.

Control the Vacuum Level

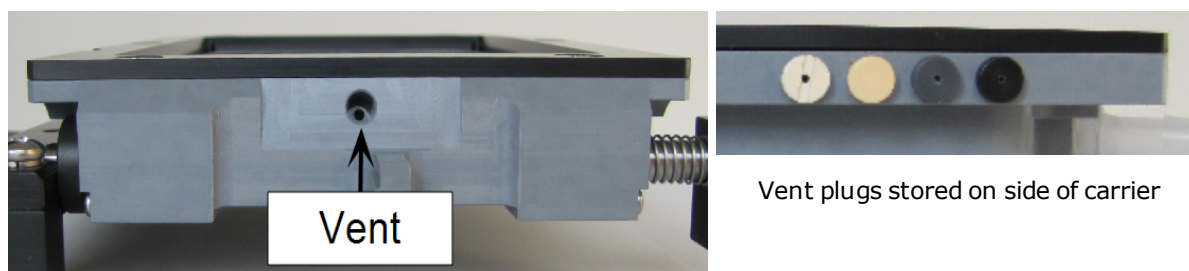
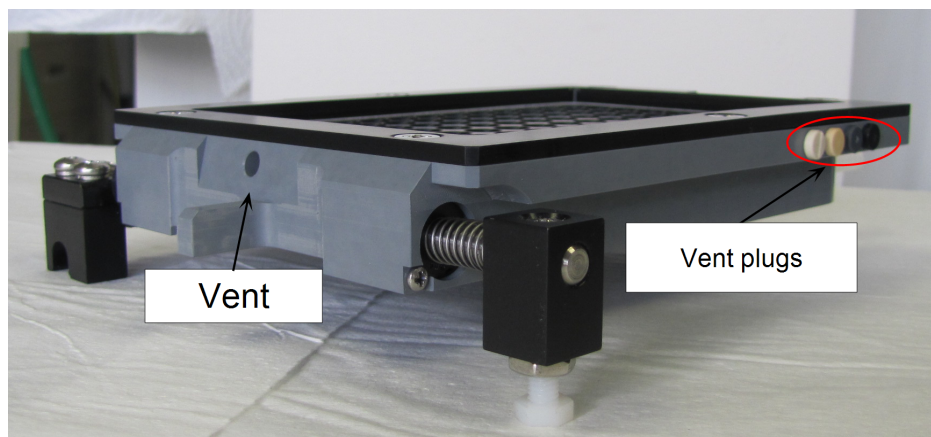

Change the vent plug to control the vacuum level

The vacuum filtration plate carrier has a vent and ships with four vent plugs to vary the vacuum levels:

Plug	Vent Diameter	Vacuum Level	mmHg	kPa
No plug	0.067" (1.70 mm)	Lowest	-32	-4.3
Beige with hole	0.047" (1.19 mm)	Low	-118	-15.7
Gray	0.032" (0.81 mm)	Medium	-187	-24.9
Black	0.020 (0.51 mm)	High	-382	-50.9
Beige (solid)	0.00	Highest	-567	-75.5

Leave the vent open for the least amount of vacuum. Insert one of the plugs to increase vacuum.

- Vacuum pressure is affected by several factors like relative humidity, barometric pressure, and mechanical tolerances, as well as, filter plate pore size

Testing at BioTek confirmed expectations: small pore filter plates and highly viscous fluids require increased vacuum and/or longer aspiration durations to evacuate the wells.

Here are the results of our tests using 25% horse serum to give you a starting point for your experimentation.

Plate and Dispense Volume	Vent Plug	Aspiration Time
Millipore 96-well 0.45µM filter plate; 200 µL/well sample volume	Beige w/hole	12.9 sec
	Gray	8.8 sec
	Black	7.1 sec
	Beige	6.4 sec
Millipore 96-well 1.2 µM filter plate; 200 µL/well sample volume	Beige w/hole	6.2 sec
	Gray	4.7 sec
	Black	4.6 sec
	Beige	3.9 sec
Millipore 384-well 1.2 µM filter plate; 100 µL/well sample volume	Beige w/hole	8.9 sec
	Gray	6.5 sec
	Black	6.0 sec
	Beige	4.7 sec

Washer Settings

Touch screen: Instrument>Options

LHC users: Tools>Instrument Utilities>Washer

Manifold Selection

After physically changing the manifold, tell the 405 LS which manifold is installed:

- **96-tube:** single manifold for 96-well plates only or dual manifolds to process 96- and 384-well plates.
- **192-tube:** only 384-well plates.

Magnet Height Offset

When performing magnetic bead assays/biomagnetic separation, this offset setting is a real time saver. It increases the height or Z-axis for all processing options to accommodate the increased height of the plate when the magnet is installed.

This setting eliminates the need to modify individual protocol parameters to adjust the dispense and aspirate heights and enables Quick Wash (without adjustments) when the magnet is used. It applies the specified height value as an offset to all relevant steps.



Custom or non-standard microplates and special adapters for labware may benefit from this setting, too. If a vessel's height has been its only limitation to processing with the 405 LS, i.e. the vessel's geometry permits the manifold tips to successfully address its wells, this setting can be used to simplify protocol development.

See Determine Magnet Height Offset on page 93.

In use - this checkbox lets you retain the height offset value while turning off its application. After determining the offset, enter the **Height** value, fill the checkbox to apply the Magnet Height Offset. Conversely, empty the checkbox to disable the offset. LHC users: don't forget to click **Send** to apply the change.

Sensors Enabled

- **Important:** The washer must be primed, tubes filled, prior to a run.
- These sensors cannot detect the depletion of fluid in the supply vessel during a protocol step. Fill the supply bottle(s) with sufficient fluid to fully prime the system and complete the protocol.
- Fluid Detection:** measures the fluid level at the beginning and completion of a wash cycle, dispense and AutoClean step. An error before the run suggests insufficient fluid to begin. An error at the end of the run may indicate that less volume than specified was dispensed.
- Flow Detection:** monitors fluid flow during the run and issues a warning if the pump is interrupted. An error indicates a problem with the pump.
- Filter Vacuum Detection:** built into the vacuum filtration module, this sensor detects errors in the setup of the vacuum filtration system, including disconnected tubing, loose bottle cap, missing filter plate, non-functioning internal vacuum pump and extremely low vacuum. This sensor is disabled by default.
- Plate Detection:** washers with Verify™ Technology offer this sensor to detect the presence of a microplate on the plate carrier before every protocol run. BioStack users: the sensor checks for the first plate in the stack only.

BioTek recommends keeping the detection systems activated. Exceptions:

- Deactivate the Waste sensor when using BioTek's Direct Drain Waste System.
- When vacuum filtration assays need to be performed at very low vacuum levels, e.g. no plug, but the washer displays an error, deactivate the sensor: LHC - "Filter Vacuum" or Keypad - "Vac Fil".
- When running the system using air instead of fluid to dry out the components before shipping or long-term storage, if error messages interrupt the procedure, deactivate the fluid and flow sensors.

CW+ Control

This setting is applicable only to cell wash assays that use dispense flow rates 1 CW and 2 CW. Generally, the optimal instrument configuration for cell wash assays includes installation of the [CW+ Dispense Manifold](#) and enabling this control with the default 100 msec setting. If the CW+ Dispense manifold is not installed, better performance may be achieved by disabling this setting. Additionally, a minor adjustment to the duration setting may improve the performance of certain instruments.

Service Functions

Position the wash manifold to install the [shipping bracket](#): prior to packing up the instrument, click the link and install the manifold shipping bracket.

Change the Washer Manifold Setting (Keypad)

The instrument's onboard settings must match the installed hardware.

If you have multiple wash manifolds, in addition to physically changing the manifold (Remove/Change Wash Manifold on page 145), you must also change the instrument manifold setting:

1. Press **Setup Menu** (button in center of keypad).
2. Select **→** and then **MANIF**.
3. Select the currently installed wash manifold by pressing its Soft-key: Single or Dual 96-tube or 192-tube manifold.

Change the Plate Carrier Setting (Keypad)

The instrument's onboard settings must match the installed hardware.

When you physically change the plate carrier to perform special assays, you must also change the instrument carrier setting to direct the devices to higher or lower positions to accurately address the wells:

1. Press **Setup Menu** (button in center of keypad).
2. Select **→** and then **CARR**.
3. Select the currently installed carrier by pressing its Soft-key:
 - STD - Standard (Magnet Ready) carrier
 - VAC - Vacuum filtration carrier.

Change the Plate Clearance Setting (Keypad)

The Plate Clearance setting adds the specified (input) value to the travel height for the selected [plate type](#), i.e. it adds this number to the "Plate Height" value cited in the Plate Types Table. The manifold rises to this height to move from one column to the next and whenever repositioning is needed. This setting does not affect dispense and aspirate heights.

Use this setting to accommodate plates that are slightly taller than standard plates to make sure the manifold rises high enough above the plate to prevent crashes when the plate carrier moves.

Note: Enabling the [Magnet Height Offset](#) affects the travel height, as well as dispense and aspirate heights. The Magnet Height [Offset](#) increases the respective values of all height parameters. Generally, it is best to keep the default setting for Plate Clearance when using the Magnet Height [Offset](#) setting.

To change the setting using the keypad:

1. Press **Setup Menu** (button in center of keypad).
2. Select **→** and **ADVANC** then **PLTCLR**.
3. Enter an offset value in millimeters (mm).

Adjust Utility

LHC: Tools>Instrument Utilities>General Information

Keypad: Select UTILS>ADJST from the main menu

The **Adjust Utility** is a tool for determining the precise positioning of the dispense and aspirate tubes when addressing the plate. Generally, the components' default positions function perfectly, but certain assays may be improved by repositioning the dispense or aspirate tubes. For example, to minimize cell damage, tubes can be positioned at the sides of the wells, rather than the center. Use the utility to identify the offsets required, then, enter these offsets when defining the protocol step.

The Adjust Utility puts the plate in its run position and lets you position the plate in relation to the manifold. You can:

- Raise or lower the manifold in the Z-axis, to determine the optimal dispense or aspirate height, for example. The default positions are based on the plate type.
- Position the tubes in the X and Y axes by moving the plate carrier. The default position is the center of the well, 0 steps:
 - Move the carrier left or right in the X-axis. Negative offsets move left of center; positive offsets are right of center.
 - Move the carrier forward and back in the Y-axis. Negative offsets move the plate backward from center; positive offsets place the plate forward of center.

 **Warning:** The Adjust Utility does not have limits to protect you from making bad choices. It is possible to identify dispense positions that miss the wells, for example. If incorrect values are defined in the protocol, you'll have a big mess on your hands.

Positional Limits:

The allowable ranges for positioning the devices for operation:

	X	Y	Z
Washer	-60 to 60 steps 2.74 mm offset	-40 to 40 2.96 mm offset	1 to 210 steps 26.68 mm max

Run the Adjust Utility (Using the Keypad)

This page describes how to run the Adjust Utility using the keypad rather than the LHC. Find LHC instructions in the Help system.

- Learn about the **Adjust Utility on previous page.**
 - Keep in mind the positional limits of the devices during operation.
1. Place a microplate on the carrier.
 2. Select **UTILS** at the main menu and then select **ADJST**.
 3. Select the PLATE TYPE. Only valid options for the installed hardware are presented for selection.
 5. Select a run position. Only one position may be viewed at a time.
 - for the Washer choose **ASPIR** (aspiration) or **DISP** (dispense) depending on which tubes you are measuring offsets for;
 6. At the **AXIS** screen, choose an axis, Z, X or Y. The top line of the display indicates which axis is active, and the offset position of that axis:

Axis	Washer	
Z-axis (up/down)	MAN	Positions the manifold or dispense arm.
X-axis (left/right)	CARX	Positions the plate carrier.
Y-axis (front/back)	CARY	Positions the plate carrier.

7. Closely observe the position of the hardware. Use arrow keys: ◀ (reverse) and ▶ (forward) to single-step the offset in either direction.
8. When the desired offset position is found, record the position number to enter later when defining a wash, dispense, or aspirate step.
9. To quit the Adjust Utility, press Main Menu. The carrier and manifolds return to their default positions.

Plate Types and Processing Patterns

Depending on the type of hardware installed on the instrument, e.g. manifold type, the 405 LS can process several plate types. The default parameters for wash and dispense steps represent the optimal positioning of the hardware for the plate type. And, the aspirate and dispense heights and horizontal positions can be adjusted when necessary for special situations and to optimize assay performance.

- Review the Plate Types Table on the facing page for a listing of supported plates and their geometries;
- **See [About Wash Processing Patterns on the facing page](#)** in the Help system or operator's manual.
- See **Dispense Processing Patterns** in the Help system or operator's manual.
- Review these instrument settings that may improve your work flow:
 - Plate Carrier Setting
 - Plate Clearance Setting
 - Peri-pump Dispense Pattern

Plate Types Table

Plate Type	Columns x Rows	Plate Height	Default Aspirate/Dispense Heights
		mm	Washer
96 Well	12x8	14.35	29/121
384 Well	24x16	14.22	22/120
384 PCR ²	24x16	9.50	2/83

² Low profile 384 PCR plates require manually adjusting the height of the manifold stop screw.

Plate Geometry Diagram

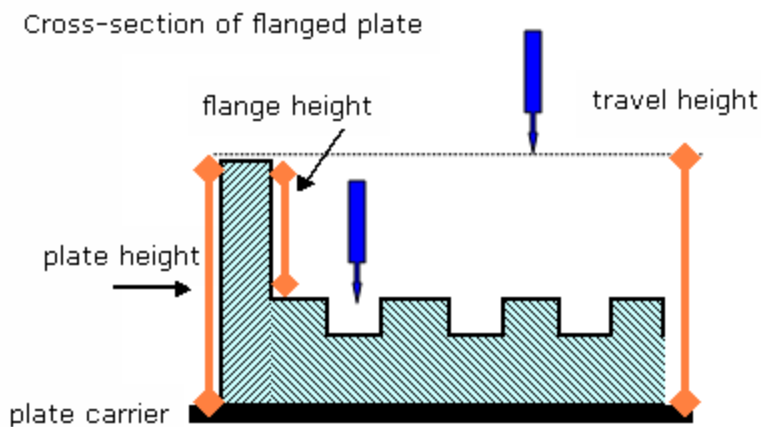

Plate height = physical measurement

Default Dispense Height = (plate height - flange height + 1.0 mm)

Travel Height = (plate height - flange height + [Plate Clearance](#))

- If Dispense Height > Travel Height (greater than), the travel height is changed to match the dispense height.

About Wash Processing Patterns

When using a 96-tube manifold to process a 96-well plate, all wells are processed simultaneously. To process 384-well plates, a processing pattern is needed, which also provides the ability to process the plate partially. Some portions of the plate

can be left untouched or panels can be defined, i.e. multiple assays can be run on the same plate.

The processing pattern is determined by the hardware's footprint.

96-tube wash pattern for 384-well plate

	1	2	3	4	5	6	7	8	9	10	11	12	13	14	15	16	17	18	19	20	21	22	23	24
A	A	B	A	B	A	B	A	B	A	B	A	B	A	B	A	B	A	B	A	B	A	B	A	B
B	C	D	C	D	C	D	C	D	C	D	C	D	C	D	C	D	C	D	C	D	C	D	C	D
C	A	B	A	B	A	B	A	B	A	B	A	B	A	B	A	B	A	B	A	B	A	B	A	B
D	C	D	C	D	C	D	C	D	C	D	C	D	C	D	C	D	C	D	C	D	C	D	C	D
E	A	B	A	B	A	B	A	B	A	B	A	B	A	B	A	B	A	B	A	B	A	B	A	B
F	C	D	C	D	C	D	C	D	C	D	C	D	C	D	C	D	C	D	C	D	C	D	C	D
G	A	B	A	B	A	B	A	B	A	B	A	B	A	B	A	B	A	B	A	B	A	B	A	B
H	C	D	C	D	C	D	C	D	C	D	C	D	C	D	C	D	C	D	C	D	C	D	C	D
I	A	B	A	B	A	B	A	B	A	B	A	B	A	B	A	B	A	B	A	B	A	B	A	B
J	C	D	C	D	C	D	C	D	C	D	C	D	C	D	C	D	C	D	C	D	C	D	C	D
K	A	B	A	B	A	B	A	B	A	B	A	B	A	B	A	B	A	B	A	B	A	B	A	B
L	C	D	C	D	C	D	C	D	C	D	C	D	C	D	C	D	C	D	C	D	C	D	C	D
M	A	B	A	B	A	B	A	B	A	B	A	B	A	B	A	B	A	B	A	B	A	B	A	B
N	C	D	C	D	C	D	C	D	C	D	C	D	C	D	C	D	C	D	C	D	C	D	C	D
O	A	B	A	B	A	B	A	B	A	B	A	B	A	B	A	B	A	B	A	B	A	B	A	B
P	C	D	C	D	C	D	C	D	C	D	C	D	C	D	C	D	C	D	C	D	C	D	C	D

To process a partial plate, you must select the sector or sectors you want to process:

- Keypad users see: Define the Plate Type and Plate Map or Partial Plate on page 50 for instructions.

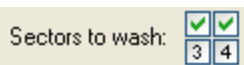

Checkmarks show the sectors to be processed. Numbers show potential sectors that are currently unselected and will not be washed. The 96-tube manifold processes the plate in four sectors.

A	B
C	D

192-tube wash pattern for 384-well plate

	1	2	3	4	5	6	7	8	9	10	11	12	13	14	15	16	17	18	19	20	21	22	23	24
A	A	B	A	B	A	B	A	B	A	B	A	B	A	B	A	B	A	B	A	B	A	B	A	B
B	A	B	A	B	A	B	A	B	A	B	A	B	A	B	A	B	A	B	A	B	A	B	A	B
C	A	B	A	B	A	B	A	B	A	B	A	B	A	B	A	B	A	B	A	B	A	B	A	B
D	A	B	A	B	A	B	A	B	A	B	A	B	A	B	A	B	A	B	A	B	A	B	A	B
E	A	B	A	B	A	B	A	B	A	B	A	B	A	B	A	B	A	B	A	B	A	B	A	B
F	A	B	A	B	A	B	A	B	A	B	A	B	A	B	A	B	A	B	A	B	A	B	A	B
G	A	B	A	B	A	B	A	B	A	B	A	B	A	B	A	B	A	B	A	B	A	B	A	B
H	A	B	A	B	A	B	A	B	A	B	A	B	A	B	A	B	A	B	A	B	A	B	A	B
I	A	B	A	B	A	B	A	B	A	B	A	B	A	B	A	B	A	B	A	B	A	B	A	B
J	A	B	A	B	A	B	A	B	A	B	A	B	A	B	A	B	A	B	A	B	A	B	A	B
K	A	B	A	B	A	B	A	B	A	B	A	B	A	B	A	B	A	B	A	B	A	B	A	B
L	A	B	A	B	A	B	A	B	A	B	A	B	A	B	A	B	A	B	A	B	A	B	A	B
M	A	B	A	B	A	B	A	B	A	B	A	B	A	B	A	B	A	B	A	B	A	B	A	B
N	A	B	A	B	A	B	A	B	A	B	A	B	A	B	A	B	A	B	A	B	A	B	A	B
O	A	B	A	B	A	B	A	B	A	B	A	B	A	B	A	B	A	B	A	B	A	B	A	B
P	A	B	A	B	A	B	A	B	A	B	A	B	A	B	A	B	A	B	A	B	A	B	A	B

To process a partial plate, you must select the sector you want to process:

- Keypad users see: Define the Plate Type and Plate Map or Partial Plate on page 50 for instructions.

Sectors to wash: 2

Checkmarks show the sectors to be processed. Numbers show potential sectors that are currently unselected and will not be washed. The 192-tube manifold processes the plate in two sectors.

A	B

Maintenance

Properly maintaining the 405 LS is the key to reliable performance.

Overview	117
Recommended Maintenance Schedule	119
Daily Maintenance	121
Overnight/Multi-Day Maintenance	121
AutoPrime	122
AutoPrime for Overnight-Weekend Maintenance	123
Turn on AutoPrime for the Washer	123
Removing Protein Residuals and Fungi Growth	124
AutoClean the Washer	125
Quick Clean (Keypad Only)	126
Create an AutoClean protocol	127
Periodic Maintenance	128
Clean the Bottles	128
Clean the Plate Carrier	129
Clean the Vacuum Filtration Carrier	129
Clean the exterior surfaces and mist shield	130
Clean the Buffer Bottle Filter	130
Remove and clean the washer manifold	131
Maintaining the Vacuum Filtration System	133
Clean the Vacuum Filtration Carrier	133
Maintain the Verify™ Technology Components	133
Clean the Verify™ Level Sensor	133
Replacement Procedure for Verify Test Plate	134
Volume coefficients - Slope and Offset	137
Decontamination	138
Tools and Supplies	138
Decontaminate Exterior Surfaces	139
Decontaminate Tubing and Manifold	140
Alternate Decontamination Procedure for Tubing and Manifold	141
Decontaminate the Vacuum Filtration System	142
Long Shutdown Procedure (Prepare for Storage or Shipment)	143

Storing the Instrument	144
Replace Components	144
Remove/Change Wash Manifold	145
Replace the Vacuum Pump Fuse	145
Vacuum Filtration Carrier: Replace the Gasket	146

Overview

A **Preventive Maintenance (PM)** regimen for the 405 LS includes rinsing and soaking the fluid path and cleaning and/or autoclaving the various components. The level of maintenance required to keep the instrument performing as expected is dependent on several factors, including the type of fluid dispensed, the frequency of use, and the work habits employed.

The Recommended Maintenance Schedule on page 119 summarizes BioTek's recommended maintenance tasks, and indicates approximately how often each task should be performed. Daily and periodic routines and minimal guidelines for frequency are listed. Beyond that, it is difficult for BioTek to recommend a fixed frequency for each task to be performed. The frequency of conducting these tasks must be based on the risk and performance factors of your assays.

Develop a maintenance schedule for your 405 LS based on the characteristics of the fluids used and the activity level. Here are some guidelines for each component:

Washer

- When using fluids prone to dry and harden quickly, the washer's dispense and aspirate tubes can clog quickly, and must be rinsed frequently and cleaned regularly. Run **AutoClean** ultrasonic cleaning regularly, when available. Otherwise, Remove and clean the washer manifold on page 131.
- If the washer will be idle for several hours or days at a time, soak the tubes to keep them in a "wetted" state. Enable **AutoPrime** if the washer is idle for more than 3 hours.
- Wash solutions affect the rinse frequency. If the solution does **not** contain surfactant, consider rinsing (or running **AutoPrime**) at least once an hour.

Recommended Maintenance Schedule

The schedule recommends preventive maintenance tasks, the frequency with which each task should be performed, and the predefined onboard Maintenance program that should be run (if applicable). [See Recommended Maintenance Schedule on page 119.](#)

■ It is important to note that the risk and performance factors associated with your assays may require that some or all of the procedures be performed more frequently than suggested in this schedule.

■ **Water:** Daily maintenance is the key to keeping the liquid handler performing to specifications. In the maintenance procedures provided in this manual, the requirement to use distilled (dH₂O) or deionized (DI) water can be met by

numerous water purification methods, including MilliQ™. A minimum water purity of 2mOhm is expected.

Recommended Maintenance Schedule

Keypad Users: The protocol names onboard the washer do not include the W- prefix and some protocols include the model name, e.g. 405HT or 405Select, when appropriate.

Tasks	Frequency				
	Daily	Overnight/ Multi-Day	Weekly	Periodic/ Monthly	Before storage/ shipment
Run W-DAY_RINSE	✓	✓			
Run AutoPrime	✓				
Run W-OVERNIGHT_LOOP		✓			
Run W-RINSE_AND_SOAK		✓			
Run Verify™ clog detection test	✓				
Run AutoClean				✓	✓
Components					
Remove protein residuals and fungi growth, (if necessary)	✓		✓	✓	
Check/empty waste bottles	✓				✓
Clean bottles				✓	✓
Clean plate carrier system			✓		✓
Clean washer manifold				✓	✓
Clean aspirate and dispense tubes				✓	✓
Clean exterior surfaces and mist shield			✓		
Clean fluid inlet filter				✓	✓
Clean vacuum filtration system				✓	✓
Clean the Verify™ level sensor				✓	✓
Decontaminate					
Decontaminate external surfaces				✓	✓
Run W-DECONTAMINATE				✓	✓
Decontaminate vacuum filtration system				✓	

Tasks	Frequency				
	Daily	Overnight/ Multi-Day	Weekly	Periodic/ Monthly	Before storage/ shipment
Prepare for Storage or Shipment					
Run W-LONG_SHUTDOWN					✓
Replace/Repair Components					
Replace the Verify Test Plate	As Needed				

Daily Maintenance

Daily maintenance involves flushing the washer with an appropriate reagent or deionized water throughout the day. Routine rinsing helps to prevent the aspirate and dispense tubes from clogging between runs. Flushing the devices with deionized water is recommended at the end of the day for most applications.

The recommended **rinsing frequency** depends on the solutions currently in use:

- When a solution containing surfactant is used throughout the day, perform the rinsing procedure when the device is idle for more than 3 hours.
- When the solution does **not** contain surfactant, consider rinsing at least once an hour.

Run this protocol and enable **AutoPrime** to satisfy the daily maintenance requirements:

- DAY_RINSE

Make sure the supply bottles contain sufficient rinse solution and that the waste bottles are empty before running the protocols.



Also see the additional maintenance procedures required when dispensing protein solutions: Removing Protein Residuals and Fungi Growth on page 124.

AutoPrime

AutoPrime automatically conditions the dispense tubes, priming them with the specified volume, after a user-specified amount of idle time. [See **AutoPrime** on next page.](#)

- Press the **STOP** button to interrupt the AutoPrime routine when it is underway.
- Any interaction with the instrument via the keypad or the LHC resets the interval clock.
- AutoPrime only runs when the main menu, quick menu, or run completion message is displayed on the keypad.

Overnight/Multi-Day Maintenance

Overnight/multi-day maintenance involves flushing all solutions out of the instrument, and then periodically rinsing and soaking the tubes to keep them moist. Here are three recommendations for accomplishing the task. Employ the method that best suits your work flow:

Overnight Loop

To keep the wash manifolds in a wetted condition, you can run these predefined protocols to soak the tubes for several hours at a time:

- **OVERNIGHT_LOOP**: requires the washer to remain turned on.
- **RINSE_AND_SOAK**: alternatively, run this protocol and turn off the instrument after the soak begins. The tubes will soak in the priming trough until the instrument is turned on again.

AutoPrime

LHC: Tools>Instrument Utilities> AutoPrime

Keypad: Select UTIL at the main menu, then AUTPRM

Recommended for optimum performance, AutoPrime keeps the tubing wet in between runs and can be an essential part of your daily maintenance routine.

About AutoPrime

AutoPrime automatically primes the tubing whenever the instrument is idle for a specified time. Keeping the tubes wet prevents clogging and mitigates fluid evaporation at the tips. AutoPrime's submerge feature lets you soak the tubes for extended periods, which is an effective maintenance option.

Specify the Interval and AutoPrime Parameters

AutoPrime runs when the instrument has been idle for a specified interval.

To set the **AutoPrime Interval**:

LHC:	Keypad:
<ol style="list-style-type: none"> 1. Select Tools>Instrument Utilities> AutoPrime tab. 2. Specify the idle-time interval that will trigger an AutoPrime; up to 24 hours. 3. Enable and define the parameters. Remember to set a Submerge Duration to employ this option. 	<ol style="list-style-type: none"> 1. Select UTILS at the main menu and select AUTPRM. 2. Specify the idle-time interval that will trigger an AutoPrime; up to 24 hours in minutes and press Enter. 3. Set the Submerge Duration, if desired. 4. "Enable AutoPrime."

LHC:	Keypad:
4. Click Send to transfer the settings to the instrument.	5. Define the AutoPrime parameters: rate, volume, and buffer valve, if applicable. Press Enter at each screen to advance to the next.

AutoPrime for Overnight-Weekend Maintenance

AutoPrime can be used to keep the manifold tubes wetted during idle periods throughout the day and then modified to soak the tubing for longer periods overnight and on the weekends. [See AutoPrime on previous page](#) for setup instructions.

AutoPrime Parameters	Washer
AutoPrime Interval	15 minutes
Device	Washer
AutoPrime	Yes/Enabled
Volume	90 mL
Rate	09
Buffer	Any
Submerge Duration	120 minutes/2 hours

Turn on AutoPrime for the Washer

- Learn about [AutoPrime](#), if you haven't already done so.

■ **Keypad users:** Select **UTIL** at the main menu, then **AUTPRM** and specify parameters.

1. Select **Tools>Instrument Utilities>AutoPrime**.
2. Fill the **Enabled** checkbox.
3. Set the **AutoPrime Interval**: enter the downtime interval that will trigger an AutoPrime.
4. Select the **Buffer** to use if you have Buffer Switching installed.
5. Set the **Volume** and **Rate**. The default values are 40 mL at flow rate 9.

6. You can **Submerge** the manifold tubes in the fluid **after** the **prime**, if desired. Set **Duration** in **Hours** and **Minutes**.

After the dispense tubes have been primed, the manifold moves down into the priming trough that is filled with the dispensed solution. The vacuum pump is turned off and the tubes are allowed to soak. After the specified duration, the vacuum pump is turned on and the trough is aspirated.

It takes approximately 93 mL of fluid to fill the priming trough. Be sure to specify a volume of fluid that will cover the tubes.

7. Click **Send** to transfer the settings to the instrument.

Keep in mind:

- AutoPrime can be stopped when it is underway: press STOP on the keypad.
- Any interaction with the instrument via the keypad or the LHC resets the interval clock.
- AutoPrime only runs when the main menu, quick menu, or run completion message is displayed.

Removing Protein Residuals and Fungi Growth

Important! Solutions containing proteins, such as bovine serum albumin (BSA), will compromise the 405 LS's performance over time unless a strict maintenance regime is adhered to. Do not use isopropyl alcohol to flush out BSA.

When using protein solutions or similar fluids, BioTek recommends performing the following additional Maintenance procedures to thoroughly flush out protein particles and other contaminants from the fluid path.

Daily Practice with buffer or deionized water:

If the 405 LS will be idle between plates for longer than 45 minutes, flush the proteins:

1. Fill a supply bottle with deionized water. Connect the bottle to the washer. (Buffer valve "A" for Buffer Switching models)
2. Run the DAY_RINSE protocol.
3. Enable AutoPrime for 60-minute intervals.

At the end of the day:

1. Fill a supply bottle with deionized water. Connect the bottle to the washer (Buffer valve "A" for Buffer Switching models).

2. Run the DAY_RINSE protocol three times.
3. Perform your regular Overnight/Multi-Day Maintenance routine.

Weekly or As Needed use NaOH and HCl to remove proteins:

1. Flush the system with 0.1-0.5 N* NaOH (sodium hydroxide), followed by neutralization with an equivalent normality (0.1-0.5 N) of HCl (hydrochloride).
2. Rinse well with deionized water to remove the HCl.
3. Run the applicable DAY_RINSE protocol three times with deionized water if you plan to use the device immediately.

* N = Normal solution, which contains 1 'gram equivalent weight' (gEW) of solute per liter of solution. The gram equivalent weight is equal to the molecular weight expressed as grams divided by the 'valency' of the solute.

Alternatively use an Enzyme-Active Detergent:

1. Mix an enzyme-active detergent according to the manufacturer's directions to fill a four-liter supply bottle. Connect the bottle to the washer's Buffer valve A. Connect a bottle of deionized or distilled water to Buffer valve B to rinse the tubing.
2. Run the **DECONTAMINATE** protocol, as appropriate.
3. **LHC users:** Respond to the **Delay** message, "Connect a bottle of water...", leave the detergent bottle connected and when ready, press **Continue**.
4. When the protocol is completed, connect a bottle containing four liters of deionized water and run DAY_RINSE three times to flush the system.

AutoClean the Washer

 Learn About AutoClean on next page

Some models of the 405 LS feature BioTek's Ultrasonic Advantage™ for easy and thorough cleaning of the wash manifold. Instruments with AutoClean capability are easily identified by the stainless steel priming reservoir built into the instrument's base, under the wash manifold.

 **Warning!** Ultrasonic energy is present in the cleaning reservoir when the AutoClean program is running. Do not put your fingers in the bath! Ultrasonic energy can harm human tissue.

■ **Important!** Ensure there is adequate room in the waste bottle and sufficient volume in the supply bottle **before** running AutoClean!

 **Tip:** Detergent such as Terg-A-Zyme® added to deionized water in the supply bottle helps to break down the water's surface tension and enhances the cleaning process. Terg-A-Zyme also contains protease enzyme for assimilating proteinaceous residue such as bovine serum albumin (BSA).

About AutoClean

BioTek's **Ultrasonic Advantage™** is a built-in ultrasonic cleaner that provides enhanced maintenance capabilities by using ultrasonic pulses in a water bath to clean the manifold tubes. Ultrasonic energy causes cavitation forces within the water bath, which in turn cause tiny vapor bubbles to be created. The formation and subsequent collapse of these bubbles is the mechanism that cleans the manifold tubes submerged in the bath.

The cleaner consists of a stainless steel reservoir with an ultrasonic transducer bonded to the bottom of the reservoir. The reservoir is mounted under the washer manifold and also functions as the priming trough.

■ Do not try to remove the ultrasonic cleaner! Only BioTek authorized service personnel should remove the ultrasonic cleaner for maintenance or repair.

While the program is running, the ultrasonic cleaner will pulse on and off approximately every ten seconds, and you will hear a periodic hissing sound that indicates the ultrasonic energy is present.

■ Not all 405 LS models are equipped with this feature.

Quick Clean (Keypad Only)

Select Quick>Sonic

Take advantage of the 405 LS's "Ultrasonic Advantage" to make sure the manifold tubes are clean and clog-free.

1. Connect a bottle with detergent or an appropriate solution for your assay. The 405 LS primes the system with 300 mL/305 mL for CW models and fills the trough with 93 mL for the sonicator. Buffer Switching models: specify the **CLNBUF** (Clean Buffer) valve it is connected to; non-Buffer Switching models will be prompted to change buffer bottles.

2. Fill the "Rinse Buffer" bottle with at least 305 mL of deionized or distilled water or with a wash buffer to leave the instrument primed and ready for use. Buffer Switching models: specify the **RINBUF** (Rinse Buffer) valve.
3. Set the desired duration in minutes, up to 4 hours, to soak the tubes and run the sonicator: use the arrow or **Options** key.
4. When you're ready, press **Start**.

Warning! Ultrasonic energy is present in the cleaning reservoir when the AutoClean program is running. Do not put your fingers in the bath! Ultrasonic energy can harm human tissue.

Important! Ensure there is adequate room in the waste bottle and sufficient volume in the supply bottle **before** running AutoClean!

Create an AutoClean protocol

Create an **AutoClean** protocol for regular use. Make sure it begins by priming the tubing with the cleaning fluid. Approximately **93 mL** of fluid fills the reservoir during each run.

General Recommendation: Run **AutoClean** for 1 hour. Follow with a full prime using deionized water to remove the detergent from the system and/or with a wash buffer to leave the instrument primed and ready for use.

LHC	Keypad
W-AutoClean	DEFINE>CREATE>NAME>PLATE>ADD> → >ACLEAN

Define the cleaning protocol:

1. First, add a **Prime** step to fully prime the tubing with the cleaning fluid (or water).
2. Add an **AutoClean** step to the protocol.
3. **Buffer Valve:** select the supply bottle containing the desired cleaning fluid if Buffer Switching is installed.
4. **Duration:** enter the duration, up to 4 hours. Input the time in minutes when using the keypad; hours and minutes when using LHC.
5. Click **OK** to add a cleaning step to the protocol.

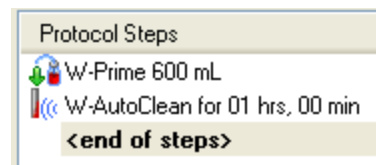

Periodic Maintenance

Periodic maintenance involves cleaning the components on a regular basis to keep the instrument running efficiently and in compliance with performance specifications. The recommended **frequency for cleaning components** is *at least monthly*. The risk and performance factors associated with your assays may require that some or all of the procedures be performed more frequently.

 **Warning! Internal Voltage.** Turn off and unplug the instrument for all cleaning operations.

■ **Important:** Do not apply lubricants to channel-end seals, bottle cover seals, any tubing connection, or any surface that is a part of the fluid path. The use of any lubricant on the fluid handling components will interfere with aspirate and dispense performance, and may cause irreparable damage to these components.

■ **Water:** Daily maintenance is the key to keeping the liquid handler performing to specifications. In the maintenance procedures provided in this manual, the requirement to use distilled (dH₂O) or deionized (DI) water can be met by numerous water purification methods, including MilliQ™. A minimum water purity of 2mOhm is expected.

Important!

- Do not immerse the instrument, spray it with liquid, or use a “wet” cloth on it.
- Do not allow the cleaning solution to run into the interior of the instrument. (If this happens, contact the BioTek TAC.)
- Do not expose any part of the instrument to the recommended diluted sodium hypochlorite solution (bleach) for more than 20 minutes. Prolonged contact may damage the instrument surfaces.
- Be certain to rinse and thoroughly wipe all surfaces.
- Do not soak the keypad. Instead, moisten a clean cloth with deionized or distilled water and wipe the keypad. Dry it immediately with a clean, dry cloth.

Perform these preventive maintenance tasks regularly:

- Clean the Bottles below
- Clean the Plate Carrier on the facing page

Clean the Bottles

- Clean and rinse the supply bottles with deionized water before the first use, before each refill, and, periodically, as necessary, to prevent bacteria growth.

- Empty the waste bottle often (at least daily), and firmly seat the waste bottle stopper.
- Rinse the covers every time the wash or rinse bottles are filled.
- Accumulated algae, fungi, or mold may require decontamination.

■ To ensure that fluid does not back up into the vacuum pump during operation, always operate the instrument with the **waste sensor cable** installed and the **waste detection sensor** enabled (the sensor is enabled by default).

 If fluid collects in the **overflow bottle**, thoroughly rinse the level-switch assembly and bottle.

- Check the hex nuts securing the quick-disconnects to the bottle cap to ensure they are not loose or corroded.

Clean the Plate Carrier

If liquid has overflowed onto the plate carrier, transport rail, or glide strips, some buildup may occur and prevent the microplate from seating correctly on the carrier. This can interfere with plate transport. Weekly cleaning is recommended.

1. Turn the instrument off.
2. Lift the carrier up and off the transport rail.
3. Clean the carrier, rails, and glide strips, using mild detergent and hot water, 70% isopropyl alcohol, or ethanol. Clean the priming trough, too.
4. If detergent was used, wipe the components with a cloth moistened with water. Use a clean, dry cloth to dry the components.
5. Reinstall the carrier:
 - If necessary, release the spring-loaded microplate clamp in the back left corner of the carrier to level the carrier on the base.

Clean the Vacuum Filtration Carrier

Use a damp cloth to wipe up any spills, especially if the fluid is prone to dry and harden quickly. If necessary, flush it out with warm water by holding it under a running faucet for a few seconds.

Clean the exterior surfaces and mist shield

1. Turn off the instrument and disconnect the power cable.
2. Moisten a lint-free disposable towel with water, or with water and mild detergent. **Do not soak the cloth.**
3. Remove the mist shield if it is attached. Wipe the inside and outside surfaces of the mist shield with the towel. Wipe the top surface of the instrument base and all exposed surfaces of the instrument.
4. Verify™ Technology ("Q" models): Release the catch (on left side) and lift the level-sense unit (above the wash manifold) to gain access to all sides of the wand. Gently wipe off the wand.
5. If detergent was used, wipe all surfaces with a cloth moistened with water.
6. Use a clean, dry cloth to dry all wet surfaces.

Clean the Buffer Bottle Filter

Periodically clean the buffer bottle filter (PN 01310):

- Perform this task when the buffer bottle is empty or over a sink to catch spillage.

1. Open the buffer bottle and lift the cap and its tubing up and out of the bottle.
2. Remove the fluid filter at the bottom of the tubing.
3. Wash the filter with hot water and a soft-bristled brush, if necessary.
4. Rinse the filter and reinstall it.





Remove and clean the washer manifold

■ **DO NOT AUTOCLAVE** the manifold!

1. Run the system "dry" to remove any fluid: remove the supply tubing from the fluid or connect an empty supply bottle to the 405 LS and run a prime protocol, e.g. **RINSE_&_SOAK**, until the tubing is empty.
2. Turn off the instrument, disconnect the power cable and remove the mist shield.

■ Dual manifolds: Hold the two manifolds together as a single unit when removing and reinstalling.

 Have a towel handy to mop up drips from the manifold.

- Carefully remove the manifold(s) and end plates.
- Using a soft-bristled brush, thoroughly clean the outside surfaces.
- Clean inside each tube with the appropriate stylus (aspirate/dispense). Flush hot water through the cross channels to wash away debris.

 Soak the manifold in hot soapy water before using the stylus if the manifold is encrusted with residue.

 Avoid pressing the stylus against the sides of the tubes during cleaning. This can cause the tubes to bend, adversely affecting dispense precision.

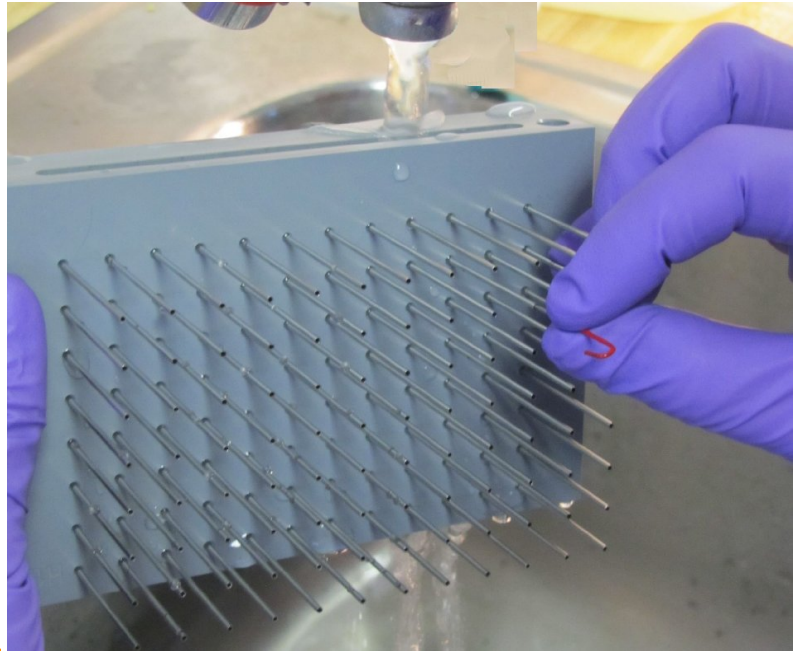

- Rinse the manifold with deionized or distilled water. Check to see if water comes out of all dispense and aspirate tubes. If not, soak the manifold in hot, soapy water and repeat.
- When satisfied, reassemble the manifold and end plates.
- Install the mist shield.
- Reconnect the power cable and turn on the instrument.
- Prime the system with deionized water by running **DAY_RINSE** or a similar Maintenance or Prime protocol. Watch for leaks. If fluid leaks out of the back of the instrument, firmly seat the tubing. If fluid leaks from the manifold, try disassembling and carefully reassembling.
- Verify aspirate/dispense performance visually or by performing the [qualification tests](#).

 **Ultrasonic Advantage™**: For optimal results after using the stylus, fully prime the system and run [AutoClean](#) for 30 minutes.

Maintaining the Vacuum Filtration System

Perform the following tasks as part of your regular maintenance when you are using the vacuum filtration system:

Clean the Vacuum Filtration Carrier

Use a damp cloth to wipe up any spills, especially if the fluid is prone to dry and harden quickly. If necessary, flush it out with warm water by holding it under a running faucet for a few seconds.

- Decontaminate the Vacuum Filtration System on page 142
- Vacuum Filtration Carrier: Replace the Gasket on page 146 (as needed)

Maintain the Verify™ Technology Components

To keep 405 LS's with Verify™ Technology, "Q" models, performing as expected:

- Keep the Verify Test Plate clean. Remove any salt deposits or other contaminants.
- Regularly inspect the plate for damage.
- Inspect the plate at least annually and replace it when necessary: Replacement Procedure for Verify Test Plate on next page.
- Clean the level sensor at least annually or as needed: Clean the Verify™ Level Sensor below.

Clean the Verify™ Level Sensor

Annually or as needed, give the level sensor a deep cleaning.

Clean the **Collimator**:

The collimator is the narrow plastic sleeve or arm of the level sensor that focuses detection at the wells.



1. Make sure the wash manifold is in its home position. (Run Self-check, if needed.)
2. Turn off and unplug the washer.
3. Release the latch that holds the Verify unit in place above the wash manifold.

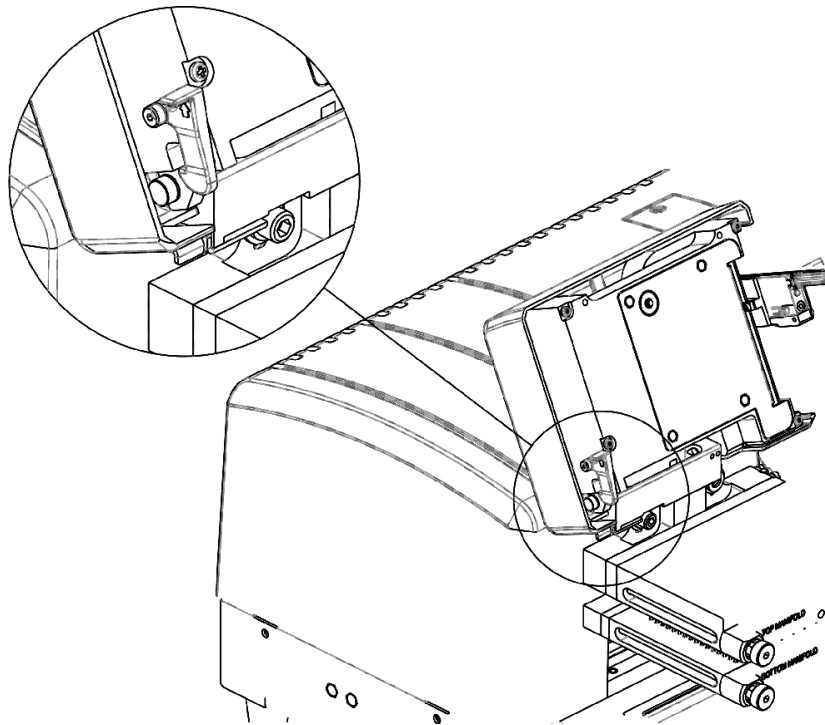

3. Gently pull the collimator off the level sensor.
4. Wipe off the collimator to remove any contaminants. If necessary, soak the collimator in hot, soapy water to remove material that has hardened or resists cleaning.
5. Dry the collimator with a soft, lint-free towel or allow to air dry.
6. When the collimator is completely dry, reinstall it. Snap the collimator back in place on the level sensor.

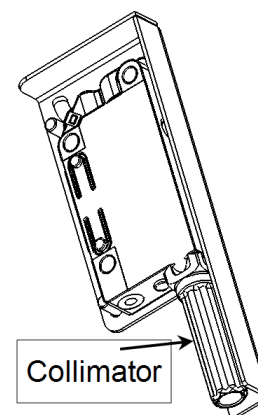

Replacement Procedure for Verify Test Plate

Before it leaves the factory, BioTek calibrates the 405 LS to use a specific Verify Test Plate. That test plate is labeled with 405 LS's serial number. When a replacement plate is needed, follow these instructions to recalibrate the 405 LS for the new plate.

Required Materials:

- Precision digital balance with a capacity of 400 g and readability of 0.01 g resolution
- 200 mL **Solution #3**: Dispense Precision solution. This volume is sufficient for two test runs. **See Washer Qualification Test Materials on page 155.**
- The Excel spreadsheet provided on the operator's manual CD to perform the required calculations: in the Verify Technology Spreadsheets folder, open **VerifyPlateReplacement.xls**.

Prerequisites:

- Make sure the replacement Verify Test Plate is clean and dry to begin this procedure.
- Mix the dye solution, fill a buffer bottle attached to the washer, and fully prime the system.

1. Perform Test Plate Alignment**LHC**

1. Select **Tools>Instrument Utilities>Verify Manifold>Configure Utilities**.
2. Put the test plate on the carrier and click **Test Plate Alignment**.

This process updates configuration data needed to successfully run the Verify routine.

2. Determine the Slope and Offset Volume Coefficients

- This step is not mandatory but strongly recommended to ensure the most reliable performance.

1. Put the Verify Test Plate on the balance and tare the balance.
2. Run the special procedure:

Touch screen	LHC
<ol style="list-style-type: none"> 1. Select Instrument>Other>Verify Technology. 2. Select Plate Replacement (select this button in the Sensor Calibration box) and press Start. 	<ol style="list-style-type: none"> 1. Select Tools>Instrument Utilities>Verify Manifold>Configure Utilities. 2. Click the Sensor Calibration link.

The 405 LS will perform the first part of the Verify process.

3. At the first pausing message, weigh the plate and record the **Aspirate Weight** (W_A) value.

4. Put the Verify Test Plate back on the carrier and click **OK** to continue.
5. At the second pause, weigh the plate again and record the **Dispense Weight** (W_D) value.
6. Put the test plate back on the carrier and click OK to continue.

LHC users: A time and date stamped .txt file is created when the process is completed.

Important: Touch screen users: Enter the weights onboard the washer when prompted. The washer will perform the calculation described below and automatically update the Slope and Offset. Skip the next two steps, but run the Verify routine as advised in Step 9.

Format and evaluate test results:

7. **LHC users only:** In the **Calibration Data** folder, open the report. Copy and paste **all** the data from the .txt file into the spreadsheet provided:
 - Select Ctrl+A and Ctrl+C
 - Select the **From405** tab and paste (Ctrl+V) all the data into the worksheet beginning at cell **A1**.

The slope and offset are calculated using these formulas:

Slope calculation:
$$Slope = \frac{(W_D - W_A)}{9600 \times (D_D - D_A)}$$

Offset calculation:
$$Offset = \frac{W_D}{0.096} - (Slope \times D_D)$$

- D_D is the **Dispense Scan Mean** value
- D_A is the **Aspirate Scan Mean** value reported in the date and time stamped .txt file.

8. **LHC users only:** Review the current **Slope** and **Offset** values and change them to match your calculated results, if they differ.

Touch screen	LHC
To review the values that were updated by this procedure: <ol style="list-style-type: none"> 1. Select Instrument>Other>Verify Technology and select Advanced. 2. See the Volume Coefficients. 	<ol style="list-style-type: none"> 1. Select Tools>Instrument Utilities>Verify Manifold>Configure Utilities. 2. Click the Advanced settings link.

9. Run the **Verify Manifold** routine and confirm passing results.

Important: Write the 405 LS's serial number on the Verify Test Plate label.

Volume coefficients - Slope and Offset

Slope:	0.535
Offset:	-227.9

BioTek's Verify™ Technology level sensor has been calibrated at the factory to work with a specific Verify Test Plate. These volume coefficients have been gravimetrically determined and set for your washer-test plate combination.

Important: Do not change these values unless specifically instructed to do so by BioTek, as when replacing the test plate, for example.

Note: default values are Slope = 0.6 and Offset = -200.0.

Decontamination

Any laboratory instrument that has been used for research or clinical analysis is considered a biohazard and requires decontamination prior to handling.

Decontamination minimizes the risk to all who come into contact with the instrument during shipping, handling, and servicing. Decontamination is required by the U.S. Department of Transportation regulations. Persons performing the decontamination process must be familiar with the basic setup and operation of the instrument.

The recommended **frequency for decontamination** is at least monthly, and before shipment of the instrument to BioTek for calibration or repair.

■ **Important!** BioTek Instruments, Inc. recommends the use of the following decontamination solutions and methods based on our knowledge of the instrument and recommendations of the Centers for Disease Control and Prevention (CDC). Neither BioTek nor the CDC assumes any liability for the adequacy of these solutions and methods. Each laboratory must ensure that decontamination procedures are adequate for the biohazards they handle.

 **Warning! Internal Voltage.** Turn off and unplug the instrument for all decontamination operations.

■ **Do not** immerse the instrument, spray it with liquid, or use a “wet” cloth. Do not allow the cleaning solution to run into the interior of the instrument. If this happens, contact the BioTek TAC. **Do not soak the keypad.**

■ **Wear prophylactic gloves** when handling contaminated instruments. Gloved hands should be considered contaminated at all times; keep gloved hands away from eyes, mouth, nose, and ears. Eating and drinking while decontaminating instruments is not advised.

■ Mucous membranes are considered prime entry routes for infectious agents. Wear eye protection and a surgical mask when there is a possibility of aerosol contamination. Intact skin is generally considered an effective barrier against infectious organisms; however, small abrasions and cuts may not always be visible. Wear protective gloves when performing the decontamination procedure.

Tools and Supplies

0.5% sodium hypochlorite (NaClO, or bleach)

70% isopropyl alcohol (as a bleach alternative)
Deionized or distilled water
Priming plate
Safety glasses
Surgical mask
Protective gloves
Lab coat
Biohazard trash bags
Clean cotton cloths

Step-by-Step Decontamination Instructions:

- Decontaminate Exterior Surfaces below
- Decontaminate Tubing and Manifold on next page
- Alternate Decontamination Procedure for Tubing and Manifold on page 141

Decontaminate Exterior Surfaces

 **Caution!** Be sure to check the percentage NaClO of the bleach you are using; this information is printed on the side of the bottle. Commercial bleach is typically 10% NaClO; in this case, prepare a 1:20 dilution. Household bleach is typically 5% NaClO; in this case, prepare a 1:10 dilution.

 The bleach solution is caustic; wear gloves and eye protection when handling.

1. Turn off the instrument and disconnect the power cord. Empty the waste bottle.
2. Prepare an aqueous solution of 0.5% sodium hypochlorite (NaClO, or bleach). As an alternative, 70% isopropyl alcohol (or 70% ethanol) may be used if the effects of bleach are a concern.

■ **Isopropyl alcohol** is not recommended for removing **proteins** (such as bovine serum albumin).

3. Moisten a cloth with the bleach solution or alcohol. **Do not soak the cloth.**
 - Wipe the keypad (do not soak). Wipe again with a clean cloth moistened with deionized or distilled water. Dry immediately with a clean, dry cloth.
 - Remove the mist shield if it is attached. Wipe the inside and outside surfaces of the mist shield.

- Wipe the plate carrier, top surface of the instrument's base, supply bottles and tubing, and all exposed surfaces of the instrument.
4. Wait 20 minutes. Moisten a cloth with DI or distilled water.
 - Wipe the inside and outside surfaces of the mist shield.
 - Wipe the plate carrier, top surface of the instrument's base, supply bottles, tubing, bottle covers and all exposed surfaces of the instrument that have been cleaned with the bleach solution or alcohol.
 5. Use a clean, dry cloth to dry all wet surfaces.
 6. Reassemble the instrument as necessary.
 7. Discard the used gloves and cloths using a biohazard trash bag and an approved biohazard container.

Decontaminate Tubing and Manifold

Predefined protocols to flush and soak the supply tubing and manifolds with disinfectant, then flush the system with rinse fluid are installed onboard the instrument and on the host computer during installation of the LHC:

- **DECONTAMINATE** for the washer

When storing or shipping the instrument, the **LONG_SHUTDOWN** procedure (on page 143) primes and soaks the instrument, and ends by pushing air through the system. The parameters can be edited for optimum cleaning. For example, consider using ethanol instead of air to complete the decontamination process.

- Two supply bottles are required for this procedure: one for disinfectant, and one for rinse. Except Buffer Switching models require four bottles altogether, two of each solution.

1. Empty the waste bottle.
2. Prepare an aqueous solution of 0.5% sodium hypochlorite (NaClO, or bleach).
3. Fill one or two supply bottles with at least 300 mL of bleach solution (disinfectant).
4. Fill another supply bottle or two with at least 500 mL of deionized water (rinse).

When using **Buffer Switching**:

- Buffer valve C & D: Disinfectant
- Buffer valve A & B: Rinse solution (they will be reversed in the next round)

Without Buffer Switching, connect the bottle containing disinfectant to the **Fluid In** port.

5. Reconnect the power cord and turn on the instrument.
6. Run the decontamination protocols.

Preparing to run **DECON** or **W-DECONTAMINATE**:

With Buffer Switching	<p>Connect the supply bottles this way:</p> <ul style="list-style-type: none"> • Buffer bottles C and D: Disinfectant • Buffer bottles A and B: Rinse solution <p>After disinfecting channels C and D, you will reverse this assignment to disinfect channels A and B.</p> <p>Keypad: Run DECON_STEP1, DECON_STEP2, and DECON_STEP3.</p> <p>LHC: At the prompt/delay, change bottles.</p>
Without Buffer Switching	<p>Connect the disinfectant bottle to the Fluid In port.</p> <p>Keypad: Run DECON_STEP1 followed by DECON_STEP2.</p> <p>LHC: At the prompt/delay, change bottles.</p>

Alternate Decontamination Procedure for Tubing and Manifold

If you are unable to run the decontamination protocols due to a system failure, perform the following alternate decontamination procedure to disinfect the internal tubing and manifolds.

 **Caution!** Be sure to check the percentage NaClO of the bleach you are using; this information is printed on the side of the bottle. Commercial bleach is typically 10% NaClO; in this case, prepare a 1:20 dilution. Household bleach is typically 5% NaClO; in this case, prepare a 1:10 dilution.

1. Turn off the instrument and disconnect the power cord.
2. Remove the mist shield.
3. Remove the wash manifold(s) and end plate(s).

■ For dual manifold models, hold the two manifolds (and end plates) together as a single unit when removing and replacing them.

4. Prepare an aqueous solution of 0.5% sodium hypochlorite (bleach). As an alternative, 70% isopropyl alcohol (or ethanol) may be used if the effects of bleach are a concern.

■ **Isopropyl alcohol** is not recommended for removing **proteins** (such as bovine serum albumin).

5. Soak the tubing and manifold in the bleach or alcohol solution.
6. Wait 20 minutes. Rinse the tubing and manifold with DI or distilled water.
7. Use a clean, dry cloth to dry all wet surfaces of the tubes and manifold.
8. Reassemble the washer manifold, making sure that the o-rings/gaskets are in place prior to reassembly.
9. Re-attach the mist shield.
10. Prime the system by running **W-DAY_RINSE** or a similar Maintenance or Prime protocol. Watch for leaks. If fluid leaks out of the back of the instrument, firmly seat the tubing. If fluid leaks from the manifold, try disassembling and carefully reassembling.
11. Discard the used gloves and cloths using a biohazard trash bag and an approved biohazard container.
12. Verify performance visually or by performing qualification tests.

Decontaminate the Vacuum Filtration System

First, disinfect the tubing, then, remove and soak the carrier:

Decontaminate the tubing:

Run the predefined protocol **QC_96/384_VAC30/10_TEST** (depending on your instrument model) with disinfectant as the fluid supply to clean the tubing and hardware used to perform filter plate assays.

1. Connect a supply bottle filled with 200 mL of bleach solution/disinfectant.
2. Insert the black vent plug into the vent port on the front of the carrier.
3. First prime the tubing.
4. Run **QC_96/384_VAC30/10_TEST**.
5. When the run is completed, replace the decontamination fluid supply with deionized or distilled water and rerun it once or twice.

Decontaminate the vacuum filtration carrier:

1. Turn off and unplug the instrument.
2. Disconnect the tubing from the vacuum carrier.
3. Remove the carrier and soak it in the Decontamination (bleach) solution for 20 minutes.

4. Rinse the carrier thoroughly to remove all bleach.
5. Use a clean, dry cloth to dry all wet surfaces.

Inspect the plate seal gasket and replace it if defects are observed replace the gasket: Vacuum Filtration Carrier: Replace the Gasket on page 146.

Long Shutdown Procedure (Prepare for Storage or Shipment)

Before the 405 LS is shipped or stored, the entire system should be rinsed and soaked with disinfectant and then purged of all fluid. Perform these steps when leaving the instrument unused for a long period of time.

Predefined protocols are installed onboard the instrument and on the host computer during installation of the LHC:

LHC	Keypad
W-DECONTAMINATE	DECON_STEP1, STEP2, STEP3
W-LONG_SHUTDOWN	PURGE_SYSTEM_WITH_AIR

- Two supply bottles are required for this procedure: one for disinfectant, and one for rinse. Except Buffer Switching models require four bottles altogether, two of each solution.

1. Empty the waste bottle.
2. Prepare an aqueous solution of 0.5% sodium hypochlorite (NaClO, or bleach).
3. Fill one or two supply bottles with at least 300 mL of bleach solution (disinfectant).
4. Fill another supply bottle or two with at least 500 mL of deionized water (rinse).

When using Buffer Switching:

- Buffer valve C & D: Disinfectant
- Buffer valve A & B: Rinse solution (they will be reversed in the next round)

Without Buffer Switching, connect the bottle containing disinfectant to the **Fluid In** port.

5. Reconnect the power cord and turn on the instrument.
6. Run the decontamination protocols.

Preparing to run **DECON** or **W-DECONTAMINATE**:

With Buffer Switching	<p>Connect the supply bottles this way:</p> <ul style="list-style-type: none"> • Buffer bottles C and D: Disinfectant • Buffer bottles A and B: Rinse solution <p>After disinfecting channels C and D, you will reverse this assignment to disinfect channels A and B.</p> <p>Keypad: Run DECON_STEP1, DECON_STEP2, and DECON_STEP3.</p> <p>LHC: At the prompt/delay, change bottles.</p>
Without Buffer Switching	<p>Connect the disinfectant bottle to the Fluid In port.</p> <p>Keypad: Run DECON_STEP1 followed by DECON_STEP2.</p> <p>LHC: At the prompt/delay, change bottles.</p>

7. Finally, disconnect the supply tubing from the washer to completely purge the system of all fluid by priming the tubing with air. **Keypad:** Run **PURGE_SYSTEM_WITH_AIR**. **LHC:** Follow the prompts.

Storing the Instrument

After performing the Long Shutdown (Prepare for Storage or Shipment) protocols:

- Turn off the instrument and disconnect the power cord.
- Store it on a flat surface that is relatively free of vibration, in a dust-free and particle-free environment.
- Protect the instrument from temperature extremes that can cause condensation within the unit and from corrosive fumes and vapors.
- Store the instrument under the following environmental conditions:

Temperature:	20° to 50°C (-4° to 122°F)
Relative humidity:	10% to 85% (non-condensing)

- Important: Allow the instrument to reach room temperature before use after storage.

Replace Components

Some components of the 405 LS must be replaced periodically to maintain specified performance levels.

- Replace the Vacuum Pump Fuse on the facing page
- Clean the Fluid Inlet Filter on page 130
- Vacuum Filtration Carrier: Replace the Gasket on page 146

Remove/Change Wash Manifold

To clean or replace the wash manifold:

1. Run the system "dry" to remove any fluid: connect an empty supply bottle and run a prime protocol until the tubing is empty.
2. Turn off the instrument, disconnect the power cable, and remove the mist shield.
3. Release the thumbscrews that secure the manifold(s) in place.

■ Dual manifolds: Hold the two manifolds together as a single unit when removing and reinstalling.

4. Carefully slide the manifold(s) and end plates off their rails.

■ **DO NOT AUTOCLAVE** the manifold!

Reverse these steps to reinstall the manifold. Be sure to correctly position the manifold(s) on the rails; they only fit one way: the side with the recessed channel openings faces the washer. Make sure there are no gaps between the manifold and the washer.

Change the Instrument Settings

When you change the type of manifold, e.g. from a 96-tube to a 192-tube manifold, you must tell the instrument which manifold is installed:

LHC	Keypad
1. Select Tools>Instrument Utilities>Washer	1. Press Setup Menu (button in center of keypad).
2. Update the Manifold Selection .	2. Select → and then MANIF .
3. Click Send .	3. Select the currently installed wash manifold by pressing its Soft-key: Single or Dual 96-tube or 192-tube manifold.

Replace the Vacuum Pump Fuse

Spare fuses (PN 46055) are shipped with the instrument in case the pump blows a fuse.

Tools: Screwdriver

To change the fuse:

1. Locate the **Accessory Fuse** port on the rear panel below the **Accessory Outlet** for the vacuum pump.
2. Use a screwdriver to open the port and release the fuse. It has a spring action.
3. Replace the fuse and reinstall.

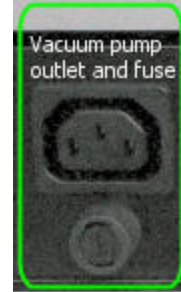

Vacuum Filtration Carrier: Replace the Gasket

If you observe damage to the vacuum filtration carrier's gasket, you must order a replacement part from BioTek, and follow these instructions to replace it.

Tools: Philips head screwdriver

1. Remove the carrier from the instrument and put on a level work surface.
2. With a Philips screwdriver, remove the six screws around the perimeter of the top of the carrier.
3. Lift off and set aside the top plate, and remove the gasket.
 - If the grate (located under the gasket) needs to be cleaned, rinse it under tap water. Allow the grate to dry before placing it and the gasket in the carrier.
4. Place the new gasket in the carrier, correctly positioning the notch with the corresponding indentation on the carrier's right side.

Note: The gasket fits only one way on the carrier. When replacing it, align the notch in the gasket with the small "bump" on the carrier.

5. Restore the top plate and its six screws. Do not overtighten.
6. Verify vacuum filtration performance by performing the Qualification procedure: Vacuum Filtration Evacuation Efficiency Test on page 165.

Qualification

This chapter provides instructions for periodically testing the instrument to verify that it meets performance specifications.

Qualification Overview	148
Qualification Schedule	149
System Self-Test, Verify Information	149
Sensor Test: Fluid, Waste, Plate Detection	150
Ultrasonic Cleaner Test	151
Liquid Testing the 405™ Microplate Washer LS	152
Washer Liquid Tests	154
Vacuum Filtration Evacuation Efficiency Test	165
Qualify the Verify™ Technology Sensor	167

Qualification Overview

Instrument verification for the 405 LS involves three activities: qualification of installation and setup, qualification of routine capability, and qualification of long-term stability. These activities are called Installation Qualification (**IQ**), Operational Qualification (**OQ**), and Performance Qualification (**PQ**), respectively.

Review the Qualification Schedule on the facing page.

Verification testing includes:

- The **System Self Test** verifies system components, such as the vacuum, manifold, and carrier positioning.

Washer

- **Evacuation Efficiency:** This test measures the residual volume per well after aspiration. The lower the residuals per well, the better the evacuation efficiency of the washer.
- **Dispense Precision:** This test measures the variability of volumes dispensed from tube to tube across the manifold.
- **Buffer Switching:** This test measures the variability of volumes dispensed from tube to tube across the manifold when using buffer switching.
- **Vacuum Filtration Evacuation Efficiency:** When applicable, this test measures the total residual volume of the plate after evacuation to verify it is performing to specifications.
- **Verify Sensor Test.** Compares the ultrasonic level sensor's measurement precision against a microplate absorbance reader's determination to ensure accurate, repeatable volume-level detection.

Washer Qualification Tests:

- Dispense Precision (96) on page 157
- Dispense Precision Test (192) on page 161
- Evacuation Efficiency Test (96) on page 158
- Evacuation Efficiency Test (192) on page 162
- Buffer Switching Dispense Test on page 160
- Vacuum Filtration Evacuation Efficiency Test on page 165

Qualification Schedule

The following schedule defines the factory-recommended intervals for verification tests for an instrument used two to five days a week. The schedule assumes that the 405 LS is properly maintained as outlined in the Recommended Maintenance Schedule on page 119.

■ **Note:** An instrument qualification package (PN 1170543) is available for purchase. The package contains thorough procedures for performing Installation Qualification, Operational Qualification and Performance Qualification (IQ-OQ-PQ) and preventative maintenance (PM). Extensive Checklists and Logbooks are included for recording results. Contact your local dealer for more information.

Tests	IQ	OQ	PQ
	Initially	Annually	Monthly
Unpacking, Installation, and Setup	✓		
Enable/Test System Sensors	✓	✓	
System Self Test and Checksum Test	✓	✓	✓
Shake Test		✓	
Ultrasonic Cleaner Test		✓	
Washer Evacuation Efficiency Test		✓	✓
Washer Dispense Precision Test		✓	✓
Vacuum Filtration Evacuation Test		✓	✓
Buffer Switching Dispense Test		✓	
Verify™ Sensor Test		✓	
Run Assay			✓

■ **Important!** The risk factors associated with your assays may require that the Operational and Performance Qualification procedures be performed more or less frequently than shown above.

System Self-Test, Verify Information

Perform these steps to verify software information and run a system self-check:

Prerequisite: When controlling the instrument with the LHC, ensure that it is attached to the host computer and turned on, and then launch the LHC software.

To run the System Self-Test:

LHC	Keypad
Select Tools>Instrument Utilities>General Settings . Under Instrument Functions , click Perform Self-check .	<ol style="list-style-type: none"> 1. Select UTILS at the main menu. 2. Select TESTS. 3. Select SLFCHK.

Test Results:

- If the test passes, a “passing” message appears.
- If the test fails, an error code displays. If this happens, find the error code in the 405 LS Operator’s Manual to determine its cause. If the problem is something you can fix, turn off the instrument, fix the problem, and then turn the instrument back on and re-run the test. If the problem is not something you can fix, contact BioTek’s Technical Assistance Center.

Record Basecode

Record the software part number and version installed on the 405 LS.

LHC	Keypad
<ol style="list-style-type: none"> 1. Select Tools>Instrument Utilities 2. Select the Software tab and from the Instrument Software Information section record the <ul style="list-style-type: none"> • Software Version and part number 	<ol style="list-style-type: none"> 1. Select UTILS 2. Select TESTS 3. Select SFTWR 4. Select WASHER and record the Software part number and version.

- ✓ Use the OQ Checklist to confirm that the software information is correct and the system self-test passed.

Sensor Test: Fluid, Waste, Plate Detection

These tests simulate an error condition for the fluid and waste alert sensors and plate detection, when applicable.

1. Test the Fluid Supply Sensor

1. Remove the lid on the fluid supply bottle (Buffer valve A, when applicable) and lift the internal tube up and out of the fluid.
2. Run W-DAY_RINSE (DAY_RINSE onboard) to bleed the fluid lines.
3. Put a plate on the carrier and run a dispense protocol, e.g. QC_96_DISP_TEST.
4. Look for air moving through the tubing to the washer and wait for the alarm. The instrument should display a fluid error, like 1500 or 1501.

2. Test the Waste Level Sensor

1. Turn the waste bottle upside down.
2. Run an aspirate protocol, e.g. QC_96_EVAC_TEST.

The instrument should beep and display the expected error code, 1401.

3. Test the Plate Detection Sensor (Verify™ Technology ("Q") models only)

1. With plate carrier empty, **Run** any predefined wash protocol.

The instrument should beep and display the expected error code, 1737: no plate detected.

Ultrasonic Cleaner Test

Perform this test to verify that the cleaner is operating properly.

1. Fill a supply bottle with one liter of deionized water. Buffer Switching models need two bottles connected to valves A and B.
2. Select **Quick>Sonic** from the main menu. Set the Duration to 002 (2 minutes).
3. Run the program.
4. While the AutoClean program is running, the ultrasonic cleaner should pulse on and off approximately every ten seconds (a 50% duty cycle). While the program is running, listen for the periodic "hissing" sound that indicates the ultrasonic energy is present. Detecting the sound is all that is required to verify that the ultrasonic cleaner is operating properly. After two minutes, the washer will aspirate the fluid and the program will be complete. (Non-Buffer Switching models can press STOP when prompted for a rinse bottle and quit the program.)

If the ultrasonic cleaner does not operate as described above, contact BioTek for assistance.

Liquid Testing the 405™ Microplate Washer LS

Which Tests to Perform?

We recommend that you perform these routine tests before first use (after the IQ) and then monthly:

Washer

- **Dispense Precision Test.** Precision tests measure the variability of volumes dispensed from tube to tube across the manifold.
- **Evacuation Efficiency Test.** Measures the residual volume per well after the aspiration aspect of plate washing. The lower the residuals per well, the better the evacuation efficiency of the washer.

Specially equipped washers: with Buffer Switching and/or Verify™ Technology, perform test annually (starting one year after installation):

- **Annual Buffer Switching Test.** Measures the variability of volumes dispensed from tube to tube across the manifold, for each valve, when the washer is equipped with buffer switching.
- **Verify Sensor Test.** Compares the ultrasonic level sensor's measurement precision against a microplate absorbance reader's determination to ensure accurate, repeatable volume-level detection.

Perform the tests applicable to the installed manifold type and feature set:

If you have:	Run Liquid Test(s):
96-Tube Manifold	Dispense Precision Test (96)
	Evacuation Efficiency Test (96)
192-Tube Manifold	Dispense Precision Test (192)
	Evacuation Efficiency Test (192)
Buffer Switching	Buffer Switching Dispense Test
Vacuum Filtration Module	Vacuum Filtration Evacuation Efficiency (for either 96- or 384-well plates)
Verify™ Technology	Verify Sensor Test

Important Recommendations for All Liquid Tests

Test Solutions

- Using pure deionized water in place of the test solutions is *not* recommended and will likely result in the failure to meet specifications.
- Prepare the solutions the day before you plan to run the tests. This will allow any foam caused by the agitation of solutions containing Tween® 20 to settle.
- BioTek determined the pass/fail specifications for the instrument tests using the recommended test solutions. You may use your own buffer solution instead, but if any tests fail using your own buffer, retry the tests using the recommended solutions.

Plate Reading

- If you are using one of BioTek's keypad-based readers, such as the ELx800 or ELx808, ensure that the reader is **not** running in **Rapid mode**. To check the setting, select **UTIL → READ** and cycle through the options until READ IN RAPID MODE? appears. Set it to **NO**.
- The absorbance of blue dye solutions should be measured at 630/450 (or 405) nm. The BioTek blue dye solution part number is **7773001**.
- The final absorbance for all dye solution concentrations should be in a range between 0.700 and 1.600 OD.

Recording Test Results

- Use the Liquid Test Worksheets at the end of this section for recording data reduction results. If your tests are failing, this information will be useful for BioTek TAC to help diagnose any problems.

Washer Liquid Tests

Dispense Precision Test

Dispense precision is a measure of the variability of volumes dispensed from tube to tube across the manifold. The optical density of the solution in a well is proportional to the total volume of the solution in the well. If the % Coefficient of Variation (%CV) is calculated, the result is a measure of the uniformity of the distribution of dispensed volumes across the manifold. It is the ratio, expressed in percent, of the standard deviation of the distribution of fluid volumes in the wells to the mean value of volume per well. The uniformity of distribution across the manifold improves as the %CV is lowered.

Annual Buffer Switching Test: The dispense test is also conducted for the buffer switching module to ensure that each valve (A, B, C, D) is calibrated to deliver the same volume of fluid.

Evacuation Efficiency Test

The Evacuation Efficiency test measures the **residual volume** (mean residual weight) per well after aspiration is performed. The lower the residual per well, the better the evacuation efficiency of the washer. A known solution is dispensed into all wells of a previously weighed microplate. Aspiration is performed and the plate is re-weighed. The total residual fluid is calculated based on the weight difference, and this value is divided by 96 or 384 as appropriate, to obtain the **mean residual weight**.

In addition, a diagnostic tool is provided for use, if necessary, to identify problem wells: a known dye concentration is dispensed to and evacuated from the wells, and the plate is weighed. Buffer is then dispensed to all wells to bring the volume of fluid to a more optically measurable volume. The optical density (OD) of each well is measured and the background is subtracted to account for scratches on the plate or particulates in a well. Each well's residual volume is calculated using its OD and a calibration factor derived from the mean residual weight and the mean OD of all wells on the plate. It is assumed that 1 mg = 1 μ L of fluid for this calculation.

Predefined Test Protocols

Several 405 LS protocols are shipped onboard the instrument and with the **LHC** and installed on your computer during LHC installation.

Keypad Users: The protocol names onboard the washer do not include the W- prefix and some protocols include the model name, e.g. 405HT or 405Select, when appropriate.

They include the protocols required to perform the Liquid Tests:

Predefined Protocols
W-DAY_RINSE
QC_96_EVAC_TEST
QC_192_EVAC_TEST
QC_96_DISP_TEST
QC_192_DISP_TEST
QC_96_VAC30_TEST
QC_384_VAC10_TEST
Prime_All_Buffers

The files are stored in the LHC's default file location. Unless you have changed the file location:

1.  Click the **Open** button and locate the **405 LS** folder. Choose the 1Buffer or 4Buffer folder to match your instrument's Buffer Switching capability.
2. Open the **Prime and Maintenance** or **QC Protocols** folder.
3. Select the required protocol.

BioTek recommends customizing these predefined protocols, as described in the topic, [Customize the Predefined Protocols](#) on page 41.

Washer Qualification Test Materials

- One new microplate per test to be performed:

Microplate Type	Liquid Tests
Flat-bottom 96-well plates, Corning® Costar #3590 or equivalent	Evacuation Efficiency Test (96)
	Dispense Precision Test (96)
	Annual Buffer Switching Test

Microplate Type	Liquid Tests
Flat-bottom 384-well plates, Corning Costar or equivalent	Evacuation Efficiency Test (192)
	Dispense Precision Test (192)
	Annual Buffer Switching Test
<ul style="list-style-type: none"> 96-well 0.45 µm filter plate, Millipore MSHVN4550 96 or equivalent 384-well 1.2µm filter plate, Millipore MZFCN0W10 or equivalent 	Vacuum Filtration Evacuation Efficiency Test (<i>Use the plate size most commonly used in your lab</i>)

- Precision balance with minimum capacity of 100 g and readability of 0.001 g resolution
- Pipettes and graduated beakers
- Microplate absorbance reader capable of dual wavelength reading at 630/450 nm
- Liquid Test Worksheets at the end of this chapter for recording data and results
- Deionized water
- **Test solutions:**

For this manifold:	Sol. 1	Sol. 2	Sol. 3	Sol. 4
96-Tube	1000 mL	100 mL	1200 mL	n/a
192-Tube	2000 mL	100 mL	n/a	1440 mL

■ These volumes are sufficient for performing the dispense tests and standard and diagnostic Evacuation Efficiency tests. In most cases, enough fluid will be left over to re-run a test, if necessary.

■ If you will be performing the annual OQ for the external **Buffer Switching** module, you will need several additional liters of deionized or distilled water.

■ **Verify™ Technology** ("Q" models): if you will be qualifying level sensor performance as part of the annual OQ, mix up another 200 mL of **Solution #3** to run that test: Qualify the Verify™ Technology Sensor on page 167.

Test Solutions

Solution #1: Buffer Solution		
Pipette 1 mL Tween 20® into 1 liter (1000 mL) of deionized or distilled water and mix well.	or	Pipette 10 mL of BioTek Wetting Agent* into 1 liter of deionized or distilled water and mix well.

* BioTek Solution #1 100X Concentrate Wetting Agent 125 mL (PN 7773002) contains 10% Tween 20 in deionized water and 0.01% Sodium Azide as a preservative.

SOLUTION #2: Residual Test Solution		
Mix 100 mL of Solution #1 with 0.050 grams of FD&C #1 blue dye.	or	Mix 90 mL of Solution #1 with 10 mL of BioTek Blue Test Dye*.

* BioTek Solution #2 10X Concentrate Blue Test Dye 125 mL (PN 7773001) contains 5 grams per liter FD&C Blue #1, 0.1% Tween 20 in deionized water and 0.01% Sodium Azide as a preservative.

SOLUTION #3: Dispense Precision Solution for 96-Tube manifolds
Mix 1180 mL of deionized or distilled water with 20 mL of Solution #2 .

SOLUTION #4: Dispense Precision Solution for 192-Tube manifolds
Mix 1420 mL of Solution #1 with 20 mL of Solution #2 .

Dispense Precision Test (96)

- This test is designed for **96-Tube** manifolds. Find the Dispense Precision Test (192) on page 161.
- Find a list of the supplies you will need at Materials on page 155.
- **Save the plate!** When this test is complete, use the filled plate to perform the Evacuation Efficiency Test.
- **Keypad Users:** The protocol names onboard the washer do not include the W- prefix and some protocols include the model name, e.g. 405HT or 405Select, when appropriate.

1. Fill a supply bottle with 2 liters of deionized or distilled water; Buffer Switching units use buffer valve A. Run the **W-DAY_RINSE** protocol two or three times to prime the fluid lines and manifold.

2. Fill a supply bottle with 1200 mL of **Solution #3**; Buffer Switching units use buffer valve A.
3. Run **W-DAY_RINSE** again to prime the washer with the solution.
4. Place a new 96-well microplate on the balance and zero the balance.
5. Place the plate on the carrier and run the **QC-96_DISP_TEST**. This protocol dispenses 300 µL of solution to each well of the plate. It does not evacuate the solution.
6. When the protocol is completed, carefully remove the plate. Place the plate on the balance and record the **Total Dispense Weight**.
7. Read the plate in an optical reader (blank on air), using the dual-wavelength method (630 nm - 450 nm), then print or export the results.
8. Use the **Dispense Precision Test Worksheet** to perform data reduction:

Tip: If you have a spreadsheet software program, enter/export all 96 values into a spreadsheet and apply your program's Standard Deviation function (e.g., Microsoft® Excel's STDEV).

- a. Calculate the **Standard Deviation**.
- b. Calculate the sum of the OD values for all 96 wells, then divide by **96** to determine the **Mean OD** for the plate.
- c. Calculate the **%CV**: (Standard Deviation / Mean OD) * 100.

The %CV should be **<= 3.0**.

If the %CV is *greater than* 3.0, one or more dispense tubes may need to be cleaned. Run **AutoClean**, if available, and/or remove the manifold and use the stylus to clean the dispense tube(s) giving lower-than-average absorbance readings. When finished, re-prime the washer and retry the test.

9. When finished, prime with deionized water to flush out the dye solution.

Evacuation Efficiency Test (96)

- This test is designed for **96-Tube** manifolds. Find the Evacuation Efficiency Test (192) on page 162
- If you tared the balance at the start of the Dispense Precision Test, use the plate from that test here; skip steps 1-3.

Keypad Users: The protocol names onboard the washer do not include the W- prefix and some protocols include the model name, e.g. 405HT or 405Select, when appropriate.

1. Fill a supply bottle with 2 liters of deionized or distilled water. Run the Maintenance program **W-DAY_RINSE** two or three times to prime the tubing and manifold.
2. Place a new 96-well microplate on the balance and zero the balance.
3. Pipette or dispense 150 μ L of **Solution #1** into each well of the microplate.
4. Place the plate on the carrier and run the **QC-96_EVAC_TEST** protocol. This protocol evacuates the wells, leaving a small amount of residual fluid.
5. When the program is completed, remove the plate and weigh it immediately because evaporation will affect the results. This is the **Total Residual Weight** in grams.
6. Visually inspect the plate and note if any wells appear to have considerably more liquid than others.
7. Use the [Evacuation Efficiency Test Worksheet](#) to perform data reduction:
 - Divide the Total Residual Weight by **96** to find the **Mean Residual Weight**.
 - The Mean Residual Weight should be **≤ 0.002 g**.

If the Mean Residual Weight is *greater than* 0.002 g, or if one or more wells appear to have much more liquid than the others, the washer failed the test.

Troubleshoot as follows:

If the test fails once:

- If the problem appears to be related to particular wells, clean those aspiration tubes: run AutoClean and/or remove the manifold and thoroughly clean the tubes with the stylus ([See Remove and clean the washer manifold on page 131](#)). When finished, retry the test.
- Failure of this test is commonly caused by improper aspiration tube placement within the wells, usually because a microplate other than the recommended Corning Costar[®] 96 was used. If you must use a plate *other than* the Corning Costar 96, modify the Aspirate Height, i.e., Z position, or horizontal X or Y position parameters in a copy of the **QC-96_EVAC_TEST** protocol to correct this error. After making this change, retry the test using a new microplate.

If the test fails a second time: Perform the *Evacuation Diagnostic Test*.

Evacuation Diagnostic Test

- Conduct this test if the standard Evacuation Efficiency Test fails **twice**. This test will confirm which aspirate tube(s) may be clogged, or if the plate's alignment or position is the problem.

1. If you have not already done so, repeat steps 2 through 7 of the standard Evacuation Efficiency test, using **Solution #2** for the dispense fluid. Be sure to recalculate the **Mean Residual Weight**.
2. Pipette up to 300 μL of **Solution #1** into each well, on top of the residual solution.
3. Shake the plate to achieve uniform distribution of the remaining dye in each well.
4. Read the plate in an optical reader (blank on air), using the dual-wavelength method (630 nm - 450 nm), then print or export the results.
5. Use the **Evacuation Efficiency Test Worksheet** to perform data reduction:
 - Calculate the sum of the OD values for all wells, then divide by **96** to determine the **Mean OD** for the plate.
 - Divide the Mean OD by the **Mean Residual Weight** (from step 1), to find the **Residual Factor**.
 - For each well, divide its OD value by the Residual Factor to find its **Residual Weight**.

Each well's Residual Weight should be $\leq 0.002 \text{ g}$.

If one or more wells have a Residual Weight *greater than* 0.002 g, review the data to determine which well, or wells, is causing the problem.

- If the problem appears to be related to particular wells, clean the associated aspiration tubes: run **AutoClean** and/or remove the manifold and thoroughly clean the tubes with the stylus. ([See Remove and clean the washer manifold on page 131.](#)) When finished, retry the test.
- If the problem appears to be related to a particular region, edge, or corner of the plate, review the alignment and flatness of the plate on the carrier.

 **Please do not adjust** the carrier adjustment screws! Contact BioTek if you suspect an alignment problem, [contact BioTek TAC](#).

- For additional suggestions, [See Troubleshooting on page 180](#).
- If the test continues to fail, contact BioTek Instruments.

Buffer Switching Dispense Test

This procedure tests all the buffer valves.

- The **Dispense Precision** test must pass before the test for Valves A-D can be performed.

1. Empty the waste bottle now, and then as needed throughout this procedure.
2. Fill each of the supply bottles connected to **Buffer valves A, B, C, and D** with three liters (3000 mL) of deionized water. Place the bottles on a surface level with the 405 LS, i.e., the adjacent (lab bench) area.
3. Run the Maintenance protocol **PRIME_ALL_BFRS** two or three times to prime the fluid lines, manifold, and the valves.

Repeat the following steps for each valve:

1. Edit the applicable dispense protocol, for example, **QC_96_DISP_TEST**, to use the buffer valve currently being tested.
2. Place a new 96- or 384-well microplate on the balance and zero the balance.
3. Place the microplate on the carrier and run the dispense protocol.
4. When the program is finished, carefully remove the plate and weigh it. This is the **Total Dispense Weight** in grams.

The Total Dispense Weight should be:

- **28.8 grams ± 10%** (between 25.92 g and 31.68 g) for the 96-Tube test.
 - **30.72 grams ± 10%** (between 27.65 g and 33.79 g) for 192-Tube test.
 - If the weight falls above this range, the valve may be defective. Contact BioTek.
 - If the weight falls below this range, the valve may be contaminated with fungi or proteins and must be cleaned using an appropriate enzyme, alcohol, or a diluted bleach solution, depending on the contaminant. **See Removing Protein Residuals and Fungi Growth on page 124** in the Maintenance section for suggestions. After cleaning the valve and tubing, retry the test. If the test continues to fail, contact BioTek.
5. Record the results in the applicable worksheet.

Dispense Precision Test (192)

■ This test is designed for the **192-Tube** manifold. Find the Dispense Precision (96) on page 157.

■ Find a list of the supplies you will need at Materials on page 155.

■ **Save the plate!** When this test is complete, use the filled plate to perform the Evacuation Efficiency Test.

1. Fill a supply bottle with 2 liters of deionized or distilled water; Buffer Switching units use buffer valve A. Run **W-DAY_RINSE** two or three times to flush the

fluid lines and manifold.

2. Fill a supply bottle with 1440 mL of **Solution #4**; Buffer Switching units use buffer valve A.
3. Run **W-DAY_RINSE** again to prime the washer with the solution.
4. Place a new 384-well microplate on the balance and zero the balance.
5. Place the plate on the carrier and run the **QC-192_DISP_TEST** protocol. This protocol dispenses 80 µL of solution to each well of the plate. It does not evacuate the solution.
6. When the program is finished, carefully remove the plate. Place the plate on the balance and record the **Total Dispense Weight**.
7. Read the plate in an optical reader (blank on air), using the dual-wavelength method (630 nm - 450 nm), then print or export the results.
8. Use the **Dispense Precision Test Worksheet**, perform data reduction:

Tip: If you have a spreadsheet software program, enter/export all 384 values into a spreadsheet and apply your program's Standard Deviation function (e.g., Microsoft Excel's STDEV).

- a. Calculate the **Standard Deviation**.
- b. Calculate the sum of the OD values for all 384 wells, then divide by 384 to determine the **Mean OD** for the plate.
- c. Calculate the **%CV**: (Standard Deviation / Mean OD) * 100.

The %CV should be **<= 4.0**.

If the %CV is *greater than* 4.0, one or more dispense tubes may need to be cleaned. Run **AutoClean** and/or remove the manifold and use the stylus to clean the dispense tube(s) giving lower-than-average absorbance readings. When finished, re-prime and retry the test.

9. When finished, prime with deionized water to flush out the dye solution.

Evacuation Efficiency Test (192)

- This test is designed for the **192-Tube** manifold. Find the Evacuation Efficiency Test (96) on page 158.

- If you tared the balance at the start of the Dispense Precision Test, use the plate from that test here; skip steps 1-3.

1. Fill a supply bottle with 2 liters of deionized or distilled water. Run the **W-DAY_RINSE** protocol two or three times to prime the fluid lines and manifold.
2. Place a new 384-well microplate on the balance and zero the balance.
3. Pipette or dispense 80 μ L of **Solution #1** into each well of the microplate.
4. Place the plate on the carrier and run the **QC-192_EVAC_TEST**. This protocol evacuates all of the wells, leaving a small amount of residual fluid.
5. When the program is completed, remove the plate and weigh it immediately because evaporation will affect the results. This is the **Total Residual Weight** in grams.
6. Visually inspect the plate and note if any wells appear to have considerably more liquid in them than others.
7. Use the **Evacuation Efficiency Test Worksheet** to perform initial data reduction:
 1. Divide the Total Residual Weight by **384** to find the **Mean Residual Weight**.
 2. The Mean Residual Weight should be **≤ 0.002 g**.

If the Mean Residual Weight is *greater than* 0.002 g, or if one or more wells appear to have much more liquid than the others, the washer failed the test.

Troubleshoot as follows:

If the test fails once:

- If the problem appears to be related to particular wells, clean those aspiration tubes: run AutoClean and/or remove the manifold and thoroughly clean the tubes with the stylus (**See Remove and clean the washer manifold on page 131**). When finished, retry the test.
- Failure of this test is commonly caused by improper aspiration tube placement within the wells, usually because a microplate other than the recommended Corning Costar[®] 384 was used. If you must use a plate *other than* the Corning Costar 384, modify the Aspirate Height, i.e., Z position, or horizontal X or Y position parameters in a copy of the **QC-192_EVAC_TEST** protocol to correct this error. After making this change, retry the test using a new microplate.

If the test fails a second time: Perform the *Evacuation Diagnostic Test (192)*.

Evacuation Diagnostic Test (192)

- Conduct this test if the standard Evacuation Efficiency Test fails **twice**. This test will confirm which aspirate tube(s) may be clogged, or if the plate's

alignment or position is the problem.

1. If you have not already done so, repeat steps 2 through 7 of the standard Evacuation Efficiency test, using **Solution #2** for the dispense fluid. Be sure to recalculate the **Mean Residual Weight**.
2. Pipette up to 80 μL of **Solution #1** into each well, on top of the residual solution.
3. Shake the plate to achieve uniform distribution of the remaining dye in each well.
4. Read the plate in an optical reader (blank on air), using the dual-wavelength method (630 nm - 450 nm), then print or export the results.
5. Using the **Evacuation Efficiency Test Worksheet**, perform data reduction:
 - Calculate the sum of the OD values for all wells, then divide by **384** to determine the **Mean OD** for the plate.
 - Divide the Mean OD by the **Mean Residual Weight** (from step 1), to find the **Residual Factor**.
 - For each well, divide its OD value by the Residual Factor to find its **Residual Weight**.

Each well's Residual Weight should be $\leq 0.002 \text{ g}$.

If one or more wells have a Residual Weight *greater than* 0.002 g, review the data to determine which well, or wells, is causing the problem.

- If the problem appears to be related to particular wells, clean the associated aspiration tubes: run **AutoClean** and/or remove the manifold and thoroughly clean the tubes with the stylus. ([See Remove and clean the washer manifold on page 131.](#)) When finished, retry the test.
- If the problem appears to be related to a particular region, edge, or corner of the plate, review the alignment and flatness of the plate on the carrier.

 **Please do not adjust** the carrier adjustment screws! Contact BioTek if you suspect an alignment problem, [contact BioTek TAC](#).

- For additional suggestions, [See Troubleshooting on page 180](#).
- If the test continues to fail, contact BioTek Instruments.

Vacuum Filtration Evacuation Efficiency Test

*This test is designed for the 405 LS with the Vacuum Filtration accessory. Install the vacuum filtration plate carrier to perform the test. Make sure the instrument setting for **Plate Carrier** is set correctly. Use the plate size most commonly used in your lab.*

■ Perform this test during the initial and annual **OQ** and the **monthly PQ**.

1. Fill a supply bottle with 2 L (two liters) of **deionized water**. Run **W-DAY_RINSE** to prime the fluid lines and manifold.
2. Place a new microplate on the balance and zero the balance:
 - 96-well 0.45 µm filter plate: Millipore MSHVN4550 96 is recommended.
 - 384-well 1.2µm filter plate: Millipore MZFCN0W10 is recommended.
3. Run the predefined protocol to first dispense deionized or distilled water into each well of the microplate and then evacuates the wells:

Plate	Predefined Protocol	Volume	Vacuum Time
96-well	QC-96_VAC30_TEST	300 µL/well	30 seconds
384-well	QC-384_VAC10_TEST	80 µL/well	10 seconds

4. When the protocol is finished, remove the plate, and blot the bottom of the plate on a paper towel to remove any droplets.
5. Weigh the plate immediately. This is the **Total Residual Weight**, in grams.
6. Visually inspect the plate and note if any wells appear to have considerably more liquid in them than others.
7. Use the “Vacuum Filtration Evacuation Efficiency Test” worksheet at the end of this chapter to record the results:

Residual Weight should be:

- **<= 1.2 grams** for a 96-well plate;
- **<= 4.0 grams** for a 384-well plate.

■ While BioTek recommends using the Millipore filter-bottom plate listed above in this test, you may substitute other manufacturers’ filter-bottom plates that you are familiar with. However, using a substitute plate **may vary your test results**.

If the Residual Weight is greater than specified, the washer failed the test. Make sure a tight seal was maintained between the filter plate and plate carrier:

- A new, defect-free filter plate was used.
- The vacuum filtration plate carrier's gasket is clean and has not been damaged by previous use or mishandling.

Correct these conditions and rerun the test or contact BioTek TAC for assistance.

Qualify the Verify™ Technology Sensor

If applicable to your 405 LS ("Q" models), BioTek recommends performing this procedure annually to ensure the Verify Technology level sensor is meeting performance specifications.

Required Materials:

- Precision digital balance with a capacity of 400 g and readability of 0.01 g resolution
- Absorbance microplate reader
- 200 mL **Solution #3**: Dispense Precision solution. This volume is sufficient for two test runs. **See Washer Qualification Test Materials on page 155.**
- BioTek's 405 LS IQ-OQ-PQ procedure or operator's manual CD and a spreadsheet program compatible with Microsoft® Excel®.

Prerequisites:

Important: Mix the dye solution, fill a buffer bottle attached to the washer and fully prime the system.

If you purchased the 405 LS IQ-OQ-PQ procedure:

- If you have Gen5™, create a new experiment with the Gen5 Verify Technology protocol (VerifyCal.prt) shipped with the IQOQPQ procedure.

Otherwise, open the Excel spreadsheet provided on the 405 LS Operator's Manual CD in preparation for recording and calculating test results.

Run Verify Test Plate Alignment:

To make sure the 405 LS is correctly calibrated for the Verify Test Plate:

LHC

1. Select **Tools>Instrument Utilities>Verify Manifold>Configure Utilities.**
2. Put the test plate on the carrier and click **Test Plate Alignment.**

This process updates configuration data needed to successfully run the Verify routine.

Perform qualification procedure:

1. Put the Verify Test Plate on the balance and tare the balance.
2. Put the test plate on the carrier, begin the test:

LHC

1. Select **Tools>Instrument Utilities>Verify Manifold>Configure Utilities.**

LHC

2. Click the link to [Perform the **Sensor Calibration**](#).
3. At the first pausing message, weigh the plate and record the **Aspirate Weight** (W_A) value.

- When using Gen5, the spreadsheet does not open until the second read is done. Jot down the weight for later entry in the spreadsheet.
4. Use the absorbance reader to read the plate at 630 nm and 450 nm.
 - If you do not have Gen5, copy and paste the Delta transformation reading results (630 nm - 450 nm) into the spreadsheet provided: in the [Supporting Data](#) section of the worksheet, paste data into the **Da (aspirate distance)** grid.
 - If you have Gen5, the reading results will be reported later in the Power Export.
5. Put the Verify Test Plate back on the 405 LS's carrier and select **OK** in the pausing message to continue.
6. At the second pause, weigh the plate again and record the **Dispense Weight** (W_D) value.
7. Use the absorbance reader to read the plate at 630 nm and 450 nm. Gen5 users: select **OK**.
 - If you do not have Gen5, copy and paste the Delta transformation reading results (630 nm - 450 nm) into the spreadsheet provided: in the [Supporting Data](#) section, paste data into the **Dd (dispense distance)** grid.
 - If you have Gen5, the Power Export containing the reading results opens. Fill in the other data fields for weight and calibration data (as described below).
8. Put the test plate back on the 405 LS's carrier and select **OK** in the second pausing message.

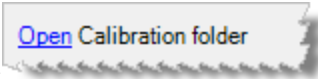

[Open Calibration folder](#)

Format and evaluate test results:

9. Open the [Calibration Data](#) .txt file named in the final message (with the date and time of execution) in the [Calibration Data](#) folder in the LHC folder structure.¹
10. Copy and paste **all** the data from the .txt file into the spreadsheet provided:

¹LHC users: The default location for this report is the Windows Common App Data folder (e.g. C:\ProgramData) \BioTek\Liquid Handling Control *version*#\ManifoldTests\SN_##\Calibration Data. Touch screen: transfer the memory stick to your PC.

- Select Ctrl+A and Ctrl+C
- Select the [From405](#) tab and paste (Ctrl+V) all the data into the grid beginning at worksheet cell **A1**.

If the Sigma Error is *greater than* 9 µL, the sensor failed the test.

Troubleshoot as follows:

- Review the test procedure: Was the Verify Test Plate seated correctly during testing on the washer and the reader, with well A1 in the correct orientation? Was there a long delay between steps, allowing fluid to evaporate?
- Inspect the plate for damage. Replace the plate (according to the prescribed [procedure](#)) if the plate is cracked, warped, scratched, or otherwise damaged.
- Inspect the washer components:
 - Is the Verify sensor's collimator clean and properly installed? (Clean the Verify™ Level Sensor on page 133).
 - Have the plate carrier feet been adjusted? Contact BioTek TAC for recalibration service.

Take corrective action if possible and rerun the test. If it fails again, contact BioTek TAC for guidance.

Dispense Precision Test Worksheet

96-Tube Manifold

Serial Number:	
----------------	--

Calculations	
Standard Deviation: (calculate using spreadsheet program)	
Mean OD: (sum of all wells ÷ number of wells)	
% Coefficient of Variation: ((Standard Deviation ÷ Mean OD) x 100)	
% CV <= 3.0?	<input type="checkbox"/> Pass <input type="checkbox"/> Fail

Date:	
Test Performed By:	

Evacuation Efficiency Test Worksheet

96-Tube Manifold

Serial Number:	
----------------	--

Standard Test	
Total Residual Weight:	g
Verification that wells are consistent in appearance:	<input type="checkbox"/> Pass <input type="checkbox"/> Fail
Mean Residual Weight (Total Residual Weight ÷ 96):	g
Mean Residual Weight ≤ 0.002 g?	<input type="checkbox"/> Pass <input type="checkbox"/> Fail

Evacuation Diagnostics Test (check here <input type="checkbox"/> if not performed)	
Mean OD for the plate (Sum of all wells ÷ 96):	
Residual Factor (Mean OD ÷ Mean Residual Weight):	
Calculate the Residual Weight for each well: well OD ÷ Residual Factor	
Every Residual Weight per well ≤ 0.002 g?	<input type="checkbox"/> Yes <input type="checkbox"/> No

Date:	
Test Performed By:	

Dispense Precision Test Worksheet

96-Tube Manifold Annual Buffer Switching Test

Serial Number:	
----------------	--

Calculations for Valve A	
Standard Deviation:	
Mean OD (Sum of all wells ÷ Number of wells):	
% CV (Standard Deviation ÷ Mean OD x 100):	
% CV ≤ 3.0?	<input type="checkbox"/> Pass <input type="checkbox"/> Fail

Calculations for Valves A-D (Annual OQ only, check here <input type="checkbox"/> if not performed)		
	Total Dispense Weight	28.8 g ±10%? (25.92 g - 31.68 g)
Valve A	grams	<input type="checkbox"/> Pass <input type="checkbox"/> Fail
Valve B	grams	<input type="checkbox"/> Pass <input type="checkbox"/> Fail
Valve C	grams	<input type="checkbox"/> Pass <input type="checkbox"/> Fail
Valve D	grams	<input type="checkbox"/> Pass <input type="checkbox"/> Fail

Date:	
Test Performed By:	

Dispense Precision Test Worksheet

192-Tube Manifold

Serial Number:	
----------------	--

Calculations	
Standard Deviation: (calculate using spreadsheet program)	
Mean OD: (sum of all wells ÷ number of wells)	
% Coefficient of Variation: ((Standard Deviation ÷ Mean OD) x 100)	
% CV ≤ 4.0?	<input type="checkbox"/> Pass <input type="checkbox"/> Fail

Date:	
Test Performed By:	

Evacuation Efficiency Test Worksheet

192-Tube Manifold

Serial Number:	
----------------	--

Standard Test	
Total Residual Weight:	g
Verification that wells are consistent in appearance:	<input type="checkbox"/> Pass <input type="checkbox"/> Fail
Mean Residual Weight (Total Residual Weight ÷ 384):	g
Mean Residual Weight ≤ 0.002 g?	<input type="checkbox"/> Pass <input type="checkbox"/> Fail

Evacuation Diagnostics Test (check here <input type="checkbox"/> if not performed)	
Mean OD for the plate (sum of all wells ÷ 384):	
Residual Factor (Mean OD ÷ Mean Residual Weight):	
Calculate the Residual Weight for each well: well OD ÷ Residual Factor	
Every Residual Weight per well ≤ 0.002 g?	<input type="checkbox"/> Yes <input type="checkbox"/> No

Date:	
Test Performed By:	

Dispense Precision Test Worksheet

192-Tube Manifold Annual Buffer Switching Test

Serial Number:	
----------------	--

Calculations for Valve A	
Standard Deviation:	
Mean OD (Sum of all wells ÷ Number of wells):	
% CV (Standard Deviation ÷ Mean OD x 100):	
% CV ≤ 4.0?	<input type="checkbox"/> Pass <input type="checkbox"/> Fail

Calculations for Valves A-D (Annual OQ only, check here <input type="checkbox"/> if not performed)		
	Total Dispense Weight	30.72 g ± 10%? (27.65 g – 33.79 g)
Valve A	grams	<input type="checkbox"/> Pass <input type="checkbox"/> Fail
Valve B	grams	<input type="checkbox"/> Pass <input type="checkbox"/> Fail
Valve C	grams	<input type="checkbox"/> Pass <input type="checkbox"/> Fail
Valve D	grams	<input type="checkbox"/> Pass <input type="checkbox"/> Fail

Date:	
Test Performed By:	

Vacuum Filtration Evacuation Efficiency Test

96-Well Filter Plates

Serial Number:	
----------------	--

Test Results	
Verification that wells are consistent in appearance:	<input type="checkbox"/> Pass <input type="checkbox"/> Fail
Residual Weight:	g
Residual Weight: ≤ 1.2 g	<input type="checkbox"/> Pass <input type="checkbox"/> Fail

Date:	
Performed By:	
If required, Reviewed/Approved By:	

Vacuum Filtration Evacuation Efficiency Test

384-Well Filter Plates

Serial Number:	
----------------	--

Test Results	
Verification that wells are consistent in appearance:	<input type="checkbox"/> Pass <input type="checkbox"/> Fail
Residual Weight:	grams
Residual Weight: ≤ 4.0 g	<input type="checkbox"/> Pass <input type="checkbox"/> Fail

Date:	
Performed By:	
If required, Reviewed/Approved By:	

Troubleshooting

This chapter provides guidelines for error recovery and troubleshooting performance problems.

Troubleshooting	180
General Operation Troubleshooting	182

Troubleshooting

Error recovery:

First Response: Run a System Test (restart the instrument) to give the instrument an opportunity to restore its initial settings and communication capability.

LHC Users: Reboot your Computer and Instrument: When you cannot run a system test, e.g. LHC is not responding, or when running a system test doesn't resolve the issue, turn off your computer and 405 LS, check all the cabling, i.e. make sure your USB cable is in good condition and is properly connected to the PC and instrument, and then, power them on. This should refresh the devices and reset communication parameters.

Error Codes

To find a specific error code:

- Software Error Codes on page 200 (6000-6100) - protocol errors
- System Error Codes on page 192 (0000-A500) - hardware errors

Most error conditions generate an error message that is displayed on the computer screen or keypad.

6045	Serial write error
------	--------------------

LHC Users: A potentially common error, especially when using the Predefined Protocols, a "serial write" error, is easily fixed by correcting the [COM port setting](#) defined in the protocol.

810D	To communicate, instrument must be at main menu/Home screen.
------	--

LHC Users: Similarly, the 810D message appears when the instrument is busy, for example when AutoPrime is running. The LHC can only talk to the instrument when its main menu is displayed. Press the **Stop** button, if desired, to end the current process and reestablish communication with the LHC.



Technical Note: Only one of the two communication ports (COM port) on the instrument can be used at a time. They cannot be used simultaneously. You can use USB to connect the 405 LS to the computer or the RS232 serial port to connect to a BioStack or similar robotic device. But you cannot use both ports simultaneously, i.e. make sure only one cable is plugged in at a time.

Keypad Control: When the BioStack is connected to your 405 LS, you are controlling both instruments using the keypad. Before connecting the 405 LS to your computer to download basecode or for other reasons, you must first

disconnect the BioStack from the 405 LS and change the Instrument Setting for the BioStack: Press **Setup Menu> BINSTK> CONF>MANUAL**.

General Operation Troubleshooting

This is a list of potential performance problems and their solutions.

Startup

Problem	Possible Cause	What To Do
Display (Touch screen) not on.	Power cord not plugged in.	Check power connection.
Carrier/manifold position error.	Manifold or carrier is being obstructed.	Remove obstruction.
	Motor, sensor, or electrical problem.	Turn instrument off, wait at least 15 seconds, and turn it back on. If the self-test does not pass, contact BioTek TAC.
	Misaligned carrier or manifold.	Contact BioTek TAC.
	Incorrect manifold setting.	Make sure the manifold setting matches the installed manifold. LHC: Tools>Instrument Utilities>Washer Touch screen: Instrument>Options

Microplate Scratches

Problem	Possible Cause	What To Do
Scratches on microplate bottom.	Microplate dispense or aspiration height adjustment too low.	Change the Dispense or Aspirate height, the Z-axis position.
	Microplate not properly seated or strips not level.	Reseat microplate in carrier or strips in holder. Make sure the carrier is clean. Try a different microplate or strip holder. If the problem is unresolved, the carrier may have to be realigned. Contact BioTek TAC.

Washer Problems

Vacuum Pump

Problem	Possible Cause	What To Do
Vacuum pump does not start, or shakes when turned on.	Vacuum pump is not turned on.	Flip the switch on the side of the vacuum pump to turn it on.
	Vacuum pump accessory cable not installed correctly.	Plug the vacuum pump accessory cable into the back of the instrument, Accessory Outlet.
	Too much residual vacuum force for pump.	Release the vacuum by loosening the waste bottle stopper. Reconnect and start again.
	Blown fuse in accessory outlet.	
Increase vacuum dissipation delay. LHC: Tools>Instrument Utilities>Vacuum Dissipation Delay. Keypad: Setup Menu>→ADVANC→VACDIS		
Replace fuse (PN 46055), Replace the Vacuum Pump Fuse on page 145		
Repeated blown fuses.	Vacuum Dissipate Delay is set too low for the volume of the waste bottle.	See above. If not enough time is allowed for the vacuum to dissipate, the pump will try to start while it is under a vacuum. The pump draws excessive current and blows the fuse.
	Pump has been flooded.	Remove the head from the pump and inspect it for corrosion, crystalline buildup or liquid. Contact BioTek TAC for information on pump rebuilding kits.

Fluid Aspiration

Problem	Possible Cause	What To Do
Poor or uneven aspiration.	Insufficient or no vacuum.	Firmly seat the waste bottle covers. Ensure tubing is connected properly. Check all external tubing and in-line filter for kinks or clogs. If you are using an in-line vacuum filter, it may need to be replaced.
		With the vacuum pump on, remove the vacuum pump tubing from the back of the instrument. Put your finger over the port; if there is no vacuum, contact BioTek TAC.

Problem	Possible Cause	What To Do
	Clogged aspiration tubes on the washer manifold.	Remove and clean the washer manifold on page 131 Make sure the microplate carrier is level and the waste valve is not touching the bench.
	Aspirate height adjustment too high or too low.	Change the aspiration height (Z-axis position) in the protocol.
	Vacuum pump failure.	Contact BioTek TAC.
Uneven aspiration of water buffer. Some wells left full.	No surfactant in the buffer, such as Tween [®] 20.	Add surfactant to the buffer. If this is not possible, continue below.
	Insufficient vacuum.	BioTek offers a high-flow pump for assays using only water for the wash fluid. Contact BioTek for more information.
	Protocol settings not optimized.	Optimize protocols to improve evacuation on page 40
	Aspiration tubes not properly positioned horizontally in wells.	If none of the tubes are bent, try adjusting the horizontal aspirate position (X-/Y-axis) in the protocol.
	Microplate not level in carrier, or strips not level in holder.	Reseat microplate in carrier or strips in holder. Make sure the carrier is clean. Try a different microplate or strip holder. If the problem is unresolved, the carrier may have to be realigned. Contact BioTek TAC.
Too much residual left in wells after aspiration.	Clogged vacuum filter.	If you are using an in-line vacuum filter (PN 49943), the filter may need to be cleaned or replaced.
	Waste bottle cover not properly sealed or fittings not properly connected.	Firmly seat the waste bottle stopper. Make sure tubing is connected properly.
	Manifold out of alignment or not moving freely.	Check for obstructions. If none are found, contact BioTek TAC.

Problem	Possible Cause	What To Do
	Protocol requires optimization.	Optimize protocols to improve evacuation on page 40.
	Aspirate tubes are bent.	Contact BioTek TAC.

Fluid Delivery

Problem	Possible Cause	What To Do
Unable to dispense fluid.	Clogged fluid filter.	Clean the fluid filter inside the supply bottle.
	Inlet tube not connected.	Make sure all tubing is connected properly. Check all external tubing for kinks or clogs.
	Clogged valve	Create a protocol with several small primes, e.g. 10 mL, to try to unclog valve.
	Clogged dispense tubes on the washer manifold.	Remove and clean the washer manifold on page 131
	No wash or rinse fluid.	Fill bottles with appropriate fluid. Ensure bottles are clean and do not contain particles or organic material.
Unable to dispense fluid.	System not primed. Large air pockets in tubing.	Run W-DAY_RINSE.
	Insufficient suction, clogged tubing, or faulty valve.	Perform Washer Maintenance; If the problem persists, contact BioTek TAC.
Plate overfills (floods).	Dispense height too high. The aspirate tubes are too far above the wells to prevent overflow.	Lower the dispense height (Z-axis position) in the protocol.
	Dispense flow rate too low.	Define a higher dispense Flow Rate in the protocol.
	Cell wash flow rate 1 or 2 is used with 384-well plates.	Specify a non-CW dispense Flow Rate when using 384-well plates.
	Aspiration tubes hit bottom of trough during Prime or Maintenance.	Manifold may not be properly seated or mounted. Contact BioTek TAC.

Problem	Possible Cause	What To Do
	In-line vacuum filter plugged.	Replace or remove the in-line vacuum filter.
	Loose covers on waste bottles.	Firmly tighten waste bottle covers.
	Dispense rate too fast for volume selected.	Specify slower dispense Flow Rate or lower volume.
	Faulty vacuum pump.	Contact BioTek TAC.
	Insufficient or no vacuum.	Firmly seat the waste bottle covers. Check all external tubing for kinks or clogs. When the program begins, you should be able to hear the vacuum pump turn on. If it is not turning on, contact BioTek TAC. If the vacuum pump turns on, remove the vacuum tubing from the back of the instrument and put your finger over the port. If there is no vacuum, contact BioTek TAC.
Uneven dispensing of fluid; wells not filled.	Clogged dispense tubes on the washer manifold.	Remove and clean the washer manifold on page 131
	Manifold or tubing not adequately primed.	Run W-DAY_RINSE once or twice.
	Dispense flow rate too low. Flow rate 1 or 2 CW is used with 384-well plates.	Define a higher dispense Flow Rate.
	Microplate aspiration height adjustment too high or too low.	Change the aspirate height (Z-axis position) in the protocol.

Fluid Leakage

Problem	Possible Cause	What To Do
Fluid leaking from manifold.	Defective seals.	Contact BioTek TAC
	Aspiration tubes only: vacuum too low.	Check waste connector tubes; make sure they are properly connected. If you are using an in-line vacuum filter, check the filter for clogging, and replace if necessary. Check seal of waste bottle covers. Check for air leaks in the waste tubing and

Problem	Possible Cause	What To Do
		bottles. Use a slower Aspiration Travel Rate.
	Uneven (not level) surface.	Make sure the surface the washer sits on is perfectly level.
Fluid leaking from underneath the instrument.	Defective tubing connector or inlet tubing.	Contact BioTek TAC.
	Leaking valve.	Contact BioTek TAC.
Fluid leaking from external tubing connector.	Defective connector.	Replace connector.
	Worn tubing.	Replace tubing or cut back tubing one inch (to remove worn section).
	Worn seal (inlet or vacuum fitting).	Replace filter or seal.

Microplate Carrier Movement

Problem	Possible Cause	What To Do
Aspiration tubes not entering wells correctly.	Microplate not properly seated or strips not level.	Reseat microplate in carrier or strips in holder. Make sure the carrier is clean. Try a different microplate or strip holder. If the problem is unresolved, the carrier may have to be realigned. Contact BioTek TAC.
	Aspirate tubes position is too wide for a movement.	Change the horizontal, X- or Y-axis aspirate position in the protocol.
	Aspirate tubes bent.	Contact BioTek TAC.
Loud, annoying noise during operation.	Plate carrier is rubbing against glide strip.	Thoroughly clean the microplate carrier and exterior surface as recommended in the maintenance procedure.
384-well plates not properly washed.	Microplate carrier not moving correctly in the	Clean the plate carrier system. If problems persist, contact TAC for assistance cleaning the carrier transport arm.

Problem	Possible Cause	What To Do
	Y-axis.	
Uneven performance.	Plate carrier leveling feet damaged.	Replace plate carrier: contact BioTek TAC for assistance. Note: "Q" model washers with Verify™ Technology must recalibrate the Verify test plate after installing the new carrier.

Washer Manifold Movement

Problem	Possible Cause	What To Do
Manifold position error.	Manifold movement is blocked.	Check orientation of microplate; A1 should be in the left rear corner of the plate carrier as you face the instrument. Check for and remove any obstructions. Ensure the manifold is installed properly.
	Incorrect manifold selected.	Make sure the washer manifold setting matches the installed manifold (96-, 192--tube). LHC: Tools>Instrument Utilities>Washer>Manifold Selection. Keypad: Setup Menu> → >MANIF

Communication Errors

Here are some guidelines for troubleshooting communication errors between the 405 LS and the computer.

6045: A potentially common error, especially when using the Predefined Protocols, a "serial write" error, is easily fixed by correcting the [COM port setting](#).

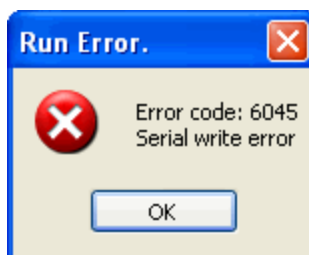

BioStack communication error: when controlling the BioStack with the LHC, make sure the onboard configuration setting is **Manual**.

810D: Similarly, the 810D message appears when the instrument is busy, for example when **AutoPrime** is running. The LHC can only talk to the instrument when its main menu is displayed. Press the **Stop** button on the keypad, if desired, to end the current process and return to the main menu.

Safety first

- To prevent damage to the instrument, always turn OFF the 405 LS or the computer before removing or inserting a communications (serial or USB) cable.

When the computer (PC) won't communicate with the instrument:

1. **Run the system self-test.** All BioTek instruments perform a self-test when turned on. The 405 LS will not communicate if it fails an internal system test. An error message will be displayed when a test fails.
2. **Make sure the USB cable is in perfect condition and properly attached** to the port defined in the [Instrument Settings](#) dialog (e.g. COM 1). Review the LHC Help Topic Select Help>Help Topics and search for "About COM Ports." "About COM Ports" to learn about virtual COM ports when using a USB cable. Correct and reboot both PC and instrument. [Test communication](#).
3. **Confirm that the USB cable was obtained from BioTek.** USB cables are not universal. Contact BioTek customer service to purchase a factory tested cable. After installing a known, good cable, reboot both PC and instrument.

Error Codes

A listing of potential error codes and possible solutions for resolving them.

System Error Codes	192
405 LS-LHC Software Error Codes	200

System Error Codes

Most of these error conditions require technical expertise to correct. Error code 306 and few other exceptions to this rule are listed with remedies in the [Troubleshooting](#) section. A few other errors may be caused by an obvious obstruction to a device's movement or insufficient fluid in a supply vessel. Fix these kinds of errors and restart your instrument to give it an opportunity to clear the error code.

[Contact BioTek Technical Assistance Center \(TAC\)](#) for assistance.

Code	Message	What to do
100	Task was aborted	Restart instrument if this message is unexpected.
210, 220	Carrier X motor didn't find home opto sensor transition Carrier X motor didn't find autocal jig opto sensor transition	Clean the plate carrier, rails, and glide strips, using mild detergent and hot water, 70% isopropyl alcohol or ethanol. Restart the instrument. If the error occurs again, contact BioTek TAC.
211, 221	Carrier Y motor didn't find home opto sensor transition Carrier Y motor didn't find autocal jig opto sensor transition	Run self test. If error reoccurs, contact BioTek TAC.
212, 222	Dispense head motor didn't find home opto sensor transition, Dispense head motor didn't find autocal jig opto sensor transition	Run self test. If error reoccurs, contact BioTek TAC.
213, 223	Wash head motor didn't find home opto sensor transition, Wash head motor didn't find autocal jig opto sensor transition	Run self test. If error reoccurs, contact BioTek TAC.
220	Carrier X motor didn't find autocal jig optical sensor transition.	Service Only. Contact BioTek TAC.
221	Carrier Y motor didn't find autocal jig optical sensor transition.	Service Only. Contact BioTek TAC.

Code	Message	What to do
223	Wash head motor didn't find autocal jig optical sensor transition.	Service Only. Contact BioTek TAC.
300	Carrier X motor interlock safety switch open	Service Only. Contact BioTek TAC.
301	Carrier Y motor interlock safety switch open	Service Only. Contact BioTek TAC.
302	Dispense head motor interlock safety switch open	Service Only. Contact BioTek TAC.
303	Wash head motor interlock safety switch open	Service Only. Contact BioTek TAC.
400	Carrier X motor failed positional verify	Run self test. If error reoccurs, contact BioTek TAC.
401	Carrier Y motor failed positional verify	Run self test. If error reoccurs, contact BioTek TAC.
402	Dispense head motor failed positional verify	Run self test. If error reoccurs, contact BioTek TAC.
403	Wash head motor failed positional verify	Service Only. Contact BioTek TAC.
600-606	Specified motor currently in use	Service Only. Contact BioTek TAC.
700 - 70F	Invalid motor number specified	Service Only. Contact BioTek TAC.
900	Calibration failed. The measured or calculated autocal value is out of tolerance	Service Only. Contact BioTek TAC.
A00	Invalid plate type selected	The currently selected plate type is not supported with the currently installed or requested hardware. If this is not the case, contact BioTek TAC.
C01	Configuration or autocal data missing	Service Only. Contact BioTek TAC.
C02	Checksum mismatch -calculated checksum didn't match saved checksum	Service Only. Contact BioTek TAC.

Code	Message	What to do
C03	Configuration parameter out of range	Service Only. Contact BioTek TAC.
1001	Bootcode powerup checksum test failed	Contact BioTek TAC.
1002	Unknown error in bootcode	Contact BioTek TAC.
1003	Bootcode page program error	Contact BioTek TAC.
1004	Bootcode block size error (not 256)	Contact BioTek TAC.
1005	Invalid processor signature (not 1280,1281,2560,2561)	Contact BioTek TAC.
1006	Bootcode memory exceeded	Contact BioTek TAC.
1007	Invalid slave port	Contact BioTek TAC.
1008	Invalid response from slave	Contact BioTek TAC.
1009	Invalid processor detected	Contact BioTek TAC.
1010	Checksum error downloading basecode	Contact BioTek TAC.
1250	Internal RAM test error on the UI processor	Contact BioTek TAC.
1251	Internal RAM test error on the MC processor	Contact BioTek TAC.
1260	Stack test error on the UI	Contact BioTek TAC.
1261	Stack test error on the MC	Contact BioTek TAC.
1400	No vacuum pressure detected after turning on the vacuum pump	Make sure the vacuum pump is turned on, and not leaking; the waste bottle has not overflowed and its caps are seated correctly. If the pump is not running, the fuse may be blown. But, before replacing the fuse, first try to determine and remedy the cause of the failure. If the pump sounds strained or runs slowly, it may be damaged. Review other related Troubleshooting suggestions.

Code	Message	What to do
1401	The waste bottles should be emptied before continuing	Empty the waste bottles and rerun the protocol.
1402	The requested valve is invalid	Contact BioTek TAC.
1403	Invalid Z-axis offset value	The Magnet Adapter offset (MAGHT) is too high, the "in use" value is missing, or a more serious software problem exists. Make sure the setting is valid , and if so, contact BioTek TAC.
1404	Plate type restricted	This instrument model or the requested device does not support the selected plate type. Edit the protocol to change the plate type .
1405	Z-axis out of range	The requested travel/dispense height cannot be reached. The conflict may be caused by a combination of variables, plate type, Plate Clear or other height settings. Review the protocol parameters and instrument settings to identify a correction.
1407	Invalid step type	The protocol may have been created for a different instrument, it is not compatible with this instrument.
1408	Invalid plate geometry	Contact BioTek TAC.
1409	Invalid plate carrier type	Contact BioTek TAC.
1410	Incompatible hardware	Vacuum filtration requested but either the instrument is in BioStack mode, or this instrument is not configured to support it. Change the BioStack configuration , it is not compatible with the vacuum carrier, or contact BioTek TAC.
1411	Invalid plate carrier	The vacuum filtration carrier must be installed to run this kind of protocol, and the plate carrier setting must represent the currently installed carrier.
1412	Tip clearance error	Contact BioTek TAC.
1413	AutoPrime in progress	Contact BioTek TAC.
1414	AutoPrime aborted	Contact BioTek TAC.

Code	Message	What to do
1415	AutoPrime value out of range	Contact BioTek TAC.
1500	No buffer fluid detected at the start of a wash protocol	Fluid detection errors. Make sure the supply bottle is full and properly connected, the tubing is not kinked, blocked, etc., and the correct port/valve is selected.
1501	No buffer fluid detected before the washer dispense step	
Note:	Running very low density fluids, like alcohol, may generate some of these fluid detection errors because the fluid prohibits the float detector from operating properly. Disable the Fluid sensor (Washer Settings) while using such low density fluids, but be vigilant about monitoring fluid levels.	
1502	The buffer valve selection is invalid	Contact BioTek TAC.
1503	Dispense volume error	Contact BioTek TAC.
1504	No buffer detected flowing through the manifold during an operation	Flow detection errors. Make sure the supply bottle is full and properly connected, the tubing is not kinked, blocked, etc., and the correct port/valve is selected.
1505	No buffer detected at the end of a wash protocol	
1506	The requested carrier Y-axis position is out of range	Contact BioTek TAC.
1507	Internal valve transition error	Contact BioTek TAC.
1508	Pre-dispense volume error	The specified Pre-dispense volume is invalid for this plate type. Edit the protocol.
1509	Low flow 192-tube manifold error	The 192-tube manifold does not support cell wash or low-flow protocols. A wash step mismatch has occurred. Edit the protocol.
1510	Low flow 96-tube manifold error	Contact BioTek TAC.
1511	External Buffer Switching valve module is required	The current protocol is defined to use different valves of the Buffer Switching module, which is not installed. Edit the protocol.
1512	Invalid plate type	The specified plate type is not supported with the current hardware.

Code	Message	What to do
1513	Plate type - manifold conflict	Change the Plate Type to one supported by the manifold. Or, click the Instrument Settings link and make sure they match the physical hardware: Get settings from instrument.
1514	Ultrasound module not connected	The protocol may have been created for a different instrument, according to the instrument's basecode it is not compatible with this instrument. Contact BioTek TAC.
1515	Cell Wash hardware not installed	
1516	Vacuum filtration start or end error	Vacuum pressure is detected in the intermediate waste bottle before or after the run. Contact BioTek TAC.
1517	Vacuum filtration sensor error	Unable to read vac. filtration sensor. This is expected if you are running with very low pressure, in this case disable the sensor. Otherwise, check for leaks, e.g. bottle cap.
1600-160C	The onboard storage space allocated for this function has been used up.	Use the LHC "Manage Memory" control to reallocate space.
160D	Not a valid step	Contact BioTek TAC.
1700-1709	"Q" model level sensor errors	Contact BioTek TAC.
170A-170F	"Q" model level sensor RX errors	Contact BioTek TAC.
1710-1716	"Q" model level sensor RX errors	Contact BioTek TAC.
1717-18	Level sensor X-axis parameter out-of-range	Contact BioTek TAC.
171A-171F	Level sensor initiation errors	Contact BioTek TAC.
1720-1736	Level sensor functional errors	Take action to correct the error, if possible. Otherwise, contact BioTek TAC for assistance.
1737	Plate test did not find plate.	Put a plate on the plate carrier.

Code	Message	What to do
1738-173A	Level sensor functional errors	Take action to correct the error, if possible. Otherwise, contact BioTek TAC for assistance.
2400	Parameter limit exceeded	Contact BioTek TAC.
4000	Program locked so operation denied	Contact BioTek TAC.
4010	Program cannot be erased so delete denied	Contact BioTek TAC.
4020	Bad checksum when reading program from EEPROM	Contact BioTek TAC.
4030	Program not found	Contact BioTek TAC.
4040	Can't save program because no space available	Contact BioTek TAC.
4050	Program run canceled by user	Restart instrument if this message is unexpected.
8100	Communications NAK	Contact BioTek TAC.
8101	Timeout while waiting for serial message data	Contact BioTek TAC.
8102	Instrument busy and unable to process message	Contact BioTek TAC.
8103	Receive buffer overflow error	Contact BioTek TAC.
8104	Checksum error	Contact BioTek TAC.
8105	Invalid structure type in byMsgStructure header field	Contact BioTek TAC.
8106	Invalid destination in byMsgDestination header field	Contact BioTek TAC.
8107	Request object received not supported by instrument	Contact BioTek TAC.
8108	Message Body size exceeds max limit	Contact BioTek TAC.
8109	Max number of requests currently running and cannot run the latest request	Contact BioTek TAC.

Code	Message	What to do
810A	No request running when response request issued	Contact BioTek TAC.
810C	Response for outstanding request not ready yet	Contact BioTek TAC.
810D	To communicate with the LHC, the instrument must be at its Home screen	The LHC can only talk to the instrument when its main menu is displayed. When the instrument is busy, for example when AutoPrime is running, press the Stop button on the keypad, if desired, to end the current process and return to the main menu.
810E	One or more request parameters are not valid	Contact BioTek TAC.
810F	The command was received while the software was not ready to accept that command	Contact BioTek TAC.
A00	Invalid plate type requested	Service Only. Contact BioTek TAC.
A100 - A10F	Software device not available	Service Only. Contact BioTek TAC.
A200	Version strings for multiple microprocessors do not match	Service Only. Contact BioTek TAC.
A301	+5v logic power supply level error	Service Only. Contact BioTek TAC.
A302	+24v system/motor power supply level error	Service Only. Contact BioTek TAC.
A400	Malloc failed	Service Only. Contact BioTek TAC.
A500	Multiple tasks attempted to use display simultaneously	Service Only. Contact BioTek TAC.
A600	Serial EEPROM access error	Service Only. Contact BioTek TAC.
A700	Motor truncation error	Service Only. Contact BioTek TAC.

405 LS-LHC Software Error Codes

Generally, these errors are caused by protocol parameters that conflict with the instrument's onboard settings. The protocol may have been originally created for a different hardware configuration, the 192-tube wash manifold instead of the 96-tube, for example.

Quick Fix: Make sure your **Instrument Settings** accurately reflect your instrument's hardware configuration and then, modify the protocol to fix any invalid parameters. With the 405 LS connected to and communicating with your computer and its main menu displayed on the keypad:

1. Click the [Settings](#) link in the main view.
2. In the **Instrument Settings** dialog, click the instrument link to get the settings from the instrument.
3. Modify the protocol step that generated the error message.

Error Code	Description	Help
6000	General communication error during download.	See Communication Errors on page 188
6001	COM port created by USB converter no longer active	See Communication Port
6002	Invalid basecode part number; instrument is not an 405 LS	Service Only. Contact BioTek TAC.
6003	Invalid Basecode Data Version; basecode needs to be updated	Contact BioTek to obtain latest basecode.
6004	No rows are selected for the specified plate type	Modify the protocol to select a row.
6005	Invalid row selection value (must be 0 or 1)	Contact BioTek TAC.
6006	This instrument can only process 96-well plates	The protocol may have been created for another instrument, change the plate type or select another protocol.
6007	This instrument can only process 1536-well plates	
6008	The 8-tube Syringe Manifold can only be used with 96-well plates	Mismatch between installed hardware and protocol parameters: change the plate type or correct the instrument settings to match the currently installed hardware.

Error Code	Description	Help
6009	The 96-tube single wash manifold can only be used with 96-well plates	
6010	The data is invalid or out-of-range.	Service Only. Contact BioTek TAC.
6011	This step type cannot be downloaded.	Review the limitations to transferring protocols to the instrument, See the LHC Help Topic: <i>Transferring Protocols</i> .
6012	Illegal characters in protocol name	See the LHC Help topic: <i>Define a Protocol</i> .
6013	The protocol name length must be 16 characters or less.	
6016	The volume is out-of-range.	Modify the volume or change the cassette type.
6017	Invalid flow rate.	Learn about the <i>Syringe Dispense Step</i>
6018	Invalid number of pre-dispenses.	Service Only. Contact BioTek TAC. These codes indicate an unexpected software error that cannot be fixed without BioTek support.
6019	Invalid horizontal dispense position.	
6020	Invalid dispense height.	
6021	Invalid plate clear height.	
6022	Invalid column selection value (must be 0 or 1).	
6023	Invalid protocol step type.	
6024	The Definition String contains invalid data.	
6025	Manifold conflict between protocol requirements and instrument configuration.	Change the Washer Manifold or change the Instrument Setting. See Appendix B in the operator's manual.
6026	Valve module conflict between protocol requirements and instrument configuration.	Make sure the Buffer Switching setting matches your instrument; see Instrument Settings .
6028	Filter washer conflict between protocol requirements and instrument configuration.	Service Only. Contact BioTek TAC.

Error Code	Description	Help
6031	Cannot use a 96-well plate with a 192-tube manifold.	Modify the Plate Type or Change the Washer Manifold.
6032	Downloading Protocols is not supported.	Service Only. Contact BioTek TAC.
6040	Invalid baud rate	Service Only. Contact BioTek TAC. These codes indicate an unexpected software error that cannot be fixed without BioTek support.
6041	Invalid data bits selection	
6042	Invalid stop bits selection	
6043	Invalid parity selection	
6044	Serial port error	Fix the COM port setting. Check the cabling. Click the Port link and use the drop-down menu to see all active ports. Customize the Predefined Protocols to avoid this error in future. When controlling the BioStack with the LHC, make sure the instrument's BioStack setting is Manual .
6045	Serial write error	
6046	Serial read error	
6047	Checksum error	Contact BioTek TAC.
6048	Serial NAK error	Make sure the COM port setting is correct and the cable is properly connected. Restart the instrument. If error reoccurs, contact BioTek TAC.
6049	Excess data, or not enough data, received.	To correct these errors: <ul style="list-style-type: none"> • Reset the instrument. • Check cables, plug in only one communication cable at a time: USB or serial. • Try running a different protocol. If error reoccurs, contact BioTek TAC.
6050	Invalid message header	
6051	Invalid message object	
6052	Invalid message body size	
6053	Serial message timeout	
6054	Port handle error	
6055	Read timeout value is invalid.	

Error Code	Description	Help
6056	Unauthorized to open the COM port	Make sure the COM port setting is correct and the cable is properly connected. Restart the instrument. If error reoccurs, contact BioTek TAC.
6057	Out-of-range parameter for the open port function.	
6058	Unable to open the COM port.	
6059	Unable to clear the transmission buffer.	
6060	Unable to close the port.	
6061	Port is no longer available.	
6062	Unhandled exception while transmitting message	Contact BioTek TAC
6063	The selected plate type is not allowed with this protocol step	Modify the protocol to change the plate type.
6065	Too few data bytes received from the instrument	Contact BioTek TAC.
6066	Ultrasonic cleaning assembly is not installed	The protocol may have been created for a different instrument. Make sure the instrument settings match the current instrument and modify the protocol.
6074	Invalid Y-axis offset value	Service Only. Contact BioTek TAC. These codes indicate an unexpected software error that cannot be fixed without BioTek support.
6075	Invalid Z-axis offset value	
6076	Vacuum filtration not allowed with 1536-well plates.	Modify the protocol to change the plate type.
6087	'Move carrier home' is required when duration exceeds 1 minute.	Contact BioTek TAC

Error Code	Description	Help
6088	Invalid Shake/Soak options selected	<p data-bbox="850 306 1117 369">Service Only. Contact BioTek TAC.</p> <p data-bbox="850 420 1325 520">These codes indicate an unexpected software error that cannot be fixed without BioTek support.</p>
6089	Invalid Shake Intensity selected	
6090	Invalid Washer buffer selected	
6091	Invalid Washer Aspirate Delay value	
6092	Invalid Washer Aspirate Travel Rate value	
6093	Invalid Wash Cycles value	
6094	Invalid Wash format selected	
6095	Invalid Wash Sectors selected	
6096	Wash Aspirate Delay value is required.	
6100	This functionality requires the software to be registered.	<p data-bbox="834 915 1308 1016">You must register the software with BioTek. Select Help>Register Software.</p>

Appendix B

Warnings, Hazards, Precautions Avertissements, Risques et Précautions

This document contains information on warnings, hazards, and precautions that may apply to the BioTek product(s) you have purchased. BioTek provides this appendix to ensure that you have the information you need to safely operate our products. If you have any questions, please contact BioTek directly or your local BioTek representative. Refer to the operator's manual for contact information.

Ce document contient des informations sur les avertissements, les risques et les précautions qui peuvent s'appliquer aux différents produits BioTek que vous avez achetés. BioTek propose ce document en plusieurs langues afin de s'assurer que vous avez les informations dont vous avez besoin pour manipuler en toute sécurité tous nos produits. Si vous avez des questions, veuillez contacter BioTek directement ou votre représentant local BioTek. Reportez-vous au manuel de l'utilisateur pour obtenir des informations sur ou nous contacter.

Some Warnings, Hazards, and Precautions are instrument-specific. Where applicable, the information is preceded by the instrument type (e.g., "Detection", "Liquid Handling") or model (e.g., "EL406", "BioStack"). If there is no such indication, the information applies to most or all products.

Certaines mises en garde, risques et précautions sont spécifiques à chaque appareil. Le cas échéant, l'information est précédée par la catégorie d'instruments (par exemple, "Détection", "Liquid Handling") ou modèle (par exemple, "EL406", "BioStack"). S'il n'y a pas une telle indication, l'information s'applique à tous les produits.

Warnings, Avertissements



Operate the instrument on a level, stable surface away from excessive humidity.

Faites fonctionner l'appareil sur une surface plate et stable à l'abri de l'humidité excessive.

When operated in a safe environment according to the instructions in this document, there are no known hazards associated with the instrument. However, the operator should be aware of certain situations that could result in serious injury; these vary depending on the instrument type. See **Hazards** and **Precautions**.

Lorsque l'appareil est utilisé dans un environnement sûr, selon les instructions de ce document, il n'existe pas de risques connus associés à l'instrument. Toutefois, l'opérateur doit être conscient de certaines situations qui pourraient entraîner des blessures graves variables en fonction du type d'instrument. Voir **Dangers** et **Précautions**.

Detection:

Bright sunlight or strong incandescent light can reduce the linear performance range of the instrument.

Measurement values may be affected by extraneous particles (such as dust) in the microplate wells. A clean work area is necessary to ensure accurate readings.

Détection:

La lumière du soleil ou une forte lumière incandescente peut réduire la gamme de puissance linéaire de l'instrument.

Les valeurs de mesure peuvent être affectées par des particules étrangères (comme la poussière) dans le puits de la microplaque. Un espace de travail propre est nécessaire pour assurer des lectures précises.

Liquid Handling:

Strict adherence to instrument maintenance and qualification procedures is required to ensure accurate dispense volumes and risk-free operation.

Manipulations des liquides:

Le strict respect de maintenance des instruments et des procédures de qualification est nécessaire pour assurer l'exactitude des volumes de distribution et un fonctionnement sans risque.

Hazards, Dangers



Warning! Internal Voltage. Always turn off the power switch and unplug the power supply before cleaning the outer surface of the instrument or, for some readers, removing its top case.

Attention! Tension interne. Toujours mettre l'appareil hors tension et débrancher le bloc d'alimentation avant de nettoyer la surface extérieure de l'instrument ou, pour certains lecteurs, en enlevant le capot supérieur.



Warning! Power Rating. The instrument's power supply or power cord must be connected to a power receptacle that provides voltage and current within the specified rating for the system. Use of an incompatible power receptacle may produce electrical shock and fire hazards.

Attention! Puissance. La puissance du cordon d'alimentation de l'appareil ou l'alimentation doit être branchée à une prise de courant qui fournit la tension. La valeur spécifiée pour le système doit être impérativement utilisée. L'utilisation d'une prise de courant incompatible peut produire un choc électrique et un incendie.

Warning! Electrical Grounding. Never use a plug adapter to connect primary power to the external power supply or the instrument. Use of an adapter disconnects the utility ground, creating a severe shock hazard. Always connect the power cord directly to an appropriate receptacle with a functional ground.

Attention! Prise terre. Ne jamais utiliser un adaptateur pour connecter l'alimentation primaire du bloc d'alimentation externe ou de l'appareil. L'utilisation d'un adaptateur se déconnecte de la prise terre, créant un risque d'électrocution grave. Toujours brancher le cordon d'alimentation directement à une prise terre.

Warning! Service. Only qualified technical personnel should perform service procedures on internal components.

Attention! Service. Seul un personnel technique qualifié doit effectuer les procédures d'entretien des composants internes.

Warning! Accessories. Only accessories that meet the manufacturer's specifications shall be used with the instrument.

Attention! Accessoires. Seuls les accessoires qui répondent aux spécifications du fabricant doivent être utilisés avec l'instrument.

Warning! Lubricants. For instruments that have an exposed rail for the plate carrier or no plate chamber access door, do not apply lubricants to the microplate carrier or carrier track. Lubricant on the carrier mechanism or components in the carrier compartment will attract dust and other particles, which may obstruct the carrier path and cause the instrument to produce an error.

Attention! Lubrifiants. Pour les instruments avec un rail exposé pour support de plaques ou sans porte d'accès à l'intérieur de la plaque, ne pas appliquer de lubrifiants pour microplaques ou piste de support de microplaques. Un lubrifiant sur le mécanisme de support ou des composants dans le compartiment transporteur peut attirer la poussière et d'autres particules qui peuvent obstruer la voie de transport et l'instrument peut être amené à produire une erreur.

Warning! For instruments that weigh more than 40 lb (18 kg), use two people when lifting and carrying the instrument.

Attention! Pour les instruments qui pèsent plus de 40 lb (18 kg), il faut deux personnes pour déplacer l'instrument.

Warning! Liquids. Avoid spilling liquids on the instrument; fluid seepage into internal components creates a potential for shock hazard or instrument damage. If a spill occurs while a program is running, abort the program and turn off the instrument. Wipe up all spills immediately. Do not operate the instrument if internal components have been exposed to fluid.

Attention! Liquides. Évitez de renverser des liquides sur l'instrument; l'infiltration de liquide dans les composants internes crée un risque d'électrocution ou d'endommager l'instrument. Si un liquide est accidentellement renversé sur l'appareil lorsqu'un programme est en cours d'exécution, interrompez le programme et éteignez l'appareil. Essuyez immédiatement toutes les éclaboussures. Ne pas faire fonctionner l'appareil si les composants internes ont été exposés à des fluides.

Warning! Unspecified Use. Failure to operate the equipment according to the guidelines and safeguards specified in this manual could result in a hazardous condition.

Attention! Utilisation non spécifié. Si l'appareil n'est pas utilisé selon les lignes directrices et les garanties spécifiées dans ce manuel, vous risquez d'entraîner une situation dangereuse.

Warning! Software Quality Control. The operator must follow the manufacturer's assay package insert when modifying software parameters and establishing reading, washing, or dispensing methods. **Failure to conduct quality control checks could result in erroneous test data.**

Attention! Contrôle qualité du logiciel. L'opérateur doit suivre les conseils du fabricant de dosage lors de la modification des paramètres du logiciel, de la lecture, du lavage, de la distribution ou des méthodes. **L'omission d'effectuer des contrôles de qualité pourrait se traduire par des données de test erronés.**



Warning! Potential Biohazards. Some assays or specimens may pose a biohazard. This hazard is noted by the symbol shown here. Adequate safety precautions should be taken as outlined in the assay's package insert. Always wear safety glasses and appropriate protective equipment, such as chemically resistant rubber gloves and apron.

Attention! Risques biologiques potentiels. Certains tests ou spécimens peuvent présenter un risque biologique. Ce risque est indiqué par le symbole ci-contre. Les précautions de sécurité adéquates doivent être prises, comme indiqué dans la notice du test en question. Toujours porter des lunettes de sécurité et équipements de protection appropriés, notamment des gants en caoutchouc, résistant aux produits chimiques et un tablier.



Warning! Pinch Hazard. Some areas of this instrument, its components, and/or accessories can present pinch hazards when the instrument is operating. The module is marked with one of the symbols shown here. Keep hands/fingers clear of these areas when the instrument is operating.



Attention! Pincement. Certaines zones de cet instrument, ses composants et / ou accessoires peuvent présenter des dangers potentiels de pincement lorsque l'appareil est en fonction. Le module est repéré avec l'un des symboles illustrés ici. Gardez les mains / doigts hors de ces zones lorsque l'appareil est en fonction.



Warning! Hot Surface. For readers that use a tungsten lamp, the lamp assembly is hot when the instrument is turned on. Turn off the reader and allow the lamp to cool down before attempting to replace it.

Attention! Surface chaude. Pour les lecteurs avec lampe au tungstène, la lampe est très chaude lorsque l'appareil est allumé. Éteignez le lecteur et laissez la lampe refroidir avant d'essayer de la remplacer.

Detection:

Warning! Reader Data Reduction Protocol. For readers with keypads: The onboard assay software will flag properly defined controls when they are out of range. The software will present the data with the appropriate error flags for the operator to determine control and assay validity. **For readers operated via computer control:** No limits are applied to the raw measurement data. All information exported via computer control must be thoroughly analyzed by the operator.

Détection:

Attention! Protocole pour lecteur de réduction des données. Pour les lecteurs avec claviers: Le logiciel d'analyse inclus dans ces lecteurs, signalera lorsque les touches-contrôle sont hors de portée. Le logiciel signalera sur les données avec les drapeaux d'erreur appropriés afin que l'utilisateur puisse déterminer le contrôle et la validité du dosage. **Pour les lecteurs pilotés via contrôle de l'ordinateur:** Aucune limite n'est appliquée aux données brutes de mesure. Toutes les informations exportées via contrôle de l'ordinateur doivent être soigneusement analysés par l'opérateur.



Instruments with Barcode Scanners:

Warning! Laser Beam. Serious eye injury may occur if you stare directly into the laser beam of the barcode scanner during operation of the scanner. This hazard is noted by the symbol shown here. Do not look directly into the laser beam during operation of the scanner.

Instruments avec lecteur de codes barres:

Attention! Rayon laser. Des lésions oculaires graves peuvent se produire si vous regarder directement dans le faisceau laser du lecteur de codes barres pendant le fonctionnement du scanner. Ce risque est noté par le symbole ci-contre. Ne pas regarder directement dans le faisceau laser pendant le fonctionnement du scanner.

Liquid Handling:

Warning! Ultrasonic Energy. Ultrasonic energy is present in the ultrasonic cleaner reservoir (if equipped) when AUTOCLEAN programs are running. Avoid putting your fingers in the bath. Ultrasonic energy, in this application, can be destructive to human tissue.

Manipulations des liquides:

Attention! Energie ultrasonique. L'énergie ultrasonique est présente dans le réservoir nettoyeur à ultrasons (le cas échéant) lorsque les programmes en cours d'exécution sont AUTOCLEAN. Évitez de mettre vos doigts dans le bain. L'énergie ultrasonique, dans cette application, peut être gravement dangereux pour la peau.

ELx405:

Warning! Direct Drain Waste. If installed, the direct drain waste system pumps waste fluids from the washer directly into a sink or tank and potentially into public waste water systems. Because the waste may be a biohazard, you must ensure that you are in compliance with your local or national government's laws regarding safe disposal of the waste.

Attention! Déchets de vidange directe. Si la pompe de vidange est installée sur votre appareil (en Option sur certains appareils) la pompe aspire les déchets directement du laveur et les reverse dans un évier ou une cuve et potentiellement dans les systèmes publics de traitement des eaux usées. Du fait que ces déchets peuvent potentiellement être nocifs, vous devez vous assurer que vous êtes en conformité avec les lois de votre gouvernement local ou national concernant l'élimination sans danger des déchets.

Precision:

Warning! Moving Parts. The symbol on the pipette shuttle indicates a potential for personal injury. At any given time during instrument operation, the pipette shuttle may be moving. There are potential pinch points on the mechanism and opportunities for skin puncture with the pipette tips. Keep hands completely out of the way of the pipette shuttle when the instrument is in operation.

Attention! Pièces en mouvement. Le symbole sur la navette-pipette indique un risque de blessure. À tout moment de l'utilisation, la navette-pipette peut être en mouvement. Il y a des points de pincement potentiels sur le mécanisme et les possibilités de perforation de la peau avec les embouts de pipette. Gardez les mains complètement hors de la voie de la navette-pipette lorsque l'appareil est en fonction.

Warning! Liquids. Do not attempt to remove or replace supplies outside the expected supply replenishment windows. Interruptions to instrument movement can result in spilled fluids.

Attention! Liquides. Ne tentez pas de retirer ou de remplacer les consommables en dehors des ouvertures prévues de réapprovisionnement. Les secousses apportées à l'instrument peuvent entraîner des renversements de fluides.



Instruments with Lasers and/or LED Lights:

Warning! Lasers/LED Lights. Serious eye injury may occur if you stare directly at the laser/LED during operation of the light. This hazard is noted by the symbol shown here.

Instruments avec des lasers et/ou lumières LED:

Attention! Lasers/lumières LED. Des lésions oculaires graves peuvent se produire si vous regarder directement le laser / LED pendant le fonctionnement de la lumière. Ce risque est noté par le symbole ci-contre.

Precautions, Précautions



Caution: Service. The instrument should be serviced by BioTek authorized personnel. Only qualified technical personnel should perform service procedures on internal components.

Attention: Service. L'appareil doit être réparé par un personnel autorisé BioTek. Seul le personnel technique qualifié doit effectuer les procédures d'entretien des composants internes.

Caution: Spare Parts. Only approved spare parts should be used for maintenance. The use of unapproved spare parts and accessories may result in a loss of warranty and potentially impair instrument performance or cause damage to the instrument.

Attention: Pièces détachées. Seulement des pièces détachées approuvées doivent être utilisées pour l'entretien. L'utilisation de pièces et accessoires non approuvés peut entraîner une annulation de la garantie et peut compromettre la performance de l'appareil ou causer des dommages à l'appareil.

Caution: Environmental Conditions. Do not expose the instrument to temperature extremes. For proper operation, ambient temperatures should remain within the range listed in the **Specifications** section in the operator's manual. Performance may be adversely affected if temperatures fluctuate above or below this range. Storage temperature limits are broader.

Attention: Conditions environnementales. Ne pas exposer l'appareil à des températures extrêmes. Pour un bon fonctionnement, les températures ambiantes doivent rester dans les limites indiquées dans la section **Caractéristiques** techniques du manuel de l'opérateur. La performance peut être affectée si la température fluctue au-dessus ou en dessous de cette fourchette. La limite de température de stockage est plus flexible.

Caution: Sodium Hypochlorite. Do not expose any part of the instrument to the recommended diluted sodium hypochlorite solution (bleach) for more than 20 minutes. Prolonged contact may damage the instrument surfaces. Be certain to rinse and thoroughly wipe all surfaces.

Attention: L'hypochlorite de sodium. Ne pas exposer les composants de l'instrument à la solution recommandée, l'hypochlorite de sodium dilué (eau de Javel) pour plus de 20 minutes. Un contact prolongé peut endommager les surfaces de l'appareil. Assurez-vous de rincer et essuyer soigneusement toutes les surfaces.

Caution: Disposal. This instrument contains printed circuit boards and wiring with lead solder. Dispose of the instrument according to Directive 2002/96/EC, "on waste electrical and electronic equipment (WEEE)," or local ordinances.

Attention: L'élimination. Cet instrument contient des circuits imprimés et un câblage avec une soudure au plomb. Éliminer l'instrument conformément à la directive 2002/96/CE, «déchets d'équipements électriques et électroniques (DEEE),» ou selon les lois locales.

Caution: Warranty. Failure to follow preventive maintenance procedures may void the warranty.

Attention: Garantie. Le non-respect des procédures de maintenance préventive peut annuler la garantie.

Caution: Shipping Hardware. All shipping hardware must be removed before operating the instrument and reinstalled before repackaging the instrument for shipment.

Attention: Hardware expédition. Tout le matériel de transport doivent être retirés avant de faire fonctionner l'appareil et réinstallé si expédition nécessaire.

Caution: Electromagnetic Environment. Per EN 61326-2-6 it is the user's responsibility to ensure that a compatible electromagnetic environment for this instrument is provided and maintained in order that the device will perform as intended.

Attention: L'environnement électromagnétique. En conformité avec la loi EN 61326-2-6 il est de la responsabilité de l'utilisateur de s'assurer que l'environnement électromagnétique compatible pour cet appareil est fourni et entretenu, afin que le dispositif fonctionne comme prévu.

Caution: Electromagnetic Compatibility. Do not use this device in close proximity to sources of strong electromagnetic radiation (e.g., unshielded intentional RF sources), because these may interfere with the proper operation.

Attention: Compatibilité électromagnétique. Ne pas utiliser cet appareil à proximité de sources de rayonnements électromagnétiques intenses (par exemple, les sources RF non blindés intentionnellement), car ceux-ci peuvent interférer avec le bon fonctionnement de l'appareil.

Liquid Handling/De traitement des liquides

Caution: Buffer Solution. Although many precautions have been taken to ensure that the instrument is as corrosion-proof as possible, the instrument is not sealed and liquids can seep into sensitive components. Make sure that any spilled buffer solution is wiped off the instrument. Prolonged exposure to salt solution may corrode parts of the microplate carrier, movement rail, springs, and other hardware.

Attention: Solution tampon. Bien que de nombreuses précautions ont été prises pour s'assurer que l'instrument est aussi résistant à la corrosion que possible, l'instrument n'est pas étanche et les liquides peuvent s'infiltrer dans les composants sensibles. Assurez-vous que toute solution tampon déversée est essuyée. Une exposition prolongée à la solution salée peut être corrosive aux microplaques, aux rails de l'appareil, aux ressorts et d'autres matériels.

Caution: Chemical Compatibility. Some chemicals may cause irreparable damage to the instrument. The following chemicals have been deemed safe for use in the instrument: buffer solutions (such as PBS), saline, surfactants, deionized water, 70% ethyl, isopropyl, or methyl alcohol, 40% formaldehyde, and 20% sodium hydroxide. Never use acetic acid, DMSO, or other organic solvents. These chemicals may cause severe damage to the instrument. **ELx405:** Use of wash buffers containing acetic acid is limited to instruments with PN 68098 Teflon® valves. Contact BioTek for more information and prior to using other questionable chemicals.

Attention: Compatibilité chimique. Certains produits chimiques peuvent endommager à jamais l'appareil. Les produits chimiques suivants ont été jugés sûrs pour une utilisation avec l'appareil: des solutions tampons (tels que PBS), les solutions salines, des agents tensio-actifs, eau déminéralisée, éthyle, isopropyle 70%, ou de l'alcool de méthyle, formaldéhyde 40%, et de l'hydroxyde de sodium à 20%. Ne jamais utiliser de l'acide acétique, le DMSO, ou d'autres solvants organiques. Ces produits chimiques peuvent causer de graves endommagement à l'appareil. **ELx405:** Utilisation des tampons de lavage contenant de l'acide acétique est limitée aux instruments avec les vannes Teflon® PN 68098. Contactez BioTek pour plus d'informations et avant d'utiliser d'autres produits chimiques douteux.

Caution: Bovine Serum Albumin. Solutions containing proteins, such as bovine serum albumin (BSA), will compromise the instrument's performance over time unless a strict maintenance protocol is adhered to. See **Maintenance** procedures regarding BSA.

Attention: Sérum albumine bovine. Solutions contenant des protéines, comme l'albumine sérique bovine (BSA), va compromettre les performances de l'instrument au fil du temps, sauf si un protocole de maintenance stricte est respectée. Voir les procédures **de maintenance** concernant BSA.

Caution: Power Supply. Only use the power supply shipped with the instrument, and operate it within the range of line voltages listed on it.

Attention: Alimentation. Utilisez uniquement le bloc d'alimentation livré avec l'appareil et le faire fonctionner dans la plage de tension de ligne figurant sur celui-ci.

Caution: Do not run the MicroFlo Select without a cassette installed on the pump.

Attention: Ne pas faire fonctionner la sélection MicroFlo sans cassette installé sur la pompe.

Instruments with Barcode Scanners/ Instruments de Lecteurs de code-barres

Caution: Barcode Scanner Mirror. Do not scratch or damage the mirror when unpacking or installing the barcode scanner.

Attention: Miroir lecteur de code-barres. Ne pas rayer ou endommager le miroir lors du déballage ou lors de l'installation du lecteur de code-barres.

BioStack

Caution: Aligning Posts. When installing the BioStack's four aligning posts, use caution not to cross thread these parts. **Finger-tighten only!** See the installation instructions.

Attention: Messages pour alignements. Pour l'installation des quatre blocques BioStack, faites attention à ne pas entremêler les fils de ces pièces. **Serrer seulement avec les doigts!** Voir les instructions d'installation.

ELx405/ELx406

Caution: Waste Sensor Port. (For customers who have purchased the BioStack Microplate Stacker for use with the instrument.) Although the waste sensor port on the back of the instrument is the same type as the 24-VDC power connector on the back of the BioStack, if an external 24-VDC power supply is plugged into the instrument's port, **it will permanently damage internal components.**

Attention: Port du capteur déchets. (Pour les clients qui ont acheté le BioStack microplaques Stacker pour une utilisation avec l'instrument.) Bien que le port du capteur déchets à l'arrière de l'appareil soit du même type que le connecteur d'alimentation 24 V cc sur le dos de la BioStack, si une alimentation externe 24 VDC est branché dans le port de l'instrument, **les composants internes seront endommagés à jamais .**

Index

1	
192-Tube Manifold.....	10,105,113

3	
384-well plates.....	50,111
Manifold selection.....	105

9	
96-Tube Manifold.....	10,105
Evacuation test.....	158
Setting.....	107

A	
Accessories.....	7
Accessory Outlet.....	10
Adjust Utility.....	60,108-109
Aspirate fluid.....	40
how to delay.....	87
travel rates.....	68
Assays	
Biomagnetic separation.....	89
Bottom/vacuum filtration.....	97
Cellular.....	84
AutoClean.....	125-126
AutoPrime.....	121-123
Washer.....	105,123
AutoPrime Interval.....	122
Average Residual Volume.....	10

B	
Basic operation.....	38
BioStack	
How to configure/operate.....	81
BioTek's Customer Resource Center...12	
BioTek's Ultrasonic Advantage.....	125
Bottles	
Clean filter.....	130

Connection.....	18
Bottom Wash.....	70
BSA.....	124-125
Buffer Switching.....	57
installation.....	22
QC test.....	160

C	
Carrier setting.....	107
Cell Wash.....	68,84
aspirate rate.....	68
Strategy to preserve cells.....	85
Changing the wash manifold.....	107
Cleaning.....	125,128,132,140
Removing proteins.....	124
Columns	
Dispensing to.....	50
COM Port.....	26,42,55,57
CommonAppDataFolder.....	56
Communication Errors.....	188
Copy a protocol.....	52
CW+ Control.....	84-85,87,107

D	
Decontaminate.....	138
Manifold and tubing.....	140,143
Vacuum filtration carrier.....	142
Deionized water.....	ix,117,128
Delay after Dispense.....	87
Delay Aspiration.....	87
Delay/pause processing.....	66
Dispense	
To specific columns.....	50
Dispense Pattern.....	111
Dispense Precision.....	11
Dispense Precision and Accuracy Test	
For 96-tube.....	157

Dispense Precision Test		Name a protocol	49
For 192-tube	161	Shake the plate	51
Dispense to certain wells		Humidity limits	9
Keypad control	50		
Distilled water	ix,117,128	I	
Download protocols	62		
E			
Empty priming trough	46	Incubate a plate at room tem- perature	51,66
Enter negative numbers	52	Instrument Settings	56-57
Error codes	180,192,200	Defining	26
Evacuation Efficiency	10	Instrument Utilities	122
Evacuation Efficiency Test		Adjust Utility	108
About	154	AutoPrime	122
For 96-tube	158	Verify sensor	72
F		Interface Software	56
		Intermediate Waste System	
Filter plate assays		Installing Vacuum Filtration	99
Install hardware	99	IQ-OQ-PQ	8
Final Aspirate	40,69-70	schedule	149
Flow Detection	105,196	K	
Fluid Detection	105,196		
Fluid Supply		Keypad	46,52
Clean filter	130	How to name a protocol	49
washer	22	L	
G			
		Labware	9
General Settings	27	LCD	46
H		level sensor	3
		Level sensor	72
H2O	ix,117,128	LHC	56
Hardware	9	Protocols explained	57
High Flow vacuum pump		Liquid test solutions	8
Caution	xiii	Long shutdown procedure	143
Horizontal aspirate position	187	Low Flow	84
How To		Low vacuum	183
Change the plate carrier setting	107	M	
Change the plate clearance setting	108		
Change the washer manifold set- ting	107	Magnet Height Offset	93,105,108
enter a negative value	52	Magnetic bead assays	89
		Maintenance	119,128
		Removing proteins	124
		Wash manifolds	131

Manifold		Priming trough	
Change/Install	145	how to empty	46
Manifold Selection	105	Processing patterns	111
Manifold Type	10	Protein	
Microplate carrier		Preventing clogging	124
Vacuum filtration	103	Protocol	
Microplates		Copying	52
supported types	9	Deleting	52
Mix the plate contents	51	Input a negative number	52
Multiple instruments	57	Naming	49
		Shake and Soak	51
		Protocols	
N		Customize	41,56
Negative numbers		Predefine	56
how to input	52		
		Q	
P		QC	56
Package contents	5	QC testing	152
Packing materials	32	Qualification	
Partial plate	112	Instrument	29
Parts listing	5,7	Which tests to perform	152
Pause or delay action	66	Qualification schedule	149
Performance Specifications	10	Quick Wash	47-48
Performance verification			
After installation	29	R	
Physical Specifications	9	Rates	
Plate carrier		Aspirate travel rate	68
Vacuum filtration	103	Washer flow rates	62
Plate Carrier setting	107	Replace the Verify Test Plate	134
Plate Clearance setting	108	Resize	38
Plate geometry diagram	111	window	38
Plate Map	50	Returning the instrument	32
Plate Type	111	Robotics integrators	82
Defining	47,50		
supported	9	S	
Port link	42,55,57	Self-test	149
Power Supply	9	Sensors	106
Power users	56	serial port	25,82,180
Pre-Dispense	67	Service Functions	107
Prevent fluid loss during wash	87	Shake intensity	66
Prime		Shake the plate	51
tips	67		

Shake/Soak parameters.....	66	Vacuum Filtration.....	129,133
Shipping		QC test.....	165
preparation for.....	143	Vacuum Filtration Carrier	
Prepare for.....	144	decontaminate.....	142
Size and weight.....	9	replace gasket.....	146
Soak.....	51,60,67	Vacuum on based on volume.....	87
Soak step.....	66	Valve module	
Soak, steep the plate contents.....	51	installation.....	22
Sonicator.....	3,125-126	Verification	
Special plate types.....	111	instrument testing.....	152
Specifications.....	9-10	Verify Technology.....	3,72
Storage.....	144	maintenance.....	133
preparation for.....	143	qualify.....	167
Suspend the beads during the wash...51		replace the test plate.....	134
System Error Codes.....	192		
		W	
T			
Terg-A-Zyme.....	125	Wash	
Test solutions.....	157	about.....	38
Tests		extra turbulence.....	70
which tests to perform.....	152	Gentle, cell wash.....	84
Tip priming.....	67	Magnetic beads.....	89
Transfer protocols.....	62	Polystyrene beads.....	97
Troubleshooting.....	180	Quick.....	47
Instrument Error Codes.....	192	Wash Manifold onboard setting.....	107
LHC Error Codes.....	200	Wash the Plate	
Washer problems.....	183	192-tube wash pattern.....	112
Tubes		96-tube wash pattern for 384-well	112
Installation of.....	18	plate.....	
Turn off vacuum pump.....	46	Washer	
		Fixing problems.....	183
U		Protocol parameters listing.....	62
Ultrasonic Advantage.....	125	Washer Dispense step.....	67
Upload protocols.....	62	Washer Flow Rates.....	68
USB.....	180,189	Washer Prime step.....	39,123
		Washer Manifold	
V		AutoPrime.....	123
Vacuum		Washer Settings.....	105
Low.....	183	Waste system	
turn off.....	46	Installation.....	19
Vacuum Dissipate.....	27	sensor.....	106
		Water.....	ix,117,128
		Windows Common Applications Data56	

Folder.....	
Windows® 7.....	56
Windows® Vista.....	56
Windows® XP.....	56
Worksheet	
Test results	165

405 TS/LS Chemical Compatibility Chart

Table 1: Material/Where Used List

#	Material	Where Used
1	304 Stainless Steel	Inlet screen, feeder tube to manifold, vacuum switch
2	316 Stainless Steel	Dispense and aspirate tubes, feeder tube to manifold, spring in bottle fittings
3	Acetal	Vacuum filtration plug
4	Aluminum (anodized)	Microplate carrier, vacuum filtration carrier grill and retainer
5	CPVC (Chlorinated Polyvinyl chloride)	Manifold, vacuum filtration carrier
6	Nylon	Inlet fitting, vacuum switch adjustment screw, carrier leveling feet
7	PTFE (polytetrafluoroethylene) Teflon	Optional check valves (PN: 68098) for fluid pump, direct drain pump, fluid path
8	EPDM (Ethylene Propylene)	Inlet valve, vacuum filtration 3-way valves, vacuum switch diaphragm
9	Neoprene	Manifold channel-end seals
10	PPO (polyphenylene Oxide) Noryl®	Vacuum switch internal disc
11	Polycarbonate	Vacuum switch body, Vacuum filtration intermediate waste bottle, direct drain intermediate waste bottle
12	Polyethylene	Buffer bottle
13	Polypropylene	Outlet fitting, fittings in bottles, inline fittings, float ball, bottle caps, vacuum filtration module bulkhead fittings
14	Polystyrene	Flow sensor, mist shield, assay plates
15	PVC (Polyvinyl chloride)	Inlet valve, waste sensor, flow sensor ball retainer, waste tubing, vacuum filtration plug
16	PPS (polyphenylenesulfide) Ryton®	Fluid pump, vacuum filtration plug, inlet valve (serial # less than 207137)
17	Thermoplastic elastomer Santoprene®	Fluid pump check valves
18	Silicone	Inlet tubing, outlet tubing, o-rings, vacuum filtration carrier gasket, vacuum filtration module tubing
19	Ultem (polyetherimide)	Outlet valve, CW inlet valve, vacuum filtration module valves
20	Viton	Outlet valve, CW inlet valve

Table 2: Chemical Compatibility Ratings

Key	1	2	3	4	5	6	7	8	9	10	11	12	13	14	15	16	17	18	19	20
	304 S.Steel	316 S.Steel	Acetal	Aluminum	CPVC	Nylon	PTFE Teflon	EPDM	Neoprene	PPO (Noryl)	Polycarbon.	Polyethylene	Polypropyl.	Polystyrene	PVC	PPS Ryton	Santoprene	Silicone	Ultem	Viton
Chemical	1	2	3	4	5	6	7	8	9	10	11	12	13	14	15	16	17	18	19	20
Acetic Acid, 5%	D	A	D	B	A	D	A	ND	B	A	A	A	A	D	D	A	C	C	A	B
Acetic Anhydride	B	A	D	A	D	A	A	A	B	D	D	C	B	D	D	A	A	A	ND	D
Acetonitrile	ND	A	ND	B	D	A	A	C	ND	ND	D	A	A	D	D	A	ND	D	D	D
Ammonia 10%	A	A	D	A	A	A	A	ND	A	A	D	N	A	B	B	A	A	D	D	D
Benzyl Alcohol	B	B	A	B	A	B	A	B	C	D	ND	A	A	D	D	A	A	A	ND	A
Chloroform	A	A	A	B	D	A	A	D	D	D	D	C	D	D	A	D	D	D	D	A
Detergents 1%	A	A	A	B	A	A	A	A	A	A	A	A	A	A	A	A	B	A	A	A
Dimethylformamide	A	B	D	A	D	A	A	B	D	D	D	C	A	D	D	A	D	A	ND	C
DMSO (Dimethylsulfoxide)	ND	A	ND	A	D	A	A	B	ND	ND	D	A	A	D	D	A	D	C	D	D
Ethyl Alcohol 70%	A	A	A	A	B	A	A	A	A	A	B	B	A	A	B	A	B	B	A	B
Ethylene Oxide	B	B	D	D	C	D	A	C	D	A	C	A	D	C	C	D	ND	A	ND	C
Formaldehyde 37%	A	A	A	B	A	A	A	A	B	A	A	D	A	ND	A	A	ND	C	A	A
Hexane	A	A	A	A	B	B	A	D	B	B	D	A	B	D	B	A	ND	D	A	A
Hydrochloric Acid 20%	D	D	C	D	A	D	A	A	C	B	B	A	B	C	A	D	A	D	A	A
Hydrofluoric Acid 20%	D	D	D	D	C	C	A	C	B	C	D	A	A	ND	B	A	A	D	ND	A
Hydrogen Peroxide 10%	B	B	D	A	A	A	A	A	B	A	A	A	A	A	A	C	ND	A	A	A
Isopropyl Alcohol 70%	B	A	A	A	B	D	A	A	B	A	A	B	A	A	B	A	ND	A	A	A
Methyl Alcohol 70%	A	A	A	A	A	B	A	A	A	A	B	A	A	ND	A	A	B	A	A	A
Methylene Chloride	B	B	B	C	D	C	A	ND	D	D	D	D	B	D	D	A	D	D	D	B
Phosphoric Acid >40%	D	D	D	C	A	B	A	A	B	A	A	A	A	B	B	A	A	C	A	A
Propylene Glycol	B	B	B	B	C	A	A	ND	C	ND	B	A	A	A	C	A	ND	A	ND	A
Sodium Chlorate	A	B	A	C	A	D	A	ND	A	A	A	N	A	ND	A	A	A	C	ND	A
Sodium Hydroxide 20%	B	B	A	D	A	A	A	B	B	A	A	A	A	A	A	A	ND	A	A	A
Sodium Hypochlorite <20%	C	C	D	D	A	D	A	B	C	A	C	A	A	A	A	C	ND	B	B	A
Sodium Hypochlorite 0.5%	B	B	ND	D	A	ND	A	B	C	ND	C	A	A	A	A	C	ND	B	A	A
Sulfuric Acid <10%	D	B	D	B	A	A	A	A	B	A	A	A	A	A	A	A	A	C	A	A
Trichloroethylene	B	B	D	D	D	C	A	ND	D	D	ND	D	C	D	D	A	D	D	D	A
Virkon 10%	ND	A	ND	D	A	A	ND	A	ND	ND	A	A	A	A	A	A	ND	A	ND	A

This ratings information was obtained from several reputable sources and our own experience at BioTek, but your experience may differ due to variations in concentration, temperature, and other factors. Consult the reagent/solvent manufacturer before use to verify its compatibility with instrument components.